

UK

D

- ▶ End Mills and Drills 2018/2019
- ▶ Fräser und Bohrer 2018/2019



Improving Quality Through Innovation
Product of Holland



Improving Quality Through Innovation
Product of Holland

© Copyright SCT Tilburg B.V.

Reprints, even as excerpts, only with permission of SCT Tilburg B.V.. All rights reserved. No claims can be made as a result of mistakes of composition and printing errors. Illustrations, designs and dimensions comply with the latest standards at the time this catalogue was published. Subject to technical changes. The illustrations of the products may not necessarily conform generally and in every detail with the actual appearance.

© Autorrecht SCT Tilburg B.V.

Nachdruck, auch Auszugsweise, ist nur mit unserer Zustimmung gestattet. Alle Rechte vorbehalten. Irrtümer, Satz- oder Druckfehler berechtigen nicht zu irgendwelchen Ansprüchen. Abbildungen, Ausführungen und Maße entsprechen dem neuesten Stand bei Herausgabe dieses Kataloges. Technische Änderungen behalten wir uns vor. Die bildliche Darstellung der Produkte muß nicht in jedem Falle und in allen Einzelheiten dem tatsächlichen Aussehen entsprechen.

Special Carbide Tooling



Special Carbide Tooling is a young and dynamic company which produces solid carbide tools for the metalworking industry. Our product range contains a large variety of standard tools. In addition we also develop and produce special tools according to our customers needs.

Quality and Innovation are the driving forces behind our development and production process. Our mission is to optimize your production processes with our tools. We therefore offer the best possible solution for your specific business application.

Our quality products are being supported by advice to maximize the usability of our tools and achieve extensive tool life. We guarantee that all our products are available from stock and because of our fine logistic organization we can supply our products shortly after receipt of order.

Special Carbide Tooling is a company with modern machinery, qualified craftsmen and carefully selected long-term suppliers. Our quality management is based on ISO9001:2008.

Moreover our Research & Development is focused on continuous improvement and innovation in which we largely invest. In close cooperation with our customers we are constantly working on our goal:

“Improving Quality Through Innovation”

In addition to this we contribute to sustainable development by reducing the negative effects on the environment with a balanced set of measures.

D

Special Carbide Tooling ist ein junges und dynamisches Unternehmen, das sich mit der Produktion von Vollhartmetall-Werkzeugen beschäftigt, die für den Zerspanungsmarkt definiert wurden.

Der Hauptkatalog zeigt ein durchgängiges Produktprogramm an Standardwerkzeugen. Neben den Standard-Katalogwerkzeugen entwickeln und produzieren wir auch Sonderwerkzeuge in Klein- und Großserien.

Qualität und Innovation sind die treibenden Kräfte für unsere Neuentwicklungen und Fertigungsprozesse. Wir konzentrieren uns mit unserem Produktprogramm auf individuelle Lösungen bei der Verfahrenstechnologie. Daher bieten wir für jedes Verfahren eine optimale Zerspanungsanwendung.

Für unsere Kunden sind wir ein zuverlässiges Unternehmen im Bereich Produktion, Beratung und Dienstleistung. Unsere Qualitätsprodukte unterstützen dadurch unseren Kunden bei maximalem wirtschaftlichem Einsatz.

Wir garantieren nahezu 100% Lieferfähigkeit der gesamten Produktpalette. Aufgrund unserer hervorragenden Logistik und Organisation werden alle Produkte innerhalb kürzester Zeit bereitgestellt.

Special Carbide Tooling ist ein Unternehmen mit modernsten Fertigungsanlagen, qualifizierten Fachleuten und sorgfältig ausgewählten Zulieferern.

Unser Qualitätsmanagement basiert auf dem ISO9001:2008 System. Darüber hinaus investieren wir laufend und in großem Umfang in Neuentwicklungen sowie in Schulungen unserer Mitarbeiter. Zusammen mit unseren Kunden steht die Optimierung der Zerspanungsleistung im Fokus.

“Qualität durch Neuentwicklung”

Minimale Belastung der Umwelt ist in unseren Produktionsstätten ein wichtiges Thema und wird deshalb ständig überwacht und verbessert.



Table of contents

Inhaltsverzeichnis

	Quick finder Solid Carbide End Mills / Schnellsuche VHM Fräser	I
	Quick finder Solid Carbide Drills / Schnellsuche VHM Bohrer	II
	Flex Line Solid Carbide End Mills / VHM Fräser	III
	Basic Line Solid Carbide End Mills / VHM Fräser	IV
	Basic Line+ Solid Carbide End Mills / VHM Fräser	V
	Premium Line Solid Carbide End Mills / VHM Fräser	VI
	Ultra-X Line Solid Carbide End Mills / VHM Fräser	VII
	Technical information Solid Carbide End Mills / Technische Informationen VHM Fräser	VIII
	Flex Line Solid Carbide Drills / VHM Bohrer	IX
	Basic Line Solid Carbide Drills / VHM Bohrer	X
	Premium Line Solid Carbide Drills / VHM Bohrer	XI
	Technical information Solid Carbide Drills / Technische Informationen VHM Bohrer	XII
	SCT Tools Eco Plan (SEP) / SCT Tools Eco Plan (SEP)	XIII

UK

▶ Quick finder Solid Carbide End Mills

D

▶ Schnellsuche VHM Fräser

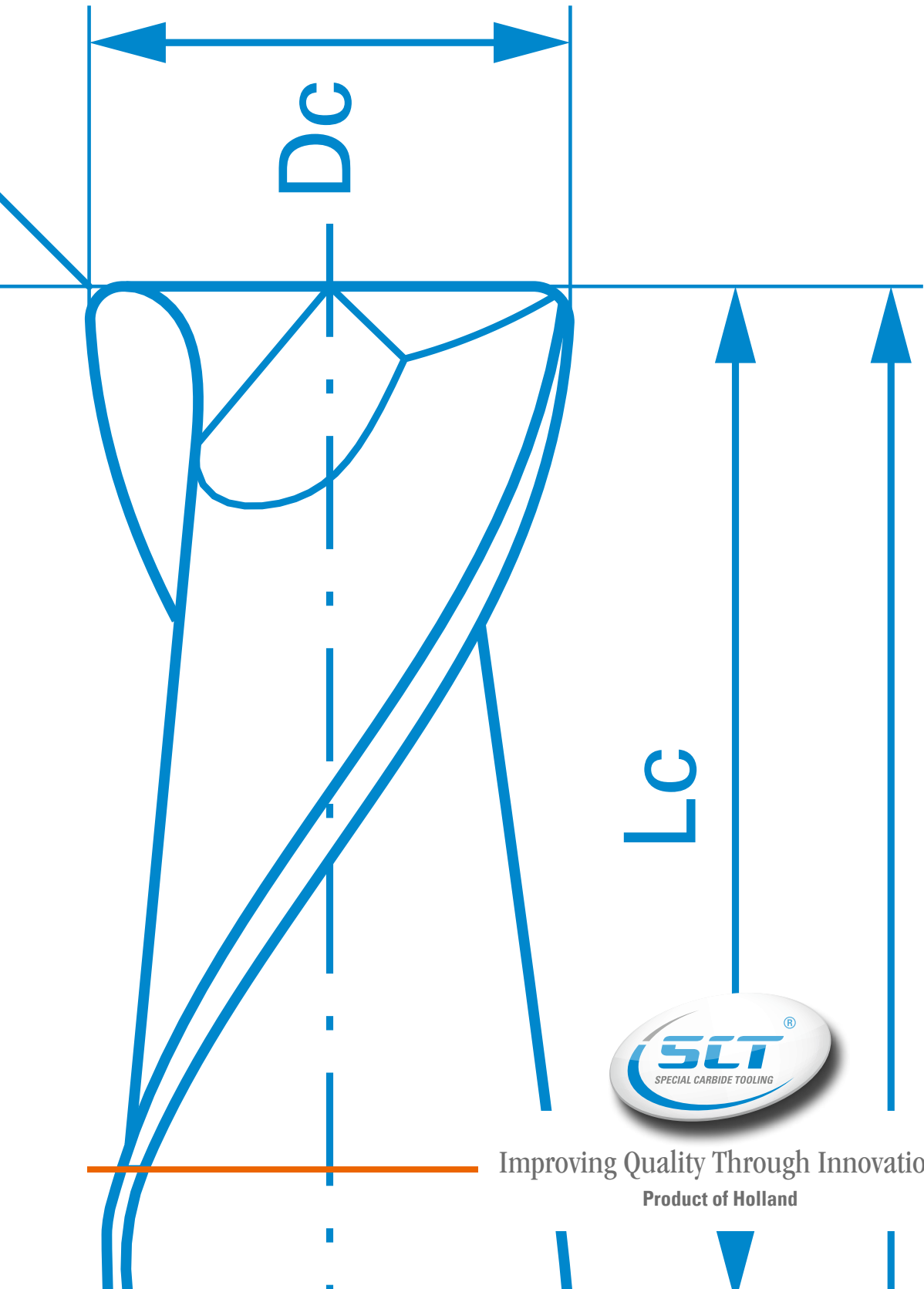

Improving Quality Through Innovation

Product of Holland

Product code description Artikelnummer Beschreibung

End mills / Fräser

BASIC LINE



PREMIUM LINE



EXAMPLE/
BEISPIEL:

BL C 5 L 120 38 V N T10

- BL** Product line - Basic Line / Produktlinie - Basic Line
- C** C = Cylindrical shank / Zylinderschaft
W = Weldon shank / Weldonschaft
- 5** Number of flutes / Zähnezahl
- L** S = Short / kurz
L = Long length / lang
X = Extra long / extra lang
- 120** Cutting diameter $\varnothing 12$ / Schneidendurchmesser $\varnothing 12$
- 38** Helix angle / Drallwinkel
- V** V = Variable helix / Variabler Drall
S = Standard flute / Schlichten
R = Roughing / Schruppen
B = Ballnose / Kugel / Vollradius
U = Semi-rougher / Schrupp-Schlichten
A = Alu / Alu
X = Extra extra long / Extra extra lang
RF = Roughing Fine Pitch / Schruppverzahnung feine Kordel
- N** Tool has a relief / Werkzeug hat einen Freischliff
- T10** Tool has a radius r1.0 / Werkzeug hat einen Radius r1.0

EXAMPLE/
BEISPIEL:













PL S W 4 X 120 45 T20

- PL** Product line - Premium Line / Produktlinie - Premium Line
- S** S = Material group: Steel
Werkstoffgruppe: Stahl
I = Material group: Stainless steel, heat resistant alloys
Werkstoffgruppe: Rostfreier Stahl (VA), hitzebeständige Legierungen
A = Material group: Aluminum and non-ferrous
Werkstoffgruppe: Aluminium und Nichteisenlegierungen
- W** C = Cylindrical shank / Zylinderschaft
W = Weldon shank / Weldonschaft
- 4** Number of flutes / Zähnezahl
- X** Extra long / extra lang
- 120** Cutting diameter $\varnothing 12$ / Schneidendurchmesser
- 45** Helix angle / Drallwinkel
- T20** Tool has a radius r2.0 / Werkzeug hat einen Radius r2.0

Quick finder Solid Carbide End Mills

Schnellsuche VHM Fräser

P

	Product code Artikelnummer	z	Helix / rake angle Spirale / Spanwinkel	Diameter range Durchmesserbereich	End face geometry Stirrfächengeometrie	P1	P2	P3
	FLC2L30S	2		3,0 - 20,0		◆◆	◆	—
	FLC2L30SC	2		3,0 - 20,0		◆◆◆	◆◆	◆
	BLC2S30S	2		3,0 - 20,0		◆◆◆	◆◆	◆◆
	BLC2L30S	2		3,0 - 20,0		◆◆◆	◆◆	◆◆
	PLSC2X30S	2		2,0 - 20,0		◆◆	◆◆◆	◆◆◆
	PLSC2X30T..	2		4,0 - 16,0		◆◆	◆◆◆	◆◆◆
	FLC3S30S	3		0,5 - 12,0		◆◆	◆	—
	FLC3S30SC	3		0,5 - 12,0		◆◆◆	◆◆	◆
	FLC3L30S	3		3,0 - 20,0		◆◆	◆	—
	FLC3L30SC	3		3,0 - 20,0		◆◆◆	◆◆	◆
	BLC3S30S	3		3,0 - 20,0		◆◆◆	◆◆	◆◆
	BLC3L30S	3		3,0 - 20,0		◆◆◆	◆◆	◆◆
	BLC3S45S	3		3,0 - 20,0		◆◆◆	◆◆	◆◆
	BLC3L45S	3		3,0 - 20,0		◆◆◆	◆◆	◆◆
	PLSC3S38V	3		3,0 - 20,0		◆◆	◆◆◆	◆◆◆
	PLSC3L38V	3		3,0 - 20,0		◆◆	◆◆◆	◆◆◆
	FLC4L30S	4		3,0 - 20,0		◆◆	◆	—
	FLC4L30SC	4		3,0 - 20,0		◆◆◆	◆◆	◆
	BLC4S30S	4		3,0 - 20,0		◆◆◆	◆◆	◆◆
	BLC4L30S	4		3,0 - 20,0		◆◆◆	◆◆	◆◆
	BLC4L38V	4		3,0 - 20,0		◆◆◆	◆◆	◆◆

Quick finder Solid Carbide End Mills

Schnellsuche VHM Fräser





























































P

Slot milling Vollnutfräsen	Peripheral milling Umfangfräsen	Roughing Schruppen	Trochoidal Trochoidal	Ramp milling Rampen-Fräsen	Drilling Bohren	3D Milling 3D-Fräsen	Chapter Kapitel	Page Seite
●	-	-	-	-	○	-	III	4 - 5
●	-	-	-	-	○	-	III	6 - 7
●	-	-	-	-	○	-	IV	14 - 15
●	-	-	-	-	○	-	IV	16 - 17
●	-	-	-	-	○	-	VI	4 - 5
●	-	-	-	-	○	●	VI	6 - 7
●	●	-	-	○	●	-	III	8 - 9
●	●	-	-	○	●	-	III	10 - 11
●	●	-	-	○	●	-	III	12 - 13
●	●	-	-	○	●	-	III	14 - 15
●	●	-	-	○	●	-	IV	18 - 19
●	●	-	-	○	●	-	IV	20 - 21
●	●	-	-	○	●	-	IV	22 - 23
●	●	-	-	○	●	-	IV	24 - 25
●	●	-	-	○	●	-	VI	8 - 9
●	●	-	-	○	●	-	VI	10 - 11
-	●	-	-	●	-	-	III	16 - 17
-	●	-	-	●	-	-	III	18 - 19
-	●	-	-	●	-	-	IV	26 - 27
-	●	-	-	●	-	-	IV	28 - 29
●	●	-	●	●	-	-	IV	36 - 37

Quick finder Solid Carbide End Mills

Schnellsuche VHM Fräser

P

	Product code Artikelnummer	z	Helix / rake angle Spirale / Spanwinkel	Diameter range Durchmesserbereich	End face geometry Stirrfächengeometrie	P1	P2	P3
	BLC4S38VN	4		3,0 - 20,0		◆◆◆	◆◆◆	◆◆◆
	BLC4L38VN	4		3,0 - 20,0		◆◆◆	◆◆◆	◆◆◆
	BLC4L38VNT	4		6,0 - 16,0		◆◆◆	◆◆◆	◆◆◆
	BLC4L38VND	4		5,7 - 20,0		◆◆◆	◆◆◆	◆◆◆
	PLSC4L45V	4		3,0 - 25,0		◆◆	◆◆◆	◆◆◆
	PLSC4L55S	4		4,0 - 20,0		◆◆	◆◆◆	◆◆◆
	PLSC4X45T..	4		4,0 - 16,0		◆◆	◆◆◆	◆◆◆
	BLC5L38VN	5		6,0 - 25,0		◆◆◆	◆◆◆	◆◆◆
	BLC5L38VNT	5		6,0 - 20,0		◆◆◆	◆◆◆	◆◆◆
	BLC6L45S	6/8		6,0 - 20,0		◆◆◆	◆◆	◆◆
	BLC6X45S	6/8		6,0 - 20,0		◆◆◆	◆◆	◆◆
	BLC6X45X	6/8		6,0 - 20,0		◆◆◆	◆◆	◆◆
	BLC6L45SN	6/8		6,0 - 20,0		—	◆◆◆	◆◆◆
	PLSC6L50S	6/8		6,0 - 25,0		◆◆	◆◆◆	◆◆◆
	PLSC6X50S	6/8		6,0 - 25,0		◆◆	◆◆◆	◆◆◆
	PLSC6X50T..	6/8		6,0 - 20,0		◆◆	◆◆◆	◆◆◆
	BLC4L45U	4		4,0 - 20,0		◆◆◆	◆◆	◆◆
	BLC4L20R	3/4		6,0 - 20,0		◆◆◆	◆◆	◆◆
	BLC4L45R	3/4/5/6		4,0 - 20,0		◆◆◆	◆◆	◆◆
	BLC4S45RN	3/4/5/6		4,0 - 20,0		◆◆◆	◆◆◆	◆◆◆

Quick finder Solid Carbide End Mills

Schnellsuche VHM Fräser





































P

Slot milling Vollnutfräsen	Peripheral milling Umfangfräsen	Roughing Schruppen	Trochoidal Trochoidal	Ramp milling Rampen-Fräsen	Drilling Bohren	3D Milling 3D-Fräsen	Chapter Kapitel	Page Seite
●	●	-	●	●	-	-	V	4 - 5
●	●	-	●	●	-	-	V	6 - 7
●	●	-	●	●	-	●	V	8 - 9
●	●	-	●	●	●	-	V	12 - 13
●	●	-	●	●	-	-	VI	12 - 13
●	●	-	-	●	-	-	VI	14 - 15
●	●	-	-	●	-	●	VI	16 - 17
-	-	-	●	-	-	-	V	16 - 17
-	-	-	●	-	-	○	V	18 - 19
-	●	-	-	-	-	-	IV	30 - 31
-	●	-	-	-	-	-	IV	32 - 33
-	●	-	-	-	-	-	IV	34 - 35
-	●	-	-	-	-	-	V	28 - 29
-	●	-	-	-	-	-	VI	18 - 19
-	●	-	-	-	-	-	VI	20 - 21
-	●	-	-	-	-	●	VI	22 - 23
●	●	●	-	-	-	-	IV	38 - 39
-	●	●	-	-	-	-	IV	40 - 41
●	●	●	-	-	-	-	IV	42 - 43
●	●	●	-	-	-	-	V	24 - 25

Quick finder Solid Carbide End Mills

Schnellsuche VHM Fräser

P

	Product code Artikelnummer	z	Helix / rake angle Spirale / Spanwinkel	Diameter range Durchmesserbereich	End face geometry Stirrfächengeometrie	P1	P2	P3
	BLC4L45RN	3/4/5/6		4,0 - 20,0		◆◆◆	◆◆◆	◆◆◆
	BLC2S30B	2		3,0 - 20,0		◆◆◆	◆◆	◆◆
	BLC2L30B	2		3,0 - 20,0		◆◆◆	◆◆	◆◆
	PLSC2X30B	2		2,0 - 20,0		◆◆	◆◆◆	◆◆◆
	PLSC4X30B	4		2,0 - 20,0		◆◆	◆◆◆	◆◆◆
	BLC4LA90	4		6,0 - 12,0		◆◆◆	◆◆	◆◆
	BLC4LA60	4		6,0 - 12,0		◆◆◆	◆◆	◆◆
	BLC4L...C...	4		6,0 - 14,0		◆◆◆	◆◆	◆◆
	ULC2S30T...	2		0,2 - 2,0		◆◆◆	◆◆◆	◆◆◆
	ULC2S30N...T...	2		0,2 - 2,0		◆◆◆	◆◆◆	◆◆◆
	ULC2S30B	2		0,2 - 2,0		◆◆◆	◆◆◆	◆◆◆
	ULC2S...30N...B	2		0,2 - 2,0		◆◆◆	◆◆◆	◆◆◆

MICRO

MICRO

Quick finder Solid Carbide End Mills











































Schnellsuche VHM Fräser

Slot milling Vollnutfräsen	Peripheral milling Umfangfräsen	Roughing Schruppen	Trochoidal Trochoidal	Ramp milling Rampen-Fräsen	Drilling Bohren	3D Milling 3D-Fräsen	Chapter Kapitel	Page Seite
●	●	●	-	-	-	-	V	26 - 27
-	-	-	-	-	-	●	IV	44 - 45
-	-	-	-	-	-	●	IV	46 - 47
-	-	-	-	-	-	●	VI	24 - 25
-	-	-	-	-	-	●	VI	26 - 27
-	●	-	-	-	-	-	IV	48 - 49
-	●	-	-	-	-	-	IV	50 - 51
-	●	-	-	-	-	-	IV	52 - 53
●	-	-	-	-	-	●	VII	22 - 23
●	-	-	-	-	-	●	VII	24 - 25
-	-	-	-	-	-	●	VII	26 - 27
-	-	-	-	-	-	●	VII	28 - 29

Quick finder Solid Carbide End Mills

Schnellsuche VHM Fräser

K

	Product code Artikelnummer	z	Helix / rake angle Spirale / Spanwinkel	Diameter range Durchmesserbereich	End face geometry Stirrfächengeometrie	K1	K2
	FLC2L30S	2		3,0 - 20,0		◆◆	◆
	FLC2L30SC	2		3,0 - 20,0		◆◆◆	◆◆
	BLC2S30S	2		3,0 - 20,0		◆◆◆	◆◆
	BLC2L30S	2		3,0 - 20,0		◆◆◆	◆◆
	PLSC2X30S	2		2,0 - 20,0		◆◆◆	◆◆◆
	PLSC2X30T..	2		4,0 - 16,0		◆◆◆	◆◆◆
	FLC3S30S	3		0,5 - 12,0		◆◆	◆
	FLC3S30SC	3		0,5 - 12,0		◆◆◆	◆◆
	FLC3L30S	3		3,0 - 20,0		◆◆	◆
	FLC3L30SC	3		3,0 - 20,0		◆◆◆	◆◆
	BLC3S30S	3		3,0 - 20,0		◆◆◆	◆◆
	BLC3L30S	3		3,0 - 20,0		◆◆◆	◆◆
	BLC3S45S	3		3,0 - 20,0		◆◆◆	◆◆
	BLC3L45S	3		3,0 - 20,0		◆◆◆	◆◆
	PLSC3S38V	3		3,0 - 20,0		◆◆◆	◆◆◆
	PLSC3L38V	3		3,0 - 20,0		◆◆◆	◆◆◆
	FLC4L30S	4		3,0 - 20,0		◆◆	◆
	FLC4L30SC	4		3,0 - 20,0		◆◆◆	◆◆
	BLC4S30S	4		3,0 - 20,0		◆◆◆	◆◆
	BLC4L30S	4		3,0 - 20,0		◆◆◆	◆◆
	BLC4L38V	4		3,0 - 20,0		◆◆◆	◆◆

Quick finder Solid Carbide End Mills





Schnellsuche VHM Fräser

Slot milling Vollnutfräsen	Peripheral milling Umfangfräsen	Roughing Schruppen	Trochoidal Trochoidal	Ramp milling Rampen-Fräsen	Drilling Bohren	3D Milling 3D-Fräsen	Chapter Kapitel	Page Seite
○	●	-	-	-	-	-	III	4 - 5
○	●	-	-	-	-	-	III	6 - 7
○	●	-	-	-	-	-	IV	14 - 15
○	●	-	-	-	-	-	IV	16 - 17
○	●	-	-	-	-	-	VI	4 - 5
○	●	-	-	-	-	●	VI	6 - 7
○	●	-	-	-	-	-	III	8 - 9
○	●	-	-	-	-	-	III	10 - 11
○	●	-	-	-	-	-	III	12 - 13
○	●	-	-	-	-	-	III	14 - 15
○	●	-	-	-	-	-	IV	18 - 19
○	●	-	-	-	-	-	IV	20 - 21
○	●	-	-	-	-	-	IV	22 - 23
○	●	-	-	-	-	-	IV	24 - 25
○	●	-	-	-	-	-	VI	8 - 9
○	●	-	-	-	-	-	VI	10 - 11
-	●	-	-	-	-	-	III	16 - 17
-	●	-	-	-	-	-	III	18 - 19
-	●	-	-	-	-	-	IV	26 - 27
-	●	-	-	-	-	-	IV	28 - 29
○	●	-	●	●	-	-	IV	36 - 37

Quick finder Solid Carbide End Mills

Schnellsuche VHM Fräser

K

	Product code Artikelnummer	z	Helix / rake angle Spirale / Spanwinkel	Diameter range Durchmesserbereich	End face geometry Stirrfächengeometrie	K1	K2
	BLC4S38VN	4		3,0 - 20,0		◆◆◆	◆◆◆
	BLC4L38VN	4		3,0 - 20,0		◆◆◆	◆◆◆
	BLC4L38VNT	4		6,0 - 16,0		◆◆◆	◆◆◆
	BLC4L38VND	4		5,7 - 20,0		◆◆◆	◆◆◆
	PLSC4L45V	4		3,0 - 25,0		◆◆◆	◆◆◆
	PLSC4L55S	4		4,0 - 20,0		◆◆◆	◆◆◆
	PLSC4X45T..	4		4,0 - 16,0		◆◆◆	◆◆◆
	BLC5L38VN	5		6,0 - 25,0		◆◆◆	◆◆◆
	BLC5L38VNT	5		6,0 - 20,0		◆◆◆	◆◆◆
	BLC6L45S	6/8		6,0 - 20,0		◆◆◆	◆◆
	BLC6X45S	6/8		6,0 - 20,0		◆◆◆	◆◆
	BLC6X45X	6/8		6,0 - 20,0		◆◆◆	◆◆
	BLC6L45SN	6/8		6,0 - 20,0		—	◆◆◆
	PLSC6L50S	6/8		6,0 - 25,0		◆◆◆	◆◆◆
	PLSC6X50S	6/8		6,0 - 25,0		◆◆◆	◆◆◆
	PLSC6X50T..	6/8		6,0 - 20,0		◆◆◆	◆◆◆
	BLC4L45U	4		4,0 - 20,0		◆◆◆	◆◆
	BLC4L20R	3/4		6,0 - 20,0		◆◆◆	◆◆
	BLC4L45R	3/4/5/6		4,0 - 20,0		◆◆◆	◆◆
	BLC4S45RN	3/4/5/6		4,0 - 20,0		◆◆◆	◆◆◆

Quick finder Solid Carbide End Mills

























Schnellsuche VHM Fräser

Slot milling Vollnutfräsen	Peripheral milling Umfangfräsen	Roughing Schruppen	Trochoidal Trochoidal	Ramp milling Ramper-Fräsen	Drilling Bohren	3D Milling 3D-Fräsen	Chapter Kapitel	Page Seite
○	●	-	●	●	-	-	V	4 - 5
○	●	-	●	●	-	-	V	6 - 7
○	●	-	●	●	-	●	V	8 - 9
○	●	-	●	●	●	-	V	12 - 13
○	●	-	●	●	-	-	VI	12 - 13
○	●	-	-	●	-	-	VI	14 - 15
○	●	-	-	-	-	●	VI	16 - 17
-	●	-	●	-	-	-	V	16 - 17
-	●	-	●	-	-	●	V	18 - 19
-	●	-	-	-	-	-	IV	30 - 31
-	●	-	-	-	-	-	IV	32 - 33
-	●	-	-	-	-	-	IV	34 - 35
-	●	-	-	-	-	-	V	28 - 29
-	●	-	-	-	-	-	VI	18 - 19
-	●	-	-	-	-	-	VI	20 - 21
-	●	-	-	-	-	●	VI	22 - 23
○	●	●	-	-	-	-	IV	38 - 39
○	●	●	-	-	-	-	IV	40 - 41
○	●	●	-	-	-	-	IV	42 - 43
○	●	●	-	-	-	-	V	24 - 25

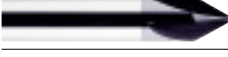
Quick finder Solid Carbide End Mills

Schnellsuche VHM Fräser

K

	Product code Artikelnummer	z	Helix / rake angle Spirale / Spanwinkel	Diameter range Durchmesserbereich	End face geometry Stirrfächengeometrie	K1	K2
	BLC4L45RN	3/4/5/6		4,0 - 20,0		◆◆◆	◆◆◆
	BLC2S30B	2		3,0 - 20,0		◆◆◆	◆◆
	BLC2L30B	2		3,0 - 20,0		◆◆◆	◆◆
	PLSC2X30B	2		2,0 - 20,0		◆◆◆	◆◆◆
	PLSC4X30B	4		2,0 - 20,0		◆◆◆	◆◆◆
	BLC4LA90	4		6,0 - 12,0		◆◆◆	◆◆
	BLC4LA60	4		6,0 - 12,0		◆◆◆	◆◆
	BLC4L...C...	4		6,0 - 14,0		◆◆◆	◆◆

Quick finder Solid Carbide End Mills

























Schnellsuche VHM Fräser

Slot milling Vollnutfräsen	Peripheral milling Umfangfräsen	Roughing Schruppen	Trochoidal Trochoidal	Ramp milling Rampen-Fräsen	Drilling Bohren	3D Milling 3D-Fräsen	Chapter Kapitel	Page Seite
○	●	●	-	-	-	-	V	26 - 27
-	-	-	-	-	-	●	IV	44 - 45
-	-	-	-	-	-	●	IV	46 - 47
-	-	-	-	-	-	●	VI	24 - 25
-	-	-	-	-	-	●	VI	26 - 27
-	●	-	-	-	-	-	IV	48 - 49
-	●	-	-	-	-	-	IV	50 - 51
-	●	-	-	-	-	-	IV	52 - 53

Quick finder Solid Carbide End Mills

Schnellsuche VHM Fräser

M
S

	Product code Artikelnummer	z	Helix / rake angle Spirale / Spanwinkel	Diameter range Durchmesserbereich	End face geometry Stirrfächengeometrie	M1	M2	S1
	PLIC3L55V	3		3,0 - 20,0		◆◆◆	◆◆◆	◆◆◆
	BLC4L42VN	4		3,0 - 20,0		◆◆◆	◆◆	◆◆
	BLC4L42VNT..	4		6,0 - 16,0		◆◆◆	◆◆	◆◆
	PLIC4L55S	4		6,0 - 20,0		◆◆◆	◆◆◆	◆◆◆
	PLIC4X55S	4		6,0 - 20,0		◆◆◆	◆◆◆	◆◆◆
	BLC5L42VN	5		6,0 - 25,0		◆◆◆	◆◆◆	◆◆
	BLC5L42VNT	5		6,0 - 20,0		◆◆◆	◆◆◆	◆◆
	PLIC3L35R	3		6,0 - 20,0		◆◆	◆◆	◆◆◆

Quick finder Solid Carbide End Mills

Schnellsuche VHM Fräser

S2	Slot milling Vollnutfräsen	Peripheral milling Umfangfräsen	Roughing Schruppen	Trochoidal Trochoidal	Ramp milling Rampen-Fräsen	Drilling Bohren	3D Milling 3D-Fräsen	Chapter Kapitel	Page Seite
◆◆◆	●	●	-	-	-	-	-	VI	28 - 29
◆◆◆	●	●	-	-	○	-	-	V	30 - 31
◆◆◆	●	●	-	-	○	-	●	V	32 - 33
◆◆◆	●	●	-	-	○	-	-	VI	30 - 31
◆◆◆	●	●	-	-	○	-	-	VI	32 - 33
◆◆◆	-	-	-	●	-	-	-	V	20 - 21
◆◆◆	-	-	-	●	-	-	●	V	22 - 23
◆◆◆	●	●	●	-	-	-	-	VI	34 - 35

Quick finder Solid Carbide End Mills

Schnellsuche VHM Fräser

N

	Product code Artikelnummer	z	Helix / rake angle Spirale / Spanwinkel	Diameter range Durchmesserbereich	End face geometry Stirrfächengeometrie	N1	N2
	BLC1S30S	1		3,0 - 12,0		◆◆	◆◆
	BLC2L45S	2		3,0 - 20,0		◆◆	◆◆
	BLC3L45A	3		3,0 - 20,0		◆◆	◆◆
	PLAC3L45V	3		6,0 - 25,0		◆◆◆	◆◆◆
	PLAC3X45V	3		6,0 - 25,0		◆◆◆	◆◆◆
	BLC4L38S	4		4,0 - 20,0		◆◆	◆◆
	BLC3L25R	3		6,0 - 20,0		◆◆	◆◆
	PLAC3L35R	3		6,0 - 25,0		◆◆◆	◆◆◆
	PLAC3L25RF	3/4		4,0 - 20,0		◆◆◆	◆◆◆
	PLAC3X45B	3		6,0 - 25,0		◆◆◆	◆◆◆

Quick finder Solid Carbide End Mills

Schnellsuche VHM Fräser

Slot milling Vollnutfräsen	Peripheral milling Umfangfräsen	Roughing Schruppen	Trochoidal Trochoidal	Ramp milling Rampen-Fräsen	Drilling Bohren	3D Milling 3D-Fräsen	Chapter Kapitel	Page Seite
●	●	-	-	-	●	-	IV	4 - 5
●	●	-	-	-	○	-	IV	6 - 7
●	●	-	-	-	○	-	IV	8 - 9
●	●	-	-	-	○	-	VI	36 - 37
●	●	-	-	-	○	-	VI	38 - 39
●	●	-	-	-	-	-	IV	10 - 11
●	●	●	-	-	-	-	IV	12 - 13
●	●	●	-	-	-	-	VI	40 - 41
●	●	●	-	-	-	-	VI	42 - 43
-	-	-	-	-	-	●	VI	44 - 45

N

Quick finder Solid Carbide End Mills

Schnellsuche VHM Fräser

H

	Product code Artikelnummer	z	Helix / rake angle Spirale / Spanwinkel	Diameter range Durchmesserbereich	End face geometry Stirrfächengeometrie	H1	H2	H3
	UL4S30SNT	4		3,0 - 12,0		◆◆	◆◆◆	◆◆◆
	UL4X30SNT	4		3,0 - 12,0		◆◆	◆◆◆	◆◆◆
	ULC4S10SNT...	4		3,0 - 12,0		◆	◆◆	◆◆◆
	ULC4X10SNT...	4		3,0 - 12,0		◆	◆◆	◆◆◆
	BLC6L45SN	6/8		6,0 - 20,0		◆◆◆	◆◆◆	◆◆
	ULC6L50SNT..	6/8/10		3,0 - 20,0		◆	◆◆	◆◆◆
	ULC6X50S	6/8/10		6,0 - 20,0		◆	◆◆	◆◆◆
	ULC6X50SNT..	6/8/10		6,0 - 20,0		◆	◆◆	◆◆◆
	ULC2S15B	2		3,0 - 12,0		◆	◆◆	◆◆◆
	ULC2X15B	2		3,0 - 12,0		◆	◆◆	◆◆◆
	ULC2S30T...	2		0,2 - 2,0		◆◆◆	◆◆◆	◆◆◆
	ULC2S30N...T...	2		0,2 - 2,0		◆◆◆	◆◆◆	◆◆◆
	ULC2S30B	2		0,2 - 2,0		◆◆◆	◆◆◆	◆◆◆
	ULC2S...30N...B	2		0,2 - 2,0		◆◆◆	◆◆◆	◆◆◆

MICRO

MICRO

Quick finder Solid Carbide End Mills

Schnellsuche VHM Fräser

Slot milling Vollnutfräsen	Peripheral milling Umfangfräsen	Roughing Schruppen	Trochoidal Trochoidal	Ramp milling Ramper-Fräsen	Drilling Bohren	3D Milling 3D-Fräsen	Chapter Kapitel	Page Seite
●	●	-	●	●	-	●	VII	4 - 5
●	●	-	●	●	-	●	VII	6 - 7
●	-	●	-	●	-	●	VII	8 - 9
●	-	●	-	●	-	●	VII	10 - 11
-	●	-	-	-	-	-	V	28 - 29
-	●	-	-	-	-	●	VII	12 - 13
-	●	-	-	-	-	-	VII	14 - 15
-	●	-	-	-	-	●	VII	16 - 17
-	-	-	-	-	-	●	VII	18 - 19
-	-	-	-	-	-	●	VII	20 - 21
●	-	-	-	-	-	●	VII	22 - 23
●	-	-	-	-	-	●	VII	24 - 25
-	-	-	-	-	-	●	VII	26 - 27
-	-	-	-	-	-	●	VII	28 - 29

UK

▶ Quick finder Solid Carbide Drills

D

▶ Schnellsuche VHM Bohrer

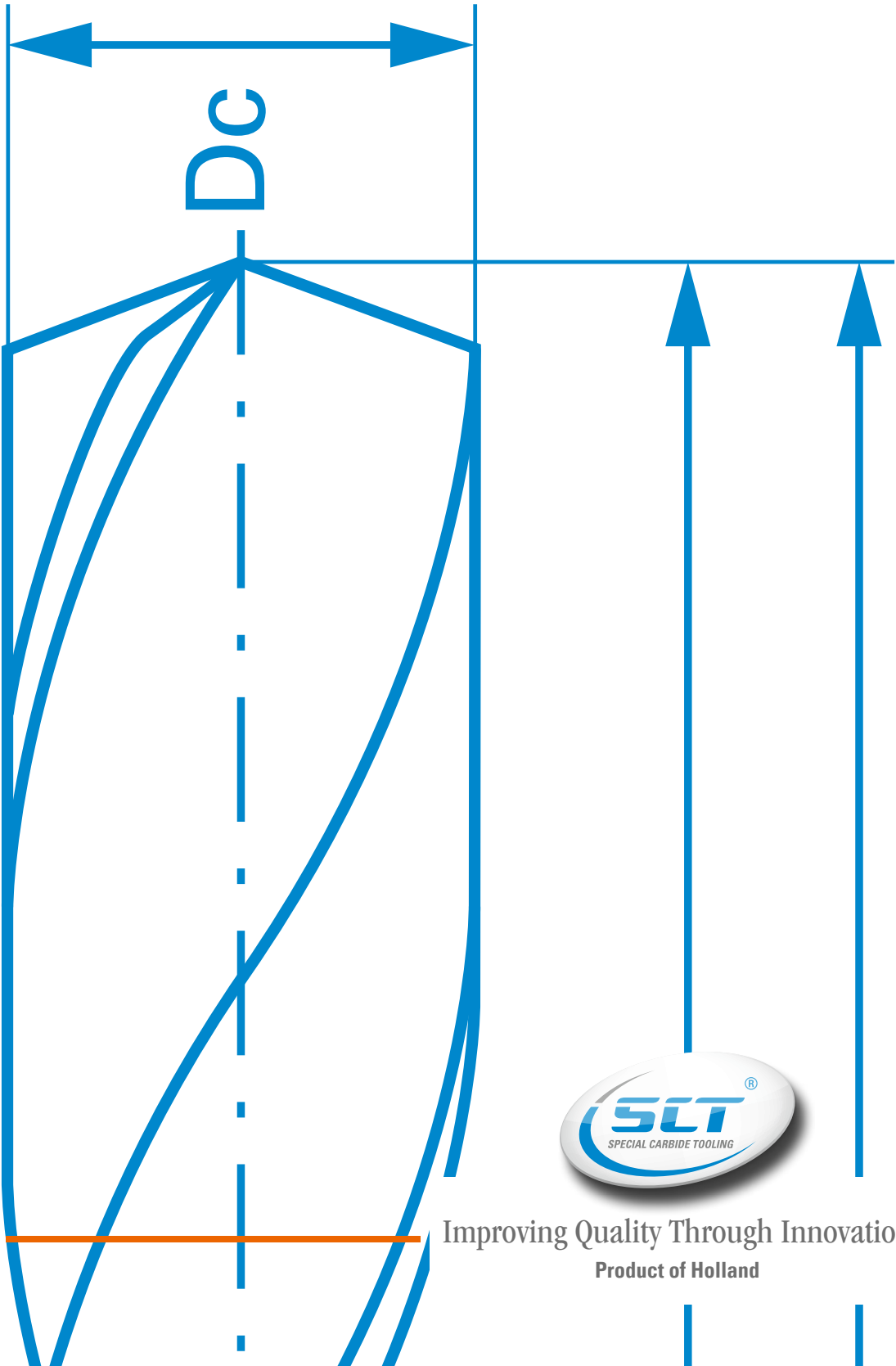

Improving Quality Through Innovation

Product of Holland

Product code description

Artikelnummer Beschreibung

Drills / Bohrer

BASIC LINE



EXAMPLE/
BEISPIEL:

BLD E 2 08D 0360 30 S IK

BLD Product line - Basic Line drills / Produktlinie - Basic Line Bohrer

E E = Whistle notch shank / Whistle-Notch Spannfläche

2 Number of flutes / Zähnezahl

08D Maximum drill depth 8xD / Maximale Bohrtiefe 8xD

0360 Cutting diameter $\varnothing 3,6$ / Schneidendurchmesser $\varnothing 3,6$

30 Helix angle / Drallwinkel



















S Standard flute / Schlichten

IK Internal coolant / Innenkühlung

Quick finder Solid Carbide Drills

Schnellsuche VHM Bohrer

P

	Product code Artikelnummer	z	Point angle Spitzenwinkel	Diameter range Durchmesserbereich	Drill depth Bohrtiefe
	FLDC2S30S	2	120° 	1,5 - 12,0	Short/Kurze
	FLDC2L30S	2	120° 	2,0 - 12,0	Long/Lange
	BLDC203D30S	2	140° 	3,0 - 20,0	3xD
	BLDC203D30SIK	2	140° 	3,0 - 20,0	3xD
	BLDC205D30SIK	2	140° 	3,0 - 20,0	5xD
	BLDC208D30SIK	2	140° 	3,0 - 20,0	8xD
	BLDC212D30SIK	2	140° 	3,0 - 20,0	12xD
	FLDC2SA90	2	90° 	6,0 - 12,0	–
	FLDC2SA120	2	120° 	6,0 - 12,0	–

Quick finder Solid Carbide Drills









Schnellsuche VHM Bohrer

Internal coolant Innerkühlung	P1	P2	P3	Chapter Kapitel	Page Seite
-	◆◆	◆◆	-	IX	4 - 7
-	◆◆	◆◆	-	IX	8 - 11
-	◆◆◆	◆◆◆	◆◆	X	4 - 9
●	◆◆◆	◆◆◆	◆◆	X	10 - 15
●	◆◆◆	◆◆◆	◆◆	X	16 - 21
●	◆◆◆	◆◆◆	◆◆	X	22 - 27
●	◆◆◆	◆◆◆	◆◆	X	28 - 33
-	◆◆	◆◆	-	IX	12 - 13
-	◆◆	◆◆	-	IX	14 - 15

Quick finder Solid Carbide Drills

Schnellsuche VHM Bohrer

K

	Product code Artikelnummer	z	Point angle Spitzenwinkel	Diameter range Durchmesserbereich	Drill depth Bohrtiefe
	FLDC2S30S	2	120°	1,5 - 12,0	Short/Kurze
	FLDC2L30S	2	120°	2,0 - 12,0	Long/Lange
	BLDC203D30S	2	140°	3,0 - 20,0	3xD
	BLDC203D30SIK	2	140°	3,0 - 20,0	3xD
	BLDC205D30SIK	2	140°	3,0 - 20,0	5xD
	BLDC208D30SIK	2	140°	3,0 - 20,0	8xD
	BLDC212D30SIK	2	140°	3,0 - 20,0	12xD
	FLDC2SA90	2	90°	6,0 - 12,0	–
	FLDC2SA120	2	120°	6,0 - 12,0	–

Quick finder Solid Carbide Drills

Schnellsuche VHM Bohrer











K

Internal coolant Innerkühlung	K1	K2	Chapter Kapitel	Page Seite
–	◆◆	◆◆	IX	4 - 7
–	◆◆	◆◆	IX	8 - 11
–	◆◆◆	◆◆◆	X	4 - 9
●	◆◆◆	◆◆◆	X	10 - 15
●	◆◆◆	◆◆◆	X	16 - 21
●	◆◆◆	◆◆◆	X	22 - 27
●	◆◆◆	◆◆◆	X	28 - 33
–	◆◆	◆◆	IX	12 - 13
–	◆◆	◆◆	IX	14 - 15

Quick finder Solid Carbide Drills

Schnellsuche VHM Bohrer

 M
S

	Product code Artikelnummer	z	Point angle Spitzenwinkel	Diameter range Durchmesserbereich	Drill depth Bohrtiefe
	FLDC2S30S	2	120°	1,5 - 12,0	Short/Kurze
	FLDC2L30S	2	120°	2,0 - 12,0	Long/Lange
	BLDC203D30S	2	140°	3,0 - 20,0	3xD
	BLDC203D30SIK	2	140°	3,0 - 20,0	3xD
	PLDIC203D30IK	2	140°	3,0 - 20,0	3xD
	BLDC205D30SIK	2	140°	3,0 - 20,0	5xD
	PLDIC205D30IK	2	140°	3,0 - 20,0	5xD
	BLDC208D30SIK	2	140°	3,0 - 20,0	8xD
	BLDC212D30SIK	2	140°	3,0 - 20,0	12xD
	FLDC2SA90	2	90°	6,0 - 12,0	–
	FLDC2SA120	2	120°	6,0 - 12,0	–

Quick finder Solid Carbide Drills





Schnellsuche VHM Bohrer

Internal coolant Innerkühlung	M1	M2	S2	S2	Chapter Kapitel	Page Seite
–	◇	◇	◇	◇	IX	4 - 7
–	◇	◇	◇	◇	IX	8 - 11
–	◇◇	◇◇	◇◇	◇◇	X	4 - 9
●	◇◇	◇◇	◇◇	◇◇	X	10 - 15
●	◆◆◆	◆◆◆	◆◆◆	◆◆◆	XI	4 - 9
●	◇◇	◇◇	◇◇	◇◇	X	16 - 21
●	◆◆◆	◆◆◆	◆◆◆	◆◆◆	XI	10 - 15
●	◇◇	◇◇	◇◇	◇◇	X	22 - 27
●	◇◇	◇◇	◇◇	–	X	28 - 33
–	◇	◇	◇	◇	IX	12 - 13
–	◇	◇	◇	◇	IX	14 - 15

Quick finder Solid Carbide Drills

Schnellsuche VHM Bohrer

N

	Product code Artikelnummer	z	Point angle Spitzenwinkel	Diameter range Durchmesserbereich	Drill depth Bohrtiefe
	FLDC2S30S	2	120° ↓	1,5 - 12,0	Short/Kurze
	FLDC2L30S	2	120° ↓	2,0 - 12,0	Long/Lange
	FLDC2SA90	2	90° ↓	6,0 - 12,0	–
	FLDC2SA120	2	120° ↓	6,0 - 12,0	–

Quick finder Solid Carbide Drills

Schnellsuche VHM Bohrer





N

Internal coolant Innerkühlung	N1	N2	Chapter Kapitel	Page Seite
–	◆◆	◆◆	IX	4 - 7
–	◆◆	◆◆	IX	8 - 11
–	◆◆	◆◆	IX	12 - 13
–	◆◆	◆◆	IX	14 - 15

Quick finder Solid Carbide Drills

Schnellsuche VHM Bohrer

H

	Product code Artikelnummer	z	Point angle Spitzenwinkel	Diameter range Durchmesserbereich	Drill depth Bohrtiefe
	BLDC203D30S	2	140° ↓	3,0 - 20,0	3xD
	BLDC203D30SIK	2	140° ↓	3,0 - 20,0	3xD
	BLDC205D30SIK	2	140° ↓	3,0 - 20,0	5xD
	BLDC208D30SIK	2	140° ↓	3,0 - 20,0	8xD
	BLDC212D30SIK	2	140° ↓	3,0 - 20,0	12xD

Quick finder Solid Carbide Drills

Schnellsuche VHM Bohrer

Internal coolant Innerkühlung	H1	H2	H3	Chapter Kapitel	Page Seite
–	◆	◆	–	⊗	4 - 9
●	◆	◆	–	⊗	10 - 15
●	◆	◆	–	⊗	16 - 21
●	◆	◆	–	⊗	22 - 27
●	◆	◆	–	⊗	28 - 33

UK D











- ▶ Cost efficient tools / Kosten effiziente Werkzeuge
- ▶ Standard geometry / Standard Geometrie
- ▶ Soft steels (<45 HRC) / Weiche Stähle (<45 HRC)
- ▶ Uncoated / Unbeschichtet
- ▶ TiCN coated / TiCN beschichtet



Improving Quality Through Innovation

Product of Holland

Table of contents Inhaltsverzeichnis

2 flute end mill; 30° helix; SCT norm; long length; uncoated Schaftfräser 2 Schneiden; 30° Drallwinkel; SCT Norm; lange Ausführung; unbeschichtet	4 - 5	
2 flute end mill; 30° helix; SCT norm; long length; TiCN coated Schaftfräser 2 Schneiden; 30° Drallwinkel; SCT Norm; lange Ausführung; TiCN beschichtet	6 - 7	
3 flute end mill; 30° helix; SCT norm; stub length; uncoated Schaftfräser 3 Schneiden; 30° Drallwinkel; SCT Norm; extra kurze Ausführung; unbeschichtet	8 - 9	
3 flute end mill; 30° helix; SCT norm; stub length; TiCN coated Schaftfräser 3 Schneiden; 30° Drallwinkel; SCT Norm; extra kurze Ausführung; TiCN beschichtet	10 - 11	
3 flute end mill; 30° helix; SCT norm; long length; uncoated Schaftfräser 3 Schneiden; 30° Drallwinkel; SCT Norm; lange Ausführung; unbeschichtet	12 - 13	
3 flute end mill; 30° helix; SCT norm; long length; TiCN coated Schaftfräser 3 Schneiden; 30° Drallwinkel; SCT Norm; lange Ausführung; TiCN beschichtet	14 - 15	
4 flute end mill; 30° helix; SCT norm; long length; uncoated Schaftfräser 4 Schneiden; 30° Drallwinkel; SCT Norm; lange Ausführung; unbeschichtet	16 - 17	
4 flute end mill; 30° helix; SCT norm; long length; TiCN coated Schaftfräser 4 Schneiden; 30° Drallwinkel; SCT Norm; lange Ausführung; TiCN beschichtet	18 - 19	

2 flute end mill; 30° helix; SCT norm; long length; uncoated
 Schaftfräser 2 Schneiden; 30° Drallwinkel; SCT Norm; lange Ausführung; unbeschichtet

Specifications / Spezifikationen



DIN 6535 HA	DIN 6535 HB	Dc	Ds	Lc	Ln	Dn	Lt	r	z
FLC2L03030S	-	3,0	3	12	-	-	40	-	2
FLC2L04030S	-	4,0	4	12	-	-	40	-	2
FLC2L05030S	-	5,0	5	14	-	-	50	-	2
FLC2L06030S	-	6,0	6	16	-	-	50	-	2
FLC2L08030S	-	8,0	8	20	-	-	60	-	2
FLC2L10030S	-	10,0	10	22	-	-	70	-	2
FLC2L12030S	-	12,0	12	22	-	-	70	-	2
FLC2L16030S	-	16,0	16	25	-	-	75	-	2
FLC2L20030S	-	20,0	20	32	-	-	100	-	2



2 flute end mill; 30° helix; SCT norm; long length; TiCN coated
 Schafffräser 2 Schneiden; 30° Drallwinkel; SCT Norm; lange Ausführung; TiCN beschichtet

Specifications / Spezifikationen



DIN 6535 HA	DIN 6535 HB	Dc	Ds	Lc	Ln	Dn	Lt	r	z
FLC2L03030SC	-	3,0	3	12	-	-	40	-	2
FLC2L04030SC	-	4,0	4	12	-	-	40	-	2
FLC2L05030SC	-	5,0	5	14	-	-	50	-	2
FLC2L06030SC	-	6,0	6	16	-	-	50	-	2
FLC2L08030SC	-	8,0	8	20	-	-	60	-	2
FLC2L10030SC	-	10,0	10	22	-	-	70	-	2
FLC2L12030SC	-	12,0	12	22	-	-	70	-	2
FLC2L16030SC	-	16,0	16	25	-	-	75	-	2
FLC2L20030SC	-	20,0	20	32	-	-	100	-	2



3 flute end mill; 30° helix; SCT norm; stub length; uncoated

Schaftfräser 3 Schneiden; 30° Drallwinkel; SCT Norm; extra kurze Ausführung; unbeschichtet

Workpiece material groups and cutting speed / Werkstoffgruppen und Schnittgeschwindigkeiten

Material Material	Tensile strength Zugfestigkeit Rm [N/mm ²]	Hardness Härte [HB/HRC]	Cutting speed Vc [m/min] Schnittgeschwindigkeiten		
			min	opt	max
P1 Plain carbon steel / Unlegierter Stahl	< 600	< 230	100	140	175
P2 Alloy Steel / Legierter Stahl	< 1200	< 350	55	85	130
P3 High alloy steel and tool steel / Hochlegierter Stahl und Werkzeugstahl	< 1400	< 380	45	65	85
M1 Aust. and Ferr. Stainless steel / Aust. und Ferr. rostfreie Stähle	< 680	< 220	60	70	100
M2 Mart. Stainless steel / Mart. rostfreie Stähle	< 820	< 240	45	60	85
K1 Grey cast iron / Grauguß	-	< 280	85	105	130
K2 Ductile cast iron / Sphäroguß	-	< 320	70	85	100
N1 Non-ferrous alloys / Nichteisenmetalle	< 250	< 110	-	-	-
N2 Aluminium alloys / Aluminiumlegierungen	< 530	< 130	-	-	-
S1 High temperature alloys Fe, Ni and Co based / Warmfeste Leg. Fe, Ni und Co	< 3300	< 350	30	45	55
S2 Titanium alloys; Alpha and Beta / Titan Legierungen Alpha und Beta	< 2100	< 400	45	55	65
H1 Hardened steel / Gehärtete Stähle	-	< 54 HRC	-	-	-
H2 Hardened steel / Gehärtete Stähle	-	52-60 HRC	-	-	-
H3 Hardened steel / Gehärtete Stähle	-	> 58 HRC	-	-	-
G1 Graphite / Graphit	-	-	-	-	-

Cutting conditions / Zerspanungswerte

Peripheral milling / Umfangfräsen



Dc	Ap [0.5xD]	Ae 1 [0.2xD]	Ae 2	fz 1 ▼▼	fz 2 ▼
0,5	0,25	0,10	-	0,002	0,003
0,6	0,30	0,12	-	0,002	0,003
0,8	0,40	0,16	-	0,003	0,005
1,0	0,50	0,20	-	0,004	0,006
1,2	0,60	0,24	-	0,004	0,007
1,5	0,75	0,30	-	0,005	0,009
1,8	0,90	0,36	-	0,006	0,010
2,0	1,00	0,40	-	0,007	0,012
2,5	1,25	0,50	-	0,009	0,015
3,0	1,50	0,60	-	0,011	0,017
3,5	1,75	0,70	-	0,012	0,020
4,0	2,00	0,80	-	0,014	0,023
4,5	2,25	0,90	-	0,016	0,026
5,0	2,50	1,00	-	0,018	0,029
5,5	2,75	1,10	-	0,019	0,032
5,8	2,90	1,16	-	0,020	0,034
6,0	3,00	1,20	-	0,021	0,035
6,8	3,40	1,36	-	0,024	0,040
7,0	3,50	1,40	-	0,025	0,041
7,8	3,90	1,56	-	0,027	0,045
8,0	4,00	1,60	-	0,028	0,047
8,7	4,35	1,74	-	0,030	0,051
9,0	4,50	1,80	-	0,032	0,052
9,7	4,85	1,94	-	0,034	0,057
10,0	5,00	2,00	-	0,035	0,058
12,0	6,00	2,40	-	0,042	0,070

Slot milling / Vollnutfräsen



Dc	Ap [0.2xD]	Ae [1xD]	fz
0,5	0,10	0,50	0,001
0,6	0,12	0,60	0,001
0,8	0,16	0,80	0,002
1,0	0,20	1,00	0,002
1,2	0,24	1,20	0,003
1,5	0,30	1,50	0,004
1,8	0,36	1,80	0,004
2,0	0,40	2,00	0,005
2,5	0,50	2,50	0,006
3,0	0,60	3,00	0,007
3,5	0,70	3,50	0,008
4,0	0,80	4,00	0,009
4,5	0,90	4,50	0,011
5,0	1,00	5,00	0,012
5,5	1,10	5,50	0,013
5,8	1,16	5,80	0,014
6,0	1,20	6,00	0,014
6,8	1,36	6,80	0,016
7,0	1,40	7,00	0,016
7,8	1,56	7,80	0,018
8,0	1,60	8,00	0,019
8,7	1,74	8,70	0,020
9,0	1,80	9,00	0,021
9,7	1,94	9,70	0,023
10,0	2,00	10,00	0,023
12,0	2,40	12,00	0,028

3 flute end mill; 30° helix; SCT norm; stub length; uncoated
 Schafffräser 3 Schneiden; 30° Drallwinkel; SCT Norm; extra kurze Ausführung; unbeschichtet

Specifications / Spezifikationen



DIN 6535 HA	DIN 6535 HB	Dc	Ds	Lc	Ln	Dn	Lt	r	z
FLC3S00530S	-	0,5	3	1,5	-	-	40	-	3
FLC3S00630S	-	0,6	3	1,5	-	-	40	-	3
FLC3S00830S	-	0,8	3	2	-	-	40	-	3
FLC3S01030S	-	1,0	3	2	-	-	40	-	3
FLC3S01230S	-	1,2	3	2	-	-	40	-	3
FLC3S01530S	-	1,5	3	2	-	-	40	-	3
FLC3S01830S	-	1,8	3	2	-	-	40	-	3
FLC3S02030S	-	2,0	6	4	-	-	40	-	3
FLC3S02530S	-	2,5	6	5	-	-	40	-	3
FLC3S03030S	-	3,0	6	5	-	-	40	-	3
FLC3S03530S	-	3,5	6	6	-	-	40	-	3
FLC3S04030S	-	4,0	6	7	-	-	40	-	3
FLC3S04530S	-	4,5	6	8	-	-	40	-	3
FLC3S05030S	-	5,0	6	8	-	-	40	-	3
FLC3S05530S	-	5,5	6	8	-	-	40	-	3
FLC3S05830S	-	5,8	6	8	-	-	40	-	3
FLC3S06030S	-	6,0	6	8	-	-	40	-	3
FLC3S06830S	-	6,8	8	10	-	-	45	-	3
FLC3S07030S	-	7,0	8	10	-	-	45	-	3
FLC3S07830S	-	7,8	8	10	-	-	45	-	3
FLC3S08030S	-	8,0	8	11	-	-	45	-	3
FLC3S08730S	-	8,7	10	11	-	-	50	-	3
FLC3S09030S	-	9,0	10	11	-	-	50	-	3
FLC3S09730S	-	9,7	10	11	-	-	50	-	3
FLC3S10030S	-	10,0	10	13	-	-	50	-	3
FLC3S12030S	-	12,0	12	15	-	-	55	-	3



3 flute end mill; 30° helix; SCT norm; stub length; TiCN coated

Schaftfräser 3 Schneiden; 30° Drallwinkel; SCT Norm; extra kurze Ausführung; TiCN beschichtet

Workpiece material groups and cutting speed / Werkstoffgruppen und Schnittgeschwindigkeiten

Material Material	Tensile strength Zugfestigkeit Rm [N/mm ²]	Hardness Härte [HB/HRC]	Cutting speed Vc [m/min] Schnittgeschwindigkeiten		
			min	opt	max
P1 Plain carbon steel / Unlegierter Stahl	< 600	< 230	130	180	225
P2 Alloy Steel / Legierter Stahl	< 1200	< 350	70	110	165
P3 High alloy steel and tool steel / Hochlegierter Stahl und Werkzeugstahl	< 1400	< 380	55	85	110
M1 Aust. and Ferr. Stainless steel / Aust. und Ferr. rostfreie Stähle	< 680	< 220	75	90	130
M2 Mart. Stainless steel / Mart. rostfreie Stähle	< 820	< 240	55	75	110
K1 Grey cast iron / Grauguß	-	< 280	110	135	165
K2 Ductile cast iron / Sphäroguß	-	< 320	90	110	130
N1 Non-ferrous alloys / Nichteisenmetalle	< 250	< 110	-	-	-
N2 Aluminium alloys / Aluminiumlegierungen	< 530	< 130	-	-	-
S1 High temperature alloys Fe, Ni and Co based / Warmfeste Leg. Fe, Ni und Co	< 3300	< 350	40	55	70
S2 Titanium alloys; Alpha and Beta / Titan Legierungen Alpha und Beta	< 2100	< 400	55	70	85
H1 Hardened steel / Gehärtete Stähle	-	< 54 HRC	-	-	-
H2 Hardened steel / Gehärtete Stähle	-	52-60 HRC	-	-	-
H3 Hardened steel / Gehärtete Stähle	-	> 58 HRC	-	-	-
G1 Graphite / Graphit	-	-	-	-	-

Cutting conditions / Zerspanungswerte

Peripheral milling / Umfangfräsen



Dc	Ap [0.5xD]	Ae 1 [0.2xD]	Ae 2	fz 1 ▼▼	fz 2 ▼
0,5	0,25	0,10	-	0,002	0,004
0,6	0,30	0,12	-	0,003	0,004
0,8	0,40	0,16	-	0,004	0,006
1,0	0,50	0,20	-	0,005	0,007
1,2	0,60	0,24	-	0,005	0,009
1,5	0,75	0,30	-	0,007	0,011
1,8	0,90	0,36	-	0,008	0,013
2,0	1,00	0,40	-	0,009	0,015
2,5	1,25	0,50	-	0,011	0,019
3,0	1,50	0,60	-	0,014	0,022
3,5	1,75	0,70	-	0,016	0,026
4,0	2,00	0,80	-	0,018	0,030
4,5	2,25	0,90	-	0,020	0,034
5,0	2,50	1,00	-	0,023	0,037
5,5	2,75	1,10	-	0,025	0,041
5,8	2,90	1,16	-	0,026	0,043
6,0	3,00	1,20	-	0,027	0,045
6,8	3,40	1,36	-	0,031	0,051
7,0	3,50	1,40	-	0,032	0,052
7,8	3,90	1,56	-	0,035	0,058
8,0	4,00	1,60	-	0,036	0,060
8,7	4,35	1,74	-	0,039	0,065
9,0	4,50	1,80	-	0,041	0,067
9,7	4,85	1,94	-	0,044	0,073
10,0	5,00	2,00	-	0,045	0,075
12,0	6,00	2,40	-	0,054	0,090

Slot milling / Vollnutfräsen



Dc	Ap [0.2xD]	Ae [1xD]	fz
0,5	0,1	0,5	0,002
0,6	0,1	0,6	0,002
0,8	0,2	0,8	0,002
1,0	0,2	1,0	0,003
1,2	0,2	1,2	0,004
1,5	0,3	1,5	0,005
1,8	0,4	1,8	0,005
2,0	0,4	2,0	0,006
2,5	0,5	2,5	0,008
3,0	0,6	3,0	0,009
3,5	0,7	3,5	0,011
4,0	0,8	4,0	0,012
4,5	0,9	4,5	0,014
5,0	1,0	5,0	0,015
5,5	1,1	5,5	0,017
5,8	1,2	5,8	0,017
6,0	1,2	6,0	0,018
6,8	1,4	6,8	0,020
7,0	1,4	7,0	0,021
7,8	1,6	7,8	0,023
8,0	1,6	8,0	0,024
8,7	1,7	8,7	0,026
9,0	1,8	9,0	0,027
9,7	1,9	9,7	0,029
10,0	2,0	10,0	0,030
12,0	2,4	12,0	0,036

3 flute end mill; 30° helix; SCT norm; stub length; TiCN coated

Schafffräser 3 Schneiden; 30° Drallwinkel; SCT Norm; extra kurze Ausführung; TiCN beschichtet

Specifications / Spezifikationen



DIN 6535 HA	DIN 6535 HB	Dc	Ds	Lc	Ln	Dn	Lt	r	z
FLC3S00530SC	-	0,5	3	1,5	-	-	40	-	3
FLC3S00630SC	-	0,6	3	1,5	-	-	40	-	3
FLC3S00830SC	-	0,8	3	2	-	-	40	-	3
FLC3S01030SC	-	1,0	3	2	-	-	40	-	3
FLC3S01230SC	-	1,2	3	2	-	-	40	-	3
FLC3S01530SC	-	1,5	3	2	-	-	40	-	3
FLC3S01830SC	-	1,8	3	2	-	-	40	-	3
FLC3S02030SC	-	2,0	6	4	-	-	40	-	3
FLC3S02530SC	-	2,5	6	5	-	-	40	-	3
FLC3S03030SC	-	3,0	6	5	-	-	40	-	3
FLC3S03530SC	-	3,5	6	6	-	-	40	-	3
FLC3S04030SC	-	4,0	6	7	-	-	40	-	3
FLC3S04530SC	-	4,5	6	8	-	-	40	-	3
FLC3S05030SC	-	5,0	6	8	-	-	40	-	3
FLC3S05530SC	-	5,5	6	8	-	-	40	-	3
FLC3S05830SC	-	5,8	6	8	-	-	40	-	3
FLC3S06030SC	-	6,0	6	8	-	-	40	-	3
FLC3S06830SC	-	6,8	8	10	-	-	45	-	3
FLC3S07030SC	-	7,0	8	10	-	-	45	-	3
FLC3S07830SC	-	7,8	8	10	-	-	45	-	3
FLC3S08030SC	-	8,0	8	11	-	-	45	-	3
FLC3S08730SC	-	8,7	10	11	-	-	50	-	3
FLC3S09030SC	-	9,0	10	11	-	-	50	-	3
FLC3S09730SC	-	9,7	10	11	-	-	50	-	3
FLC3S10030SC	-	10,0	10	13	-	-	50	-	3
FLC3S12030SC	-	12,0	12	15	-	-	55	-	3



3 flute end mill; 30° helix; SCT norm; long length; uncoated

Schaftfräser 3 Schneiden; 30° Drallwinkel; SCT Norm; lange Ausführung; unbeschichtet

Workpiece material groups and cutting speed / Werkstoffgruppen und Schnittgeschwindigkeiten

Material Material	Tensile strength Zugfestigkeit Rm [N/mm ²]	Hardness Härte [HB/HRC]	Cutting speed Vc [m/min] Schnittgeschwindigkeiten		
			min	opt	max
P1 Plain carbon steel / Unlegierter Stahl	< 600	< 230	85	130	155
P2 Alloy Steel / Legierter Stahl	< 1200	< 350	50	70	105
P3 High alloy steel and tool steel / Hochlegierter Stahl und Werkzeugstahl	< 1400	< 380	45	60	65
M1 Aust. and Ferr. Stainless steel / Aust. und Ferr. rostfreie Stähle	< 680	< 220	50	65	80
M2 Mart. Stainless steel / Mart. rostfreie Stähle	< 820	< 240	45	60	70
K1 Grey cast iron / Grauguß	-	< 280	70	100	115
K2 Ductile cast iron / Sphäroguß	-	< 320	60	70	85
N1 Non-ferrous alloys / Nichteisenmetalle	< 250	< 110	-	-	-
N2 Aluminium alloys / Aluminiumlegierungen	< 530	< 130	-	-	-
S1 High temperature alloys Fe, Ni and Co based / Warmfeste Leg. Fe, Ni und Co	< 3300	< 350	30	35	45
S2 Titanium alloys; Alpha and Beta / Titan Legierungen Alpha und Beta	< 2100	< 400	45	50	60
H1 Hardened steel / Gehärtete Stähle	-	< 54 HRC	-	-	-
H2 Hardened steel / Gehärtete Stähle	-	52-60 HRC	-	-	-
H3 Hardened steel / Gehärtete Stähle	-	> 58 HRC	-	-	-
G1 Graphite / Graphit	-	-	-	-	-

Cutting conditions / Zerspanungswerte

Peripheral milling / Umfangfräsen



Dc	Ap [1.5xD]	Ae 1 [0.2xD]	Ae 2	fz 1 ▼▼	fz 2 ▼
3,0	4,5	0,6	-	0,007	0,014
4,0	6,0	0,8	-	0,009	0,019
5,0	7,5	1,0	-	0,012	0,023
6,0	9,0	1,2	-	0,014	0,028
8,0	12,0	1,6	-	0,019	0,037
10,0	15,0	2,0	-	0,023	0,047
12,0	18,0	2,4	-	0,028	0,056
16,0	24,0	3,2	-	0,037	0,075
20,0	30,0	4,0	-	0,047	0,093

Slot milling / Vollnutfräsen



Dc	Ap [0.5xD]	Ae [1xD]	fz
3,0	1,5	3,0	0,007
4,0	2,0	4,0	0,009
5,0	2,5	5,0	0,012
6,0	3,0	6,0	0,014
8,0	4,0	8,0	0,019
10,0	5,0	10,0	0,023
12,0	6,0	12,0	0,028
16,0	8,0	16,0	0,037
20,0	10,0	20,0	0,047

3 flute end mill; 30° helix; SCT norm; long length; uncoated
 Schaftfräser 3 Schneiden; 30° Drallwinkel; SCT Norm; lange Ausführung; unbeschichtet

Specifications / Spezifikationen



DIN 6535 HA	DIN 6535 HB	Dc	Ds	Lc	Ln	Dn	Lt	r	z
FLC3L03030S	-	3,0	3	12	-	-	40	-	3
FLC3L04030S	-	4,0	4	12	-	-	40	-	3
FLC3L05030S	-	5,0	5	14	-	-	50	-	3
FLC3L06030S	-	6,0	6	16	-	-	50	-	3
FLC3L08030S	-	8,0	8	20	-	-	60	-	3
FLC3L10030S	-	10,0	10	22	-	-	70	-	3
FLC3L12030S	-	12,0	12	22	-	-	70	-	3
FLC3L16030S	-	16,0	16	25	-	-	75	-	3
FLC3L20030S	-	20,0	20	32	-	-	100	-	3



3 flute end mill; 30° helix; SCT norm; long length; TiCN coated

Schafffräser 3 Schneiden; 30° Drallwinkel; SCT Norm; lange Ausführung; TiCN beschichtet

Workpiece material groups and cutting speed / Werkstoffgruppen und Schnittgeschwindigkeiten

Material Material	Tensile strength Zugfestigkeit Rm [N/mm ²]	Hardness Härte [HB/HRC]	Cutting speed Vc [m/min] Schnittgeschwindigkeiten		
			min	opt	max
P1 Plain carbon steel / Unlegierter Stahl	< 600	< 230	110	165	200
P2 Alloy Steel / Legierter Stahl	< 1200	< 350	65	90	135
P3 High alloy steel and tool steel / Hochlegierter Stahl und Werkzeugstahl	< 1400	< 380	55	75	85
M1 Aust. and Ferr. Stainless steel / Aust. und Ferr. rostfreie Stähle	< 680	< 220	65	85	100
M2 Mart. Stainless steel / Mart. rostfreie Stähle	< 820	< 240	55	75	90
K1 Grey cast iron / Grauguß	-	< 280	90	130	145
K2 Ductile cast iron / Sphäroguß	-	< 320	75	90	110
N1 Non-ferrous alloys / Nichteisenmetalle	< 250	< 110	-	-	-
N2 Aluminium alloys / Aluminiumlegierungen	< 530	< 130	-	-	-
S1 High temperature alloys Fe, Ni and Co based / Warmfeste Leg. Fe, Ni und Co	< 3300	< 350	40	45	55
S2 Titanium alloys; Alpha and Beta / Titan Legierungen Alpha und Beta	< 2100	< 400	55	65	75
H1 Hardened steel / Gehärtete Stähle	-	< 54 HRC	-	-	-
H2 Hardened steel / Gehärtete Stähle	-	52-60 HRC	-	-	-
H3 Hardened steel / Gehärtete Stähle	-	> 58 HRC	-	-	-
G1 Graphite / Graphit	-	-	-	-	-

Cutting conditions / Zerspanungswerte

Peripheral milling / Umfangfräsen



Dc	Ap [1.5xD]	Ae 1 [0.2xD]	Ae 2	fz 1 ▼▼	fz 2 ▼
3,0	4,5	0,6	-	0,009	0,018
4,0	6,0	0,8	-	0,012	0,024
5,0	7,5	1,0	-	0,015	0,030
6,0	9,0	1,2	-	0,018	0,036
8,0	12,0	1,6	-	0,024	0,048
10,0	15,0	2,0	-	0,030	0,060
12,0	18,0	2,4	-	0,036	0,072
16,0	24,0	3,2	-	0,048	0,096
20,0	30,0	4,0	-	0,060	0,120

Slot milling / Vollnutfräsen



Dc	Ap [0.5xD]	Ae [1xD]	fz
3,0	1,5	3,0	0,009
4,0	2,0	4,0	0,012
5,0	2,5	5,0	0,015
6,0	3,0	6,0	0,018
8,0	4,0	8,0	0,024
10,0	5,0	10,0	0,030
12,0	6,0	12,0	0,036
16,0	8,0	16,0	0,048
20,0	10,0	20,0	0,060

3 flute end mill; 30° helix; SCT norm; long length; TiCN coated
 Schafffräser 3 Schneiden; 30° Drallwinkel; SCT Norm; lange Ausführung; TiCN beschichtet

Specifications / Spezifikationen



DIN 6535 HA	DIN 6535 HB	Dc	Ds	Lc	Ln	Dn	Lt	r	z
FLC3L03030SC	-	3,0	3	12	-	-	40	-	3
FLC3L04030SC	-	4,0	4	12	-	-	40	-	3
FLC3L05030SC	-	5,0	5	14	-	-	50	-	3
FLC3L06030SC	-	6,0	6	16	-	-	50	-	3
FLC3L08030SC	-	8,0	8	20	-	-	60	-	3
FLC3L10030SC	-	10,0	10	22	-	-	70	-	3
FLC3L12030SC	-	12,0	12	22	-	-	70	-	3
FLC3L16030SC	-	16,0	16	25	-	-	75	-	3
FLC3L20030SC	-	20,0	20	32	-	-	100	-	3



4 flute end mill; 30° helix; SCT norm; long length; uncoated

Schaftfräser 4 Schneiden; 30° Drallwinkel; SCT Norm; lange Ausführung; unbeschichtet

Workpiece material groups and cutting speed / Werkstoffgruppen und Schnittgeschwindigkeiten

Material Material	Tensile strength Zugfestigkeit Rm [N/mm ²]	Hardness Härte [HB/HRC]	Cutting speed Vc [m/min] Schnittgeschwindigkeiten		
			min	opt	max
P1 Plain carbon steel / Unlegierter Stahl	< 600	< 230	85	130	155
P2 Alloy Steel / Legierter Stahl	< 1200	< 350	50	70	105
P3 High alloy steel and tool steel / Hochlegierter Stahl und Werkzeugstahl	< 1400	< 380	45	60	65
M1 Aust. and Ferr. Stainless steel / Aust. und Ferr. rostfreie Stähle	< 680	< 220	50	65	80
M2 Mart. Stainless steel / Mart. rostfreie Stähle	< 820	< 240	45	60	70
K1 Grey cast iron / Grauguß	-	< 280	70	100	115
K2 Ductile cast iron / Sphäroguß	-	< 320	60	70	85
N1 Non-ferrous alloys / Nichteisenmetalle	< 250	< 110	-	-	-
N2 Aluminium alloys / Aluminiumlegierungen	< 530	< 130	-	-	-
S1 High temperature alloys Fe, Ni and Co based / Warmfeste Leg. Fe, Ni und Co	< 3300	< 350	30	35	45
S2 Titanium alloys; Alpha and Beta / Titan Legierungen Alpha und Beta	< 2100	< 400	45	50	60
H1 Hardened steel / Gehärtete Stähle	-	< 54 HRC	-	-	-
H2 Hardened steel / Gehärtete Stähle	-	52-60 HRC	-	-	-
H3 Hardened steel / Gehärtete Stähle	-	> 58 HRC	-	-	-
G1 Graphite / Graphit	-	-	-	-	-

Cutting conditions / Zerspanungswerte

Peripheral milling / Umfangfräsen



Dc	Ap	Ae 1	Ae 2	fz 1	fz 2
	[1.75xD]	[0.2xD]		▼▼	▼
3,0	5,3	0,6	-	0,007	0,014
4,0	7,0	0,8	-	0,009	0,019
5,0	8,8	1,0	-	0,012	0,023
6,0	10,5	1,2	-	0,014	0,028
8,0	14,0	1,6	-	0,019	0,037
10,0	17,5	2,0	-	0,023	0,047
12,0	21,0	2,4	-	0,028	0,056
16,0	28,0	3,2	-	0,037	0,075
20,0	35,0	4,0	-	0,047	0,093

4-flute end mill; 30° helix; SCT norm; long length; uncoated
 Schaftfräser 4 Schneiden; 30° Drallwinkel; SCT Norm; lange Ausführung; unbeschichtet

Specifications / Spezifikationen



DIN 6535 HA	DIN 6535 HB	Dc	Ds	Lc	Ln	Dn	Lt	r	z
FLC4L03030S	-	3,0	3	12	-	-	40	-	4
FLC4L04030S	-	4,0	4	12	-	-	40	-	4
FLC4L05030S	-	5,0	5	14	-	-	50	-	4
FLC4L06030S	-	6,0	6	16	-	-	50	-	4
FLC4L08030S	-	8,0	8	20	-	-	60	-	4
FLC4L10030S	-	10,0	10	22	-	-	70	-	4
FLC4L12030S	-	12,0	12	22	-	-	70	-	4
FLC4L16030S	-	16,0	16	25	-	-	75	-	4
FLC4L20030S	-	20,0	20	32	-	-	100	-	4



4 flute end mill; 30° helix; SCT norm; long length; TiCN coated

Schaftfräser 4 Schneiden; 30° Drallwinkel; SCT Norm; lange Ausführung; TiCN beschichtet

Workpiece material groups and cutting speed / Werkstoffgruppen und Schnittgeschwindigkeiten

Material Material	Tensile strength Zugfestigkeit Rm [N/mm ²]	Hardness Härte [HB/HRC]	Cutting speed Vc [m/min] Schnittgeschwindigkeiten		
			min	opt	max
P1 Plain carbon steel / Unlegierter Stahl	< 600	< 230	110	165	200
P2 Alloy Steel / Legierter Stahl	< 1200	< 350	65	90	135
P3 High alloy steel and tool steel / Hochlegierter Stahl und Werkzeugstahl	< 1400	< 380	55	75	85
M1 Aust. and Ferr. Stainless steel / Aust. und Ferr. rostfreie Stähle	< 680	< 220	65	85	100
M2 Mart. Stainless steel / Mart. rostfreie Stähle	< 820	< 240	55	75	90
K1 Grey cast iron / Grauguß	-	< 280	90	130	145
K2 Ductile cast iron / Sphäroguß	-	< 320	75	90	110
N1 Non-ferrous alloys / Nichteisenmetalle	< 250	< 110	-	-	-
N2 Aluminium alloys / Aluminiumlegierungen	< 530	< 130	-	-	-
S1 High temperature alloys Fe, Ni and Co based / Warmfeste Leg. Fe, Ni und Co	< 3300	< 350	40	45	55
S2 Titanium alloys; Alpha and Beta / Titan Legierungen Alpha und Beta	< 2100	< 400	55	65	75
H1 Hardened steel / Gehärtete Stähle	-	< 54 HRC	-	-	-
H2 Hardened steel / Gehärtete Stähle	-	52-60 HRC	-	-	-
H3 Hardened steel / Gehärtete Stähle	-	> 58 HRC	-	-	-
G1 Graphite / Graphit	-	-	-	-	-

Cutting conditions / Zerspanungswerte

Peripheral milling / Umfangfräsen



Dc	Ap	Ae 1	Ae 2	fz 1	fz 2
	[1.75xD]	[0.2xD]		▼▼	▼
3,0	5,3	0,6	-	0,009	0,018
4,0	7,0	0,8	-	0,012	0,024
5,0	8,8	1,0	-	0,015	0,030
6,0	10,5	1,2	-	0,018	0,036
8,0	14,0	1,6	-	0,024	0,048
10,0	17,5	2,0	-	0,030	0,060
12,0	21,0	2,4	-	0,036	0,072
16,0	28,0	3,2	-	0,048	0,096
20,0	35,0	4,0	-	0,060	0,120

4 flute end mill; 30° helix; SCT norm; long length; TiCN coated
 Schafffräser 4 Schneiden; 30° Drallwinkel; SCT Norm; lange Ausführung; TiCN beschichtet

Specifications / Spezifikationen



DIN 6535 HA	DIN 6535 HB	Dc	Ds	Lc	Ln	Dn	Lt	r	z
FLC4L03030SC	-	3,0	3	12	-	-	40	-	4
FLC4L04030SC	-	4,0	4	12	-	-	40	-	4
FLC4L05030SC	-	5,0	5	14	-	-	50	-	4
FLC4L06030SC	-	6,0	6	16	-	-	50	-	4
FLC4L08030SC	-	8,0	8	20	-	-	60	-	4
FLC4L10030SC	-	10,0	10	22	-	-	70	-	4
FLC4L12030SC	-	12,0	12	22	-	-	70	-	4
FLC4L16030SC	-	16,0	16	25	-	-	75	-	4
FLC4L20030SC	-	20,0	20	32	-	-	100	-	4





FLEXLINE
SOLID CARBIDE END MILLS®

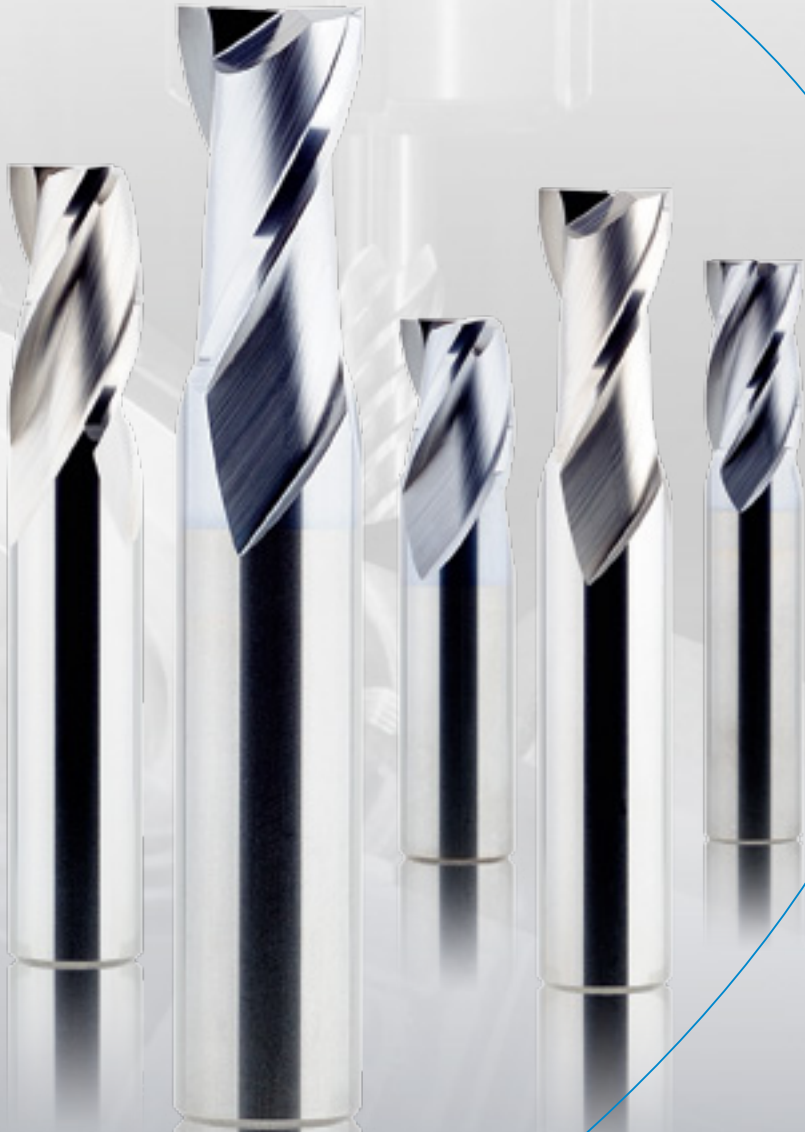

Improving Quality Through Innovation
Product of Holland

UK D



BASICLINE

SOLID CARBIDE END MILLS®



- ▶ Excellent price/performance ratio / Sehr gutes Preis/Leistungsverhältnis
- ▶ Universal geometries / Universal Geometrien
- ▶ Steel (<54 HRC) and non ferrous materials / Stahl (<54 HRC) und NE-Metalle
- ▶ Wide variety of applications / Vielfältige Anwendungsmöglichkeiten
- ▶ TiAlN coated / TiAlN beschichtet



Improving Quality Through Innovation

Product of Holland

Table of contents

Inhaltsverzeichnis









1 flute end mill; 30° helix; SCT norm; short length; uncoated Schafftfräser 1 Schneide; 30° Drallwinkel; SCT Norm; kurze Ausführung; unbeschichtet	4 - 5	
2 flute end mill; 45° helix; SCT norm; long length; uncoated Schafftfräser 2 Schneiden; 45° Drallwinkel; SCT Norm; lange Ausführung; unbeschichtet	6 - 7	
3 flute end mill; 45° helix; SCT norm; long length; uncoated Schafftfräser 3 Schneiden; 45° Drallwinkel; SCT Norm; lange Ausführung; unbeschichtet	8 - 9	
4 flute end mill; 38° helix; SCT norm; XL length; uncoated Schafftfräser 4 Schneiden; 38° Drallwinkel; SCT Norm; XL Ausführung; unbeschichtet	10 - 11	
3 flute rougher; 25° helix; SCT norm; long length; uncoated Schruppfräser 3 Schneiden; 25° Drallwinkel; SCT Norm; lange Ausführung; unbeschichtet	12 - 13	
2 flute end mill; 30° helix; DIN6527S; short length; TiAlN coated Schafftfräser 2 Schneiden; 30° Drallwinkel; DIN6527K; kurze Ausführung; TiAlN beschichtet	14 - 15	
2 flute end mill; 30° helix; DIN6527L; long length; TiAlN coated Schafftfräser 2 Schneiden; 30° Drallwinkel; DIN6527L; lange Ausführung; TiAlN beschichtet	16 - 17	
3 flute end mill; 30° helix; DIN6527S; short length; TiAlN coated Schafftfräser 3 Schneiden; 30° Drallwinkel; DIN6527K; kurze Ausführung; TiAlN beschichtet	18 - 19	
3 flute end mill; 30° helix; DIN6527L; long length; TiAlN coated Schafftfräser 3 Schneiden; 30° Drallwinkel; DIN6527L; lange Ausführung; TiAlN beschichtet	20 - 21	
3 flute end mill; 45° helix; DIN6527S; short length; TiAlN coated Schafftfräser 3 Schneiden; 45° Drallwinkel; DIN6527K; kurze Ausführung; TiAlN beschichtet	22 - 23	
3 flute end mill; 45° helix; DIN6527L; long length; TiAlN coated Schafftfräser 3 Schneiden; 45° Drallwinkel; DIN6527L; lange Ausführung; TiAlN beschichtet	24 - 25	
4 flute end mill; 30° helix; DIN6527S; short length; TiAlN coated Schafftfräser 4 Schneiden; 30° Drallwinkel; DIN6527K; kurze Ausführung; TiAlN beschichtet	26 - 27	
4 flute end mill; 30° helix; DIN6527L; long length; TiAlN coated Schafftfräser 4 Schneiden; 30° Drallwinkel; DIN6527L; lange Ausführung; TiAlN beschichtet	28 - 29	
Multi flute end mill; 45° helix; DIN6527L; long length; TiAlN coated Schafftfräser multi Schneiden; 45° Drallwinkel; DIN6527L; lange Ausführung; TiAlN beschichtet	30 - 31	
Multi flute end mill; 45° helix; SCT norm; XL length; TiAlN coated Schafftfräser multi Schneiden; 45° Drallwinkel; SCT Norm; XL Ausführung; TiAlN beschichtet	32 - 33	
Multi flute end mill; 45° helix; SCT norm; XXL length; TiAlN coated Schafftfräser multi Schneiden; 45° Drallwinkel; SCT Norm; XXL Ausführung; TiAlN beschichtet	34 - 35	
4 flute end mill; 35°-38° helix; DIN6527L; long length; TiAlN coated Schafftfräser 4 Schneiden; 35°-38° Drallwinkel; DIN6527L; lange Ausführung; TiAlN beschichtet	36 - 37	

Table of contents Inhaltsverzeichnis

Semi-Rougher; 45° helix; DIN6527L; long length; TiAlN coated Schrapp / Schlichtfräser; 45° Drallwinkel; DIN6527L; lange Ausführung; TiAlN beschichtet	38 - 39	
Multi flute rougher; 20° helix; DIN6527L; long length; TiAlN coated Schrappfräser multi Schneiden; 20° Drallwinkel; DIN6527L; lange Ausführung; TiAlN beschichtet	40 - 41	
Multi flute rougher; 45° helix; DIN6527L; long length; TiAlN coated Schrappfräser multi Schneiden; 45° Drallwinkel; DIN6527L; lange Ausführung; TiAlN beschichtet	42 - 43	
2 flute ball nose; 30° helix; DIN6527S; short length; TiAlN coated Radiusfräser 2 Schneiden; 30° Drallwinkel; DIN6527K; kurze Ausführung; TiAlN beschichtet	44 - 45	
2 flute ball nose; 30° helix; DIN6527L; long length; TiAlN coated Radiusfräser 2 Schneiden; 30° Drallwinkel; DIN6527L; lange Ausführung; TiAlN beschichtet	46 - 47	
4 flute chamfer end mill 90°; 0° helix; SCT norm; long length; TiAlN coated Entgratfräser 4 Schneiden 90°; 0° Drallwinkel; SCT Norm; lange Ausführung; TiAlN beschichtet	48 - 49	
4 flute chamfer end mill 60°; 0° helix; SCT norm; long length; TiAlN coated Entgratfräser 4 Schneiden 60°; 0° Drallwinkel; SCT Norm; lange Ausführung; TiAlN beschichtet	50 - 51	
4 flute chamfer end mill radius; 0° helix; SCT norm; long length; TiAlN coated Viertelkreisfräser 4 Schneiden; 0° Drallwinkel; SCT Norm; lange Ausführung; TiAlN beschichtet	52 - 53	

1 flute end mill; 30° helix; SCT norm; short length; uncoated

Schaftfräser 1 Schneide; 30° Drallwinkel; SCT Norm; kurze Ausführung; unbeschichtet

Workpiece material groups and cutting speed / Werkstoffgruppen und Schnittgeschwindigkeiten

Material Material	Tensile strength Zugfestigkeit Rm [N/mm ²]	Hardness Härte [HB/HRC]	Cutting speed Vc [m/min] Schnittgeschwindigkeiten		
			min	opt	max
P1 Plain carbon steel / Unlegierter Stahl	< 600	< 230	-	-	-
P2 Alloy Steel / Legierter Stahl	< 1200	< 350	-	-	-
P3 High alloy steel and tool steel / Hochlegierter Stahl und Werkzeugstahl	< 1400	< 380	-	-	-
M1 Aust. and Ferr. Stainless steel / Aust. und Ferr. rostfreie Stähle	< 680	< 220	-	-	-
M2 Mart. Stainless steel / Mart. rostfreie Stähle	< 820	< 240	-	-	-
K1 Grey cast iron / Grauguß	-	< 280	-	-	-
K2 Ductile cast iron / Sphäroguß	-	< 320	-	-	-
N1 Non-ferrous alloys / Nichteisenmetalle	< 250	< 110	120	160	350
N2 Aluminium alloys / Aluminiumlegierungen	< 530	< 130	150	220	300
S1 High temperature alloys Fe, Ni and Co based / Warmfeste Leg. Fe, Ni und Co	< 3300	< 350	-	-	-
S2 Titanium alloys; Alpha and Beta / Titan Legierungen Alpha und Beta	< 2100	< 400	-	-	-
H1 Hardened steel / Gehärtete Stähle	-	< 54 HRC	-	-	-
H2 Hardened steel / Gehärtete Stähle	-	52-60 HRC	-	-	-
H3 Hardened steel / Gehärtete Stähle	-	> 58 HRC	-	-	-
G1 Graphite / Graphit	-	-	-	-	-

Cutting conditions / Zerspanungswerte

Peripheral milling / Umfangfräsen



Dc	Ap [1.5xD]	Ae 1 [0.2xD]	Ae 2	fz 1 ▼▼	fz 2 ▼
3,0	4,50	0,60	-	0,015	0,025
4,0	6,00	0,80	-	0,020	0,033
5,0	7,50	1,00	-	0,025	0,042
6,0	9,00	1,20	-	0,030	0,050
8,0	12,00	1,60	-	0,040	0,067
10,0	15,00	2,00	-	0,050	0,083
12,0	18,00	2,40	-	0,060	0,100

Slot milling / Vollnutfräsen



Dc	Ap [1xD]	Ae [1xD]	fz
3,0	3,0	3,0	0,005
4,0	4,0	4,0	0,007
5,0	5,0	5,0	0,008
6,0	6,0	6,0	0,010
8,0	8,0	8,0	0,013
10,0	10,0	10,0	0,017
12,0	12,0	12,0	0,020

1 flute end mill; 30° helix; SCT norm; short length; uncoated
 Schaftfräser 1 Schneide; 30° Drallwinkel; SCT Norm; kurze Ausführung; unbeschichtet

Specifications / Spezifikationen



DIN 6535 HA	DIN 6535 HB	Dc	Ds	Lc	Ln	Dn	Lt	r	z
BLC1S03030S	-	3,0	6	8	-	-	50	-	1
BLC1S04030S	-	4,0	6	11	-	-	54	-	1
BLC1S05030S	-	5,0	6	13	-	-	54	-	1
BLC1S06030S	-	6,0	6	13	-	-	54	-	1
BLC1S08030S	-	8,0	8	19	-	-	58	-	1
BLC1S10030S	-	10,0	10	22	-	-	66	-	1
BLC1S12030S	-	12,0	12	26	-	-	73	-	1

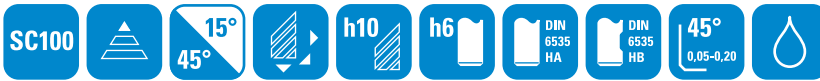

2 flute end mill; 45° helix; SCT norm; long length; uncoated
 Schaftfräser 2 Schneiden; 45° Drallwinkel; SCT Norm; lange Ausführung; unbeschichtet

Specifications / Spezifikationen

DIN 6535 HA	DIN 6535 HB	Dc	Ds	Lc	Ln	Dn	Lt	r	z
BLC2L03045S	BLW2L03045S	3,0	6	8	-	-	57	-	2
BLC2L03545S	BLW2L03545S	3,5	6	10	-	-	57	-	2
BLC2L04045S	BLW2L04045S	4,0	6	11	-	-	57	-	2
BLC2L04545S	BLW2L04545S	4,5	6	11	-	-	57	-	2
BLC2L05045S	BLW2L05045S	5,0	6	13	-	-	57	-	2
BLC2L06045S	BLW2L06045S	6,0	6	13	-	-	57	-	2
BLC2L07045S	BLW2L07045S	7,0	8	16	-	-	63	-	2
BLC2L08045S	BLW2L08045S	8,0	8	19	-	-	63	-	2
BLC2L09045S	BLW2L09045S	9,0	10	19	-	-	72	-	2
BLC2L10045S	BLW2L10045S	10,0	10	22	-	-	72	-	2
BLC2L12045S	BLW2L12045S	12,0	12	26	-	-	83	-	2
BLC2L14045S	BLW2L14045S	14,0	14	26	-	-	83	-	2
BLC2L16045S	BLW2L16045S	16,0	16	32	-	-	92	-	2
BLC2L18045S	BLW2L18045S	18,0	18	32	-	-	92	-	2
BLC2L20045S	BLW2L20045S	20,0	20	38	-	-	104	-	2



3 flute end mill; 45° helix; SCT norm; long length; uncoated

Schafffräser 3 Schneiden; 45° Drallwinkel; SCT Norm; lange Ausführung; unbeschichtet

Workpiece material groups and cutting speed / Werkstoffgruppen und Schnittgeschwindigkeiten

Material Material	Tensile strength Zugfestigkeit Rm [N/mm ²]	Hardness Härte [HB/HRC]	Cutting speed Vc [m/min] Schnittgeschwindigkeiten		
			min	opt	max
P1 Plain carbon steel / Unlegierter Stahl	< 600	< 230	-	-	-
P2 Alloy Steel / Legierter Stahl	< 1200	< 350	-	-	-
P3 High alloy steel and tool steel / Hochlegierter Stahl und Werkzeugstahl	< 1400	< 380	-	-	-
M1 Aust. and Ferr. Stainless steel / Aust. und Ferr. rostfreie Stähle	< 680	< 220	-	-	-
M2 Mart. Stainless steel / Mart. rostfreie Stähle	< 820	< 240	-	-	-
K1 Grey cast iron / Grauguß	-	< 280	-	-	-
K2 Ductile cast iron / Sphäroguß	-	< 320	-	-	-
N1 Non-ferrous alloys / Nichteisenmetalle	< 250	< 110	120	160	350
N2 Aluminium alloys / Aluminiumlegierungen	< 530	< 130	150	220	300
S1 High temperature alloys Fe, Ni and Co based / Warmfeste Leg. Fe, Ni und Co	< 3300	< 350	-	-	-
S2 Titanium alloys; Alpha and Beta / Titan Legierungen Alpha und Beta	< 2100	< 400	-	-	-
H1 Hardened steel / Gehärtete Stähle	-	< 54 HRC	-	-	-
H2 Hardened steel / Gehärtete Stähle	-	52-60 HRC	-	-	-
H3 Hardened steel / Gehärtete Stähle	-	> 58 HRC	-	-	-
G1 Graphite / Graphit	-	-	-	-	-

Cutting conditions / Zerspanungswerte

Peripheral milling / Umfangfräsen



Dc	Ap [1.5xD]	Ae 1 [0.2xD]	Ae 2	fz 1 ▼▼	fz 2 ▼
3,0	4,5	0,6	-	0,020	0,030
3,5	5,3	0,7	-	0,023	0,035
4,0	6,0	0,8	-	0,027	0,040
4,5	6,8	0,9	-	0,030	0,045
5,0	7,5	1,0	-	0,033	0,050
6,0	9,0	1,2	-	0,040	0,060
8,0	12,0	1,6	-	0,053	0,080
10,0	15,0	2,0	-	0,067	0,100
12,0	18,0	2,4	-	0,080	0,120
14,0	21,0	2,8	-	0,093	0,140
16,0	24,0	3,2	-	0,107	0,160
18,0	27,0	3,6	-	0,120	0,180
20,0	30,0	4,0	-	0,133	0,200

Slot milling / Vollnutfräsen



Dc	Ap [1xD]	Ae [1xD]	fz
3,0	3,0	3,0	0,010
3,5	3,5	3,5	0,012
4,0	4,0	4,0	0,013
4,5	4,5	4,5	0,015
5,0	5,0	5,0	0,017
6,0	6,0	6,0	0,020
8,0	8,0	8,0	0,027
10,0	10,0	10,0	0,033
12,0	12,0	12,0	0,040
14,0	14,0	14,0	0,047
16,0	16,0	16,0	0,053
18,0	18,0	18,0	0,060
20,0	20,0	20,0	0,067

3 flute end mill; 45° helix; SCT norm; long length; uncoated
 Schaftfräser 3 Schneiden; 45° Drallwinkel; SCT Norm; lange Ausführung; unbeschichtet

Specifications / Spezifikationen



DIN 6535 HA	DIN 6535 HB	Dc	Ds	Lc	Ln	Dn	Lt	r	z
BLC3L03045A	BLW3L03045A	3,0	6	8	-	-	57	-	3
BLC3L03545A	BLW3L03545A	3,5	6	10	-	-	57	-	3
BLC3L04045A	BLW3L04045A	4,0	6	11	-	-	57	-	3
BLC3L04545A	BLW3L04545A	4,5	6	11	-	-	57	-	3
BLC3L05045A	BLW3L05045A	5,0	6	13	-	-	57	-	3
BLC3L06045A	BLW3L06045A	6,0	6	13	-	-	57	-	3
BLC3L08045A	BLW3L08045A	8,0	8	19	-	-	63	-	3
BLC3L10045A	BLW3L10045A	10,0	10	22	-	-	72	-	3
BLC3L12045A	BLW3L12045A	12,0	12	26	-	-	83	-	3
BLC3L14045A	BLW3L14045A	14,0	14	26	-	-	83	-	3
BLC3L16045A	BLW3L16045A	16,0	16	32	-	-	92	-	3
BLC3L18045A	BLW3L18045A	18,0	18	32	-	-	92	-	3
BLC3L20045A	BLW3L20045A	20,0	20	38	-	-	104	-	3



4 flute end mill; 38° helix; SCT norm; XL length; uncoated

Schaftfräser 4 Schneiden; 38° Drallwinkel; SCT Norm; XL Ausführung; unbeschichtet

Workpiece material groups and cutting speed / Werkstoffgruppen und Schnittgeschwindigkeiten

Material Material	Tensile strength Zugfestigkeit Rm [N/mm ²]	Hardness Härte [HB/HRC]	Cutting speed Vc [m/min] Schnittgeschwindigkeiten		
			min	opt	max
P1 Plain carbon steel / Unlegierter Stahl	< 600	< 230	-	-	-
P2 Alloy Steel / Legierter Stahl	< 1200	< 350	-	-	-
P3 High alloy steel and tool steel / Hochlegierter Stahl und Werkzeugstahl	< 1400	< 380	-	-	-
M1 Aust. and Ferr. Stainless steel / Aust. und Ferr. rostfreie Stähle	< 680	< 220	-	-	-
M2 Mart. Stainless steel / Mart. rostfreie Stähle	< 820	< 240	-	-	-
K1 Grey cast iron / Grauguß	-	< 280	-	-	-
K2 Ductile cast iron / Sphäroguß	-	< 320	-	-	-
N1 Non-ferrous alloys / Nichteisenmetalle	< 250	< 110	120	160	350
N2 Aluminium alloys / Aluminiumlegierungen	< 530	< 130	150	220	300
S1 High temperature alloys Fe, Ni and Co based / Warmfeste Leg. Fe, Ni und Co	< 3300	< 350	-	-	-
S2 Titanium alloys; Alpha and Beta / Titan Legierungen Alpha und Beta	< 2100	< 400	-	-	-
H1 Hardened steel / Gehärtete Stähle	-	< 54 HRC	-	-	-
H2 Hardened steel / Gehärtete Stähle	-	52-60 HRC	-	-	-
H3 Hardened steel / Gehärtete Stähle	-	> 58 HRC	-	-	-
G1 Graphite / Graphit	-	-	-	-	-

Cutting conditions / Zerspanungswerte

Peripheral milling / Umfangfräsen



Dc	Ap [2.5xD]	Ae 1 [0.1xD]	Ae 2	fz 1 ▼▼	fz 2 ▼
4,0	10,0	0,4	-	0,027	0,040
5,0	12,5	0,5	-	0,033	0,050
6,0	15,0	0,6	-	0,040	0,060
8,0	20,0	0,8	-	0,053	0,080
10,0	25,0	1,0	-	0,067	0,100
12,0	30,0	1,2	-	0,080	0,120
16,0	40,0	1,6	-	0,107	0,160
20,0	50,0	2,0	-	0,133	0,200

4 flute end mill; 38° helix; SCT norm; XL length; uncoated
 Schaftfräser 4 Schneiden; 38° Drallwinkel; SCT Norm; XL Ausführung; unbeschichtet

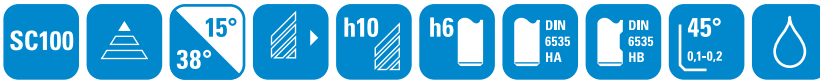
Specifications / Spezifikationen

DIN 6535 HA	DIN 6535 HB	Dc	Ds	Lc	Ln	Dn	Lt	r	z
BLC4L04038S	BLW4L04038S	4,0	6	15	-	-	62	-	4
BLC4L05038S	BLW4L05038S	5,0	6	18	-	-	62	-	4
BLC4L06038S	BLW4L06038S	6,0	6	18	-	-	62	-	4
BLC4L08038S	BLW4L08038S	8,0	8	24	-	-	68	-	4
BLC4L10038S	BLW4L10038S	10,0	10	30	-	-	80	-	4
BLC4L12038S	BLW4L12038S	12,0	12	36	-	-	93	-	4
BLC4L16038S	BLW4L16038S	16,0	16	48	-	-	108	-	4
BLC4L20038S	BLW4L20038S	20,0	20	60	-	-	126	-	4



3 flute rougher; 25° helix; SCT norm; long length; uncoated

Schrupfräser 3 Schneiden; 25° Drallwinkel; SCT Norm; lange Ausführung; unbeschichtet

Workpiece material groups and cutting speed / Werkstoffgruppen und Schnittgeschwindigkeiten

Material Material	Tensile strength Zugfestigkeit Rm [N/mm ²]	Hardness Härte [HB/HRC]	Cutting speed Vc [m/min] Schnittgeschwindigkeiten		
			min	opt	max
P1 Plain carbon steel / Unlegierter Stahl	< 600	< 230	-	-	-
P2 Alloy Steel / Legierter Stahl	< 1200	< 350	-	-	-
P3 High alloy steel and tool steel / Hochlegierter Stahl und Werkzeugstahl	< 1400	< 380	-	-	-
M1 Aust. and Ferr. Stainless steel / Aust. und Ferr. rostfreie Stähle	< 680	< 220	-	-	-
M2 Mart. Stainless steel / Mart. rostfreie Stähle	< 820	< 240	-	-	-
K1 Grey cast iron / Grauguß	-	< 280	-	-	-
K2 Ductile cast iron / Sphäroguß	-	< 320	-	-	-
N1 Non-ferrous alloys / Nichteisenmetalle	< 250	< 110	120	160	350
N2 Aluminium alloys / Aluminiumlegierungen	< 530	< 130	150	220	300
S1 High temperature alloys Fe, Ni and Co based / Warmfeste Leg. Fe, Ni und Co	< 3300	< 350	-	-	-
S2 Titanium alloys; Alpha and Beta / Titan Legierungen Alpha und Beta	< 2100	< 400	-	-	-
H1 Hardened steel / Gehärtete Stähle	-	< 54 HRC	-	-	-
H2 Hardened steel / Gehärtete Stähle	-	52-60 HRC	-	-	-
H3 Hardened steel / Gehärtete Stähle	-	> 58 HRC	-	-	-
G1 Graphite / Graphit	-	-	-	-	-

Cutting conditions / Zerspanungswerte

Peripheral milling / Umfangfräsen



Dc	Ap [2.0xD]	Ae 1 [0.4xD]	Ae 2	fz 1 ▼▼	fz 2 ▼
6,0	12,0	2,4	-	0,055	0,330
8,0	16,0	3,2	-	0,073	0,440
10,0	20,0	4,0	-	0,092	0,550
12,0	24,0	4,8	-	0,110	0,660
14,0	28,0	5,6	-	0,128	0,770
16,0	32,0	6,4	-	0,147	0,880
18,0	36,0	7,2	-	0,165	0,990
20,0	40,0	8,0	-	0,183	1,100

Slot milling / Vollnutfräsen



Dc	Ap [1.25xD]	Ae [1xD]	fz
6,0	7,5	6,0	0,040
8,0	10,0	8,0	0,053
10,0	12,5	10,0	0,067
12,0	15,0	12,0	0,080
14,0	17,5	14,0	0,093
16,0	20,0	16,0	0,107
18,0	22,5	18,0	0,120
20,0	25,0	20,0	0,133

3 flute rougher; 25° helix; SCT norm; long length; uncoated
 Schruppfräser 3 Schneiden; 25° Drallwinkel; SCT Norm; lange Ausführung; unbeschichtet

Specifications / Spezifikationen

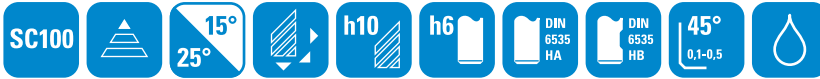

DIN 6535 HA	DIN 6535 HB	Dc	Ds	Lc	Ln	Dn	Lt	r	z
BLC3L06025R	BLW3L06025R	6,0	6	13	-	-	57	-	3
BLC3L08025R	BLW3L08025R	8,0	8	19	-	-	63	-	3
BLC3L10025R	BLW3L10025R	10,0	10	22	-	-	72	-	3
BLC3L12025R	BLW3L12025R	12,0	12	26	-	-	83	-	3
BLC3L14025R	BLW3L14025R	14,0	14	26	-	-	83	-	3
BLC3L16025R	BLW3L16025R	16,0	16	32	-	-	92	-	3
BLC3L18025R	BLW3L18025R	18,0	18	32	-	-	92	-	3
BLC3L20025R	BLW3L20025R	20,0	20	38	-	-	104	-	3



2 flute end mill; 30° helix; DIN6527S; short length; TiAlN coated
 Schafffräser 2 Schneiden; 30° Drallwinkel; DIN6527K; kurze Ausführung; TiAlN beschichtet

Specifications / Spezifikationen

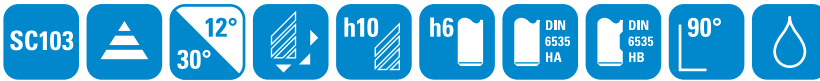

DIN 6535 HA	DIN 6535 HB	Dc	Ds	Lc	Ln	Dn	Lt	r	z
BLC2S03030S	BLW2S03030S	3,0	6	4	-	-	50	-	2
BLC2S03530S	BLW2S03530S	3,5	6	4	-	-	50	-	2
BLC2S04030S	BLW2S04030S	4,0	6	5	-	-	54	-	2
BLC2S04530S	BLW2S04530S	4,5	6	5	-	-	54	-	2
BLC2S05030S	BLW2S05030S	5,0	6	6	-	-	54	-	2
BLC2S06030S	BLW2S06030S	6,0	6	7	-	-	54	-	2
BLC2S07030S	BLW2S07030S	7,0	8	8	-	-	58	-	2
BLC2S08030S	BLW2S08030S	8,0	8	9	-	-	58	-	2
BLC2S09030S	BLW2S09030S	9,0	10	10	-	-	66	-	2
BLC2S10030S	BLW2S10030S	10,0	10	11	-	-	66	-	2
BLC2S12030S	BLW2S12030S	12,0	12	12	-	-	73	-	2
BLC2S14030S	BLW2S14030S	14,0	14	14	-	-	73	-	2
BLC2S16030S	BLW2S16030S	16,0	16	16	-	-	82	-	2
BLC2S18030S	BLW2S18030S	18,0	18	18	-	-	84	-	2
BLC2S20030S	BLW2S20030S	20,0	20	20	-	-	92	-	2



2 flute end mill; 30° helix; DIN6527L; long length; TiAlN coated

Schafffräser 2 Schneiden; 30° Drallwinkel; DIN6527L; lange Ausführung; TiAlN beschichtet

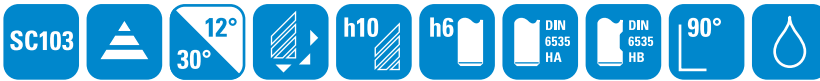
Specifications / Spezifikationen

DIN 6535 HA	DIN 6535 HB	Dc	Ds	Lc	Ln	Dn	Lt	r	z
BLC2L03030S	BLW2L03030S	3,0	6	7	-	-	57	-	2
BLC2L03530S	BLW2L03530S	3,5	6	7	-	-	57	-	2
BLC2L04030S	BLW2L04030S	4,0	6	8	-	-	57	-	2
BLC2L04530S	BLW2L04530S	4,5	6	8	-	-	57	-	2
BLC2L05030S	BLW2L05030S	5,0	6	10	-	-	57	-	2
BLC2L06030S	BLW2L06030S	6,0	6	10	-	-	57	-	2
BLC2L07030S	BLW2L07030S	7,0	8	13	-	-	63	-	2
BLC2L08030S	BLW2L08030S	8,0	8	16	-	-	63	-	2
BLC2L09030S	BLW2L09030S	9,0	10	16	-	-	72	-	2
BLC2L10030S	BLW2L10030S	10,0	10	19	-	-	72	-	2
BLC2L12030S	BLW2L12030S	12,0	12	22	-	-	83	-	2
BLC2L14030S	BLW2L14030S	14,0	14	22	-	-	83	-	2
BLC2L16030S	BLW2L16030S	16,0	16	26	-	-	92	-	2
BLC2L18030S	BLW2L18030S	18,0	18	26	-	-	92	-	2
BLC2L20030S	BLW2L20030S	20,0	20	32	-	-	104	-	2



3 flute end mill; 30° helix; DIN6527S; short length; TiAlN coated

Schafffräser 3 Schneiden; 30° Drallwinkel; DIN6527K; kurze Ausführung; TiAlN beschichtet

Workpiece material groups and cutting speed / Werkstoffgruppen und Schnittgeschwindigkeiten

Material Material	Tensile strength Zugfestigkeit Rm [N/mm ²]	Hardness Härte [HB/HRC]	Cutting speed Vc [m/min] Schnittgeschwindigkeiten		
			min	opt	max
P1 Plain carbon steel / Unlegierter Stahl	< 600	< 230	140	200	250
P2 Alloy Steel / Legierter Stahl	< 1200	< 350	75	120	180
P3 High alloy steel and tool steel / Hochlegierter Stahl und Werkzeugstahl	< 1400	< 380	60	90	120
M1 Aust. and Ferr. Stainless steel / Aust. und Ferr. rostfreie Stähle	< 680	< 220	80	100	140
M2 Mart. Stainless steel / Mart. rostfreie Stähle	< 820	< 240	60	80	120
K1 Grey cast iron / Grauguß	-	< 280	120	150	180
K2 Ductile cast iron / Sphäroguß	-	< 320	100	120	140
N1 Non-ferrous alloys / Nichteisenmetalle	< 250	< 110	-	-	-
N2 Aluminium alloys / Aluminiumlegierungen	< 530	< 130	-	-	-
S1 High temperature alloys Fe, Ni and Co based / Warmfeste Leg. Fe, Ni und Co	< 3300	< 350	40	60	75
S2 Titanium alloys; Alpha and Beta / Titan Legierungen Alpha und Beta	< 2100	< 400	60	75	90
H1 Hardened steel / Gehärtete Stähle	-	< 54 HRC	-	-	-
H2 Hardened steel / Gehärtete Stähle	-	52-60 HRC	-	-	-
H3 Hardened steel / Gehärtete Stähle	-	> 58 HRC	-	-	-
G1 Graphite / Graphit	-	-	-	-	-

Cutting conditions / Zerspanungswerte

Peripheral milling / Umfangfräsen



Dc	Ap	Ae 1	Ae 2	fz 1	fz 2
	[0.75xD]	[0.2xD]		▼▼	▼
3,0	2,3	0,6	-	0,015	0,025
3,5	2,7	0,7	-	0,018	0,029
4,0	3,0	0,8	-	0,020	0,033
4,5	3,4	0,9	-	0,023	0,037
5,0	3,8	1,0	-	0,025	0,042
6,0	4,5	1,2	-	0,030	0,050
8,0	6,0	1,6	-	0,040	0,067
10,0	7,5	2,0	-	0,050	0,083
12,0	9,0	2,4	-	0,060	0,100
14,0	10,5	2,8	-	0,070	0,117
16,0	12,0	3,2	-	0,080	0,133
18,0	13,5	3,6	-	0,090	0,150
20,0	15,0	4,0	-	0,100	0,167

Slot milling / Vollnutfräsen



Dc	Ap	Ae	fz
	[0.25xD]	[1xD]	
3,0	0,8	3,0	0,010
3,5	0,9	3,5	0,012
4,0	1,0	4,0	0,013
4,5	1,1	4,5	0,015
5,0	1,3	5,0	0,017
6,0	1,5	6,0	0,020
8,0	2,0	8,0	0,027
10,0	2,5	10,0	0,033
12,0	3,0	12,0	0,040
14,0	3,5	14,0	0,047
16,0	4,0	16,0	0,053
18,0	4,6	18,5	0,062
20,0	5,0	20,0	0,067

3 flute end mill; 30° helix; DIN6527S; short length; TiAlN coated
 Schafffräser 3 Schneiden; 30° Drallwinkel; DIN6527K; kurze Ausführung; TiAlN beschichtet

Specifications / Spezifikationen

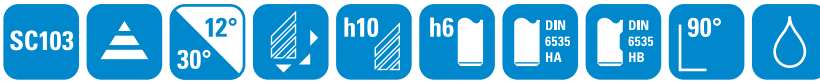

DIN 6535 HA	DIN 6535 HB	Dc	Ds	Lc	Ln	Dn	Lt	r	z
BLC3S03030S	BLW3S03030S	3,0	6	4	-	-	50	-	3
BLC3S03530S	BLW3S03530S	3,5	6	4	-	-	50	-	3
BLC3S04030S	BLW3S04030S	4,0	6	5	-	-	54	-	3
BLC3S04530S	BLW3S04530S	4,5	6	5	-	-	54	-	3
BLC3S05030S	BLW3S05030S	5,0	6	6	-	-	54	-	3
BLC3S06030S	BLW3S06030S	6,0	6	7	-	-	54	-	3
BLC3S08030S	BLW3S08030S	8,0	8	9	-	-	58	-	3
BLC3S10030S	BLW3S10030S	10,0	10	11	-	-	66	-	3
BLC3S12030S	BLW3S12030S	12,0	12	12	-	-	73	-	3
BLC3S14030S	BLW3S14030S	14,0	14	14	-	-	73	-	3
BLC3S16030S	BLW3S16030S	16,0	16	16	-	-	82	-	3
BLC3S18030S	BLW3S18030S	18,0	18	18	-	-	84	-	3
BLC3S20030S	BLW3S20030S	20,0	20	20	-	-	92	-	3



3 flute end mill; 30° helix; DIN6527L; long length; TiAlN coated

Schafffräser 3 Schneiden; 30° Drallwinkel; DIN6527L; lange Ausführung; TiAlN beschichtet

Workpiece material groups and cutting speed / Werkstoffgruppen und Schnittgeschwindigkeiten

Material Material	Tensile strength Zugfestigkeit Rm [N/mm ²]	Hardness Härte [HB/HRC]	Cutting speed Vc [m/min] Schnittgeschwindigkeiten		
			min	opt	max
P1 Plain carbon steel / Unlegierter Stahl	< 600	< 230	120	180	220
P2 Alloy Steel / Legierter Stahl	< 1200	< 350	70	100	150
P3 High alloy steel and tool steel / Hochlegierter Stahl und Werkzeugstahl	< 1400	< 380	60	80	90
M1 Aust. and Ferr. Stainless steel / Aust. und Ferr. rostfreie Stähle	< 680	< 220	70	90	110
M2 Mart. Stainless steel / Mart. rostfreie Stähle	< 820	< 240	60	80	100
K1 Grey cast iron / Grauguß	-	< 280	100	140	160
K2 Ductile cast iron / Sphäroguß	-	< 320	80	100	120
N1 Non-ferrous alloys / Nichteisenmetalle	< 250	< 110	-	-	-
N2 Aluminium alloys / Aluminiumlegierungen	< 530	< 130	-	-	-
S1 High temperature alloys Fe, Ni and Co based / Warmfeste Leg. Fe, Ni und Co	< 3300	< 350	40	50	60
S2 Titanium alloys; Alpha and Beta / Titan Legierungen Alpha und Beta	< 2100	< 400	60	70	80
H1 Hardened steel / Gehärtete Stähle	-	< 54 HRC	-	-	-
H2 Hardened steel / Gehärtete Stähle	-	52-60 HRC	-	-	-
H3 Hardened steel / Gehärtete Stähle	-	> 58 HRC	-	-	-
G1 Graphite / Graphit	-	-	-	-	-

Cutting conditions / Zerspanungswerte

Peripheral milling / Umfangfräsen



Dc	Ap [1.5xD]	Ae 1 [0.2xD]	Ae 2	fz 1 ▼▼	fz 2 ▼
3,0	4,5	0,6	-	0,010	0,020
3,5	5,3	0,7	-	0,012	0,023
4,0	6,0	0,8	-	0,013	0,027
4,5	6,8	0,9	-	0,015	0,030
5,0	7,5	1,0	-	0,017	0,033
6,0	9,0	1,2	-	0,020	0,040
8,0	12,0	1,6	-	0,027	0,053
10,0	15,0	2,0	-	0,033	0,067
12,0	18,0	2,4	-	0,040	0,080
14,0	21,0	2,8	-	0,047	0,093
16,0	24,0	3,2	-	0,053	0,107
18,0	27,0	3,6	-	0,060	0,120
20,0	30,0	4,0	-	0,067	0,133

Slot milling / Vollnutfräsen



Dc	Ap [0.5xD]	Ae [1xD]	fz
3,0	1,5	3,0	0,010
3,5	1,8	3,5	0,012
4,0	2,0	4,0	0,013
4,5	2,3	4,5	0,015
5,0	2,5	5,0	0,017
6,0	3,0	6,0	0,020
8,0	4,0	8,0	0,027
10,0	5,0	10,0	0,033
12,0	6,0	12,0	0,040
14,0	7,0	14,0	0,047
16,0	8,0	16,0	0,053
18,0	9,0	18,0	0,060
20,0	10,0	20,0	0,067

3 flute end mill; 30° helix; DIN6527L; long length; TiAlN coated
 Schafffräser 3 Schneiden; 30° Drallwinkel; DIN6527L; lange Ausführung; TiAlN beschichtet

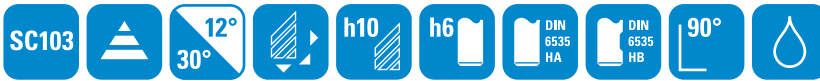
Specifications / Spezifikationen

DIN 6535 HA	DIN 6535 HB	Dc	Ds	Lc	Ln	Dn	Lt	r	z
BLC3L03030S	BLW3L03030S	3,0	6	7	-	-	57	-	3
BLC3L03530S	BLW3L03530S	3,5	6	7	-	-	57	-	3
BLC3L04030S	BLW3L04030S	4,0	6	8	-	-	57	-	3
BLC3L04530S	BLW3L04530S	4,5	6	8	-	-	57	-	3
BLC3L05030S	BLW3L05030S	5,0	6	10	-	-	57	-	3
BLC3L06030S	BLW3L06030S	6,0	6	10	-	-	57	-	3
BLC3L08030S	BLW3L08030S	8,0	8	16	-	-	63	-	3
BLC3L10030S	BLW3L10030S	10,0	10	19	-	-	72	-	3
BLC3L12030S	BLW3L12030S	12,0	12	22	-	-	83	-	3
BLC3L14030S	BLW3L14030S	14,0	14	22	-	-	83	-	3
BLC3L16030S	BLW3L16030S	16,0	16	26	-	-	92	-	3
BLC3L18030S	BLW3L18030S	18,0	18	26	-	-	92	-	3
BLC3L20030S	BLW3L20030S	20,0	20	32	-	-	104	-	3



3 flute end mill; 45° helix; DIN6527S; short length; TiAlN coated

Schaftfräser 3 Schneiden; 45° Drallwinkel; DIN6527K; kurze Ausführung; TiAlN beschichtet

Workpiece material groups and cutting speed / Werkstoffgruppen und Schnittgeschwindigkeiten

Material Material	Tensile strength Zugfestigkeit Rm [N/mm ²]	Hardness Härte [HB/HRC]	Cutting speed Vc [m/min] Schnittgeschwindigkeiten		
			min	opt	max
P1 Plain carbon steel / Unlegierter Stahl	< 600	< 230	140	200	250
P2 Alloy Steel / Legierter Stahl	< 1200	< 350	75	120	180
P3 High alloy steel and tool steel / Hochlegierter Stahl und Werkzeugstahl	< 1400	< 380	60	90	120
M1 Aust. and Ferr. Stainless steel / Aust. und Ferr. rostfreie Stähle	< 680	< 220	80	100	140
M2 Mart. Stainless steel / Mart. rostfreie Stähle	< 820	< 240	60	80	120
K1 Grey cast iron / Grauguß	-	< 280	120	150	180
K2 Ductile cast iron / Sphäroguß	-	< 320	100	120	140
N1 Non-ferrous alloys / Nichteisenmetalle	< 250	< 110	-	-	-
N2 Aluminium alloys / Aluminiumlegierungen	< 530	< 130	-	-	-
S1 High temperature alloys Fe, Ni and Co based / Warmfeste Leg. Fe, Ni und Co	< 3300	< 350	40	60	75
S2 Titanium alloys; Alpha and Beta / Titan Legierungen Alpha und Beta	< 2100	< 400	60	75	90
H1 Hardened steel / Gehärtete Stähle	-	< 54 HRC	40	60	80
H2 Hardened steel / Gehärtete Stähle	-	52-60 HRC	-	-	-
H3 Hardened steel / Gehärtete Stähle	-	> 58 HRC	-	-	-
G1 Graphite / Graphit	-	-	-	-	-

Cutting conditions / Zerspanungswerte

Peripheral milling / Umfangfräsen



Dc	Ap	Ae 1	Ae 2	fz 1	fz 2
[0.75xD]	[0.2xD]	[0.2xD]		▼▼	▼
3,0	2,3	0,6	-	0,025	0,035
3,5	2,6	0,7	-	0,029	0,041
4,0	3,0	0,8	-	0,033	0,047
4,5	3,4	0,9	-	0,037	0,053
5,0	3,8	1,0	-	0,042	0,058
6,0	4,5	1,2	-	0,050	0,070
8,0	6,0	1,6	-	0,067	0,093
10,0	7,5	2,0	-	0,083	0,117
12,0	9,0	2,4	-	0,100	0,140
14,0	10,5	2,8	-	0,117	0,163
16,0	12,0	3,2	-	0,133	0,187
18,0	13,5	3,6	-	0,150	0,210
20,0	15,0	4,0	-	0,167	0,233

Slot milling / Vollnutfräsen



Dc	Ap	Ae	fz
[0.25xD]	[0.25xD]	[1xD]	
3,0	0,8	3,0	0,015
3,5	0,9	3,5	0,018
4,0	1,0	4,0	0,020
4,5	1,1	4,5	0,023
5,0	1,3	5,0	0,025
6,0	1,5	6,0	0,030
8,0	2,0	8,0	0,040
10,0	2,5	10,0	0,050
12,0	3,0	12,0	0,060
14,0	3,5	14,0	0,070
16,0	4,0	16,0	0,080
18,0	4,5	18,0	0,090
20,0	5,0	20,0	0,100

3 flute end mill; 45° helix; DIN6527S; short length; TiAlN coated
 Schafffräser 3 Schneiden; 45° Drallwinkel; DIN6527K; kurze Ausführung; TiAlN beschichtet

Specifications / Spezifikationen

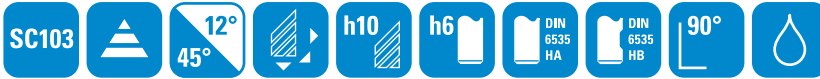

DIN 6535 HA	DIN 6535 HB	Dc	Ds	Lc	Ln	Dn	Lt	r	z
BLC3S03045S	BLW3S03045S	3,0	6	4	-	-	50	-	3
BLC3S03545S	BLW3S03545S	3,5	6	4	-	-	50	-	3
BLC3S04045S	BLW3S04045S	4,0	6	5	-	-	54	-	3
BLC3S04545S	BLW3S04545S	4,5	6	5	-	-	54	-	3
BLC3S05045S	BLW3S05045S	5,0	6	6	-	-	54	-	3
BLC3S06045S	BLW3S06045S	6,0	6	7	-	-	54	-	3
BLC3S08045S	BLW3S08045S	8,0	8	9	-	-	58	-	3
BLC3S10045S	BLW3S10045S	10,0	10	11	-	-	66	-	3
BLC3S12045S	BLW3S12045S	12,0	12	12	-	-	73	-	3
BLC3S14045S	BLW3S14045S	14,0	14	14	-	-	73	-	3
BLC3S16045S	BLW3S16045S	16,0	16	16	-	-	82	-	3
BLC3S18045S	BLW3S18045S	18,0	18	18	-	-	84	-	3
BLC3S20045S	BLW3S20045S	20,0	20	20	-	-	92	-	3



3 flute end mill; 45° helix; DIN6527L; long length; TiAlN coated

Schafffräser 3 Schneiden; 45° Drallwinkel; DIN6527L; lange Ausführung; TiAlN beschichtet

Workpiece material groups and cutting speed / Werkstoffgruppen und Schnittgeschwindigkeiten

Material Material	Tensile strength Zugfestigkeit Rm [N/mm ²]	Hardness Härte [HB/HRC]	Cutting speed Vc [m/min] Schnittgeschwindigkeiten		
			min	opt	max
P1 Plain carbon steel / Unlegierter Stahl	< 600	< 230	120	180	220
P2 Alloy Steel / Legierter Stahl	< 1200	< 350	70	100	150
P3 High alloy steel and tool steel / Hochlegierter Stahl und Werkzeugstahl	< 1400	< 380	60	80	90
M1 Aust. and Ferr. Stainless steel / Aust. und Ferr. rostfreie Stähle	< 680	< 220	70	90	110
M2 Mart. Stainless steel / Mart. rostfreie Stähle	< 820	< 240	60	80	100
K1 Grey cast iron / Grauguß	-	< 280	100	140	160
K2 Ductile cast iron / Sphäroguß	-	< 320	80	100	120
N1 Non-ferrous alloys / Nichteisenmetalle	< 250	< 110	-	-	-
N2 Aluminium alloys / Aluminiumlegierungen	< 530	< 130	-	-	-
S1 High temperature alloys Fe, Ni and Co based / Warmfeste Leg. Fe, Ni und Co	< 3300	< 350	40	50	60
S2 Titanium alloys; Alpha and Beta / Titan Legierungen Alpha und Beta	< 2100	< 400	60	70	80
H1 Hardened steel / Gehärtete Stähle	-	< 54 HRC	-	-	-
H2 Hardened steel / Gehärtete Stähle	-	52-60 HRC	-	-	-
H3 Hardened steel / Gehärtete Stähle	-	> 58 HRC	-	-	-
G1 Graphite / Graphit	-	-	-	-	-

Cutting conditions / Zerspanungswerte

Peripheral milling / Umfangfräsen



Dc	Ap [1.5xD]	Ae 1 [0.2xD]	Ae 2	fz 1 ▼▼	fz 2 ▼
3,0	4,5	0,6	-	0,020	0,030
3,5	5,3	0,7	-	0,023	0,035
4,0	6,0	0,8	-	0,027	0,040
4,5	6,8	0,9	-	0,030	0,045
5,0	7,5	1,0	-	0,033	0,050
6,0	9,0	1,2	-	0,040	0,060
8,0	12,0	1,6	-	0,053	0,080
10,0	15,0	2,0	-	0,067	0,100
12,0	18,0	2,4	-	0,080	0,120
14,0	21,0	2,8	-	0,093	0,140
16,0	24,0	3,2	-	0,107	0,160
18,0	27,0	3,6	-	0,120	0,180
20,0	30,0	4,0	-	0,133	0,200

Slot milling / Vollnutfräsen



Dc	Ap [0.5xD]	Ae [1xD]	fz
3,0	1,5	3,0	0,010
3,5	1,8	3,5	0,012
4,0	2,0	4,0	0,013
4,5	2,3	4,5	0,015
5,0	2,5	5,0	0,017
6,0	3,0	6,0	0,020
8,0	4,0	8,0	0,027
10,0	5,0	10,0	0,033
12,0	6,0	12,0	0,040
14,0	7,0	14,0	0,047
16,0	8,0	16,0	0,053
18,0	9,0	18,0	0,060
20,0	10,0	20,0	0,067

3 flute end mill; 45° helix; DIN6527L; long length; TiAlN coated

Schaftfräser 3 Schneiden; 45° Drallwinkel; DIN6527L; lange Ausführung; TiAlN beschichtet

Specifications / Spezifikationen



DIN 6535 HA	DIN 6535 HB	Dc	Ds	Lc	Ln	Dn	Lt	r	z
BLC3L03045S	BLW3L03045S	3,0	6	7	-	-	57	-	3
BLC3L03545S	BLW3L03545S	3,5	6	7	-	-	57	-	3
BLC3L04045S	BLW3L04045S	4,0	6	8	-	-	57	-	3
BLC3L04545S	BLW3L04545S	4,5	6	8	-	-	57	-	3
BLC3L05045S	BLW3L05045S	5,0	6	10	-	-	57	-	3
BLC3L06045S	BLW3L06045S	6,0	6	10	-	-	57	-	3
BLC3L08045S	BLW3L08045S	8,0	8	16	-	-	63	-	3
BLC3L10045S	BLW3L10045S	10,0	10	19	-	-	72	-	3
BLC3L12045S	BLW3L12045S	12,0	12	22	-	-	83	-	3
BLC3L14045S	BLW3L14045S	14,0	14	22	-	-	83	-	3
BLC3L16045S	BLW3L16045S	16,0	16	26	-	-	92	-	3
BLC3L18045S	BLW3L18045S	18,0	18	26	-	-	92	-	3
BLC3L20045S	BLW3L20045S	20,0	20	32	-	-	104	-	3



4 flute end mill; 30° helix; DIN6527S; short length; TiAlN coated

Schaftfräser 4 Schneiden; 30° Drallwinkel; DIN6527K; kurze Ausführung; TiAlN beschichtet

Workpiece material groups and cutting speed / Werkstoffgruppen und Schnittgeschwindigkeiten

Material Material	Tensile strength Zugfestigkeit Rm [N/mm ²]	Hardness Härte [HB/HRC]	Cutting speed Vc [m/min] Schnittgeschwindigkeiten		
			min	opt	max
P1 Plain carbon steel / Unlegierter Stahl	< 600	< 230	140	200	250
P2 Alloy Steel / Legierter Stahl	< 1200	< 350	75	120	180
P3 High alloy steel and tool steel / Hochlegierter Stahl und Werkzeugstahl	< 1400	< 380	60	90	120
M1 Aust. and Ferr. Stainless steel / Aust. und Ferr. rostfreie Stähle	< 680	< 220	80	100	140
M2 Mart. Stainless steel / Mart. rostfreie Stähle	< 820	< 240	60	80	120
K1 Grey cast iron / Grauguß	-	< 280	120	150	180
K2 Ductile cast iron / Sphäroguß	-	< 320	100	120	140
N1 Non-ferrous alloys / Nichteisenmetalle	< 250	< 110	-	-	-
N2 Aluminium alloys / Aluminiumlegierungen	< 530	< 130	-	-	-
S1 High temperature alloys Fe, Ni and Co based / Warmfeste Leg. Fe, Ni und Co	< 3300	< 350	40	60	75
S2 Titanium alloys; Alpha and Beta / Titan Legierungen Alpha und Beta	< 2100	< 400	60	75	90
H1 Hardened steel / Gehärtete Stähle	-	< 54 HRC	-	-	-
H2 Hardened steel / Gehärtete Stähle	-	52-60 HRC	-	-	-
H3 Hardened steel / Gehärtete Stähle	-	> 58 HRC	-	-	-
G1 Graphite / Graphit	-	-	-	-	-

Cutting conditions / Zerspanungswerte

Peripheral milling / Umfangfräsen



Dc	Ap [1x0]	Ae 1 [0.2xD]	Ae 2	fz 1 ▼▼	fz 2 ▼
3,0	3,0	0,6	-	0,015	0,025
3,5	3,5	0,7	-	0,018	0,029
4,0	4,0	0,8	-	0,020	0,033
4,5	4,5	0,9	-	0,023	0,037
5,0	5,0	1,0	-	0,025	0,042
6,0	6,0	1,2	-	0,030	0,050
8,0	8,0	1,6	-	0,040	0,067
10,0	10,0	2,0	-	0,050	0,083
12,0	12,0	2,4	-	0,060	0,100
14,0	14,0	2,8	-	0,070	0,117
16,0	16,0	3,2	-	0,080	0,133
18,0	18,0	3,6	-	0,090	0,150
20,0	20,0	4,0	-	0,100	0,167

4 flute end mill; 30° helix; DIN6527S; short length; TiAlN coated
 Schafffräser 4 Schneiden; 30° Drallwinkel; DIN6527K; kurze Ausführung; TiAlN beschichtet

Specifications / Spezifikationen

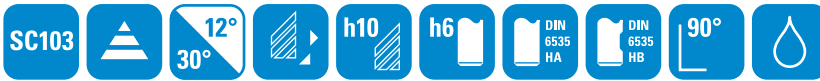

DIN 6535 HA	DIN 6535 HB	Dc	Ds	Lc	Ln	Dn	Lt	r	z
BLC4S03030S	BLW4S03030S	3,0	6	5	-	-	50	-	4
BLC4S03530S	BLW4S03530S	3,5	6	6	-	-	50	-	4
BLC4S04030S	BLW4S04030S	4,0	6	8	-	-	54	-	4
BLC4S04530S	BLW4S04530S	4,5	6	8	-	-	54	-	4
BLC4S05030S	BLW4S05030S	5,0	6	9	-	-	54	-	4
BLC4S06030S	BLW4S06030S	6,0	6	10	-	-	54	-	4
BLC4S08030S	BLW4S08030S	8,0	8	12	-	-	58	-	4
BLC4S10030S	BLW4S10030S	10,0	10	14	-	-	66	-	4
BLC4S12030S	BLW4S12030S	12,0	12	16	-	-	73	-	4
BLC4S14030S	BLW4S14030S	14,0	14	18	-	-	73	-	4
BLC4S16030S	BLW4S16030S	16,0	16	22	-	-	82	-	4
BLC4S18030S	BLW4S18030S	18,0	18	24	-	-	84	-	4
BLC4S20030S	BLW4S20030S	20,0	20	26	-	-	92	-	4



4 flute end mill; 30° helix; DIN6527L; long length; TiAlN coated

Schaftfräser 4 Schneiden; 30° Drallwinkel; DIN6527L; lange Ausführung; TiAlN beschichtet

Workpiece material groups and cutting speed / Werkstoffgruppen und Schnittgeschwindigkeiten

Material Material	Tensile strength Zugfestigkeit Rm [N/mm ²]	Hardness Härte [HB/HRC]	Cutting speed Vc [m/min] Schnittgeschwindigkeiten		
			min	opt	max
P1 Plain carbon steel / Unlegierter Stahl	< 600	< 230	120	180	220
P2 Alloy Steel / Legierter Stahl	< 1200	< 350	70	100	150
P3 High alloy steel and tool steel / Hochlegierter Stahl und Werkzeugstahl	< 1400	< 380	60	80	90
M1 Aust. and Ferr. Stainless steel / Aust. und Ferr. rostfreie Stähle	< 680	< 220	70	90	110
M2 Mart. Stainless steel / Mart. rostfreie Stähle	< 820	< 240	60	80	100
K1 Grey cast iron / Grauguß	-	< 280	100	140	160
K2 Ductile cast iron / Sphäroguß	-	< 320	80	100	120
N1 Non-ferrous alloys / Nichteisenmetalle	< 250	< 110	-	-	-
N2 Aluminium alloys / Aluminiumlegierungen	< 530	< 130	-	-	-
S1 High temperature alloys Fe, Ni and Co based / Warmfeste Leg. Fe, Ni und Co	< 3300	< 350	40	50	60
S2 Titanium alloys; Alpha and Beta / Titan Legierungen Alpha und Beta	< 2100	< 400	60	70	80
H1 Hardened steel / Gehärtete Stähle	-	< 54 HRC	-	-	-
H2 Hardened steel / Gehärtete Stähle	-	52-60 HRC	-	-	-
H3 Hardened steel / Gehärtete Stähle	-	> 58 HRC	-	-	-
G1 Graphite / Graphit	-	-	-	-	-

Cutting conditions / Zerspanungswerte

Peripheral milling / Umfangfräsen

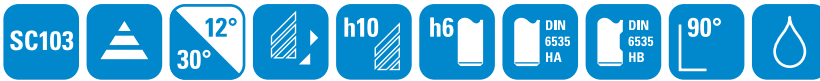

Dc	Ap [1.75xD]	Ae 1 [0.2xD]	Ae 2	fz 1 ▼▼	fz 2 ▼
3,0	5,3	0,6	-	0,010	0,015
3,5	6,1	0,7	-	0,012	0,018
4,0	7,0	0,8	-	0,013	0,020
4,5	7,9	0,9	-	0,015	0,023
5,0	8,8	1,0	-	0,017	0,025
6,0	10,5	1,2	-	0,020	0,030
8,0	14,0	1,6	-	0,027	0,040
10,0	17,5	2,0	-	0,033	0,050
12,0	21,0	2,4	-	0,040	0,060
14,0	24,5	2,8	-	0,047	0,070
16,0	28,0	3,2	-	0,053	0,080
18,0	31,5	3,6	-	0,060	0,090
20,0	35,0	4,0	-	0,067	0,100

4 flute end mill; 30° helix; DIN6527L; long length; TiAlN coated
Schaftfräser 4 Schneiden; 30° Drallwinkel; DIN6527L; lange Ausführung; TiAlN beschichtet
Specifications / Spezifikationen

DIN 6535 HA	DIN 6535 HB	Dc	Ds	Lc	Ln	Dn	Lt	r	z
BLC4L03030S	BLW4L03030S	3,0	6	8	-	-	57	-	4
BLC4L03530S	BLW4L03530S	3,5	6	10	-	-	57	-	4
BLC4L04030S	BLW4L04030S	4,0	6	11	-	-	57	-	4
BLC4L04530S	BLW4L04530S	4,5	6	11	-	-	57	-	4
BLC4L05030S	BLW4L05030S	5,0	6	13	-	-	57	-	4
BLC4L06030S	BLW4L06030S	6,0	6	13	-	-	57	-	4
BLC4L08030S	BLW4L08030S	8,0	8	19	-	-	63	-	4
BLC4L10030S	BLW4L10030S	10,0	10	22	-	-	72	-	4
BLC4L12030S	BLW4L12030S	12,0	12	26	-	-	83	-	4
BLC4L14030S	BLW4L14030S	14,0	14	26	-	-	83	-	4
BLC4L16030S	BLW4L16030S	16,0	16	32	-	-	92	-	4
BLC4L18030S	BLW4L18030S	18,0	18	32	-	-	92	-	4
BLC4L20030S	BLW4L20030S	20,0	20	38	-	-	104	-	4



Other dimensions on request / Andere Abmessungen auf Anfrage

Dimensions in mm / Maße in mm

Multi flute end mill; 45° helix; DIN6527L; long length; TiAlN coated

Schaftfräser multi Schneiden; 45° Drallwinkel; DIN6527L; lange Ausführung; TiAlN beschichtet

Workpiece material groups and cutting speed / Werkstoffgruppen und Schnittgeschwindigkeiten

Material Material	Tensile strength Zugfestigkeit Rm [N/mm ²]	Hardness Härte [HB/HRC]	Cutting speed Vc [m/min] Schnittgeschwindigkeiten		
			min	opt	max
P1 Plain carbon steel / Unlegierter Stahl	< 600	< 230	120	180	220
P2 Alloy Steel / Legierter Stahl	< 1200	< 350	70	100	150
P3 High alloy steel and tool steel / Hochlegierter Stahl und Werkzeugstahl	< 1400	< 380	60	80	90
M1 Aust. and Ferr. Stainless steel / Aust. und Ferr. rostfreie Stähle	< 680	< 220	70	90	110
M2 Mart. Stainless steel / Mart. rostfreie Stähle	< 820	< 240	60	80	100
K1 Grey cast iron / Grauguß	-	< 280	100	140	160
K2 Ductile cast iron / Sphäroguß	-	< 320	80	100	120
N1 Non-ferrous alloys / Nichteisenmetalle	< 250	< 110	-	-	-
N2 Aluminium alloys / Aluminiumlegierungen	< 530	< 130	-	-	-
S1 High temperature alloys Fe, Ni and Co based / Warmfeste Leg. Fe, Ni und Co	< 3300	< 350	40	50	60
S2 Titanium alloys; Alpha and Beta / Titan Legierungen Alpha und Beta	< 2100	< 400	60	70	80
H1 Hardened steel / Gehärtete Stähle	-	< 54 HRC	60	80	100
H2 Hardened steel / Gehärtete Stähle	-	52-60 HRC	-	-	-
H3 Hardened steel / Gehärtete Stähle	-	> 58 HRC	-	-	-
G1 Graphite / Graphit	-	-	-	-	-

Cutting conditions / Zerspanungswerte

Peripheral milling / Umfangfräsen



Dc	Ap	Ae 1	Ae 2	fz 1	fz 2
[1.75xD]	[0.05xD]	[0.025xD]		▼▼▼	▼▼
6,0	10,5	0,3	0,15	0,030	0,040
8,0	14,0	0,4	0,20	0,040	0,053
10,0	17,5	0,5	0,25	0,050	0,067
12,0	21,0	0,6	0,30	0,060	0,080
14,0	24,5	0,7	0,35	0,070	0,093
16,0	28,0	0,8	0,40	0,080	0,107
18,0	31,5	0,9	0,45	0,090	0,120
20,0	35,0	1,0	0,50	0,100	0,133

Multi flute end mill; 45° helix; DIN6527L; long length; TiAlN coated
 Schafffräser multi Schneiden; 45° Drallwinkel; DIN6527L; lange Ausführung; TiAlN beschichtet

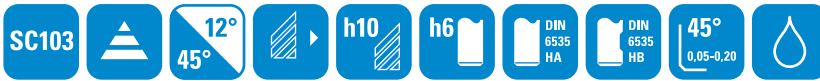
Specifications / Spezifikationen

DIN 6535 HA	DIN 6535 HB	Dc	Ds	Lc	Ln	Dn	Lt	r	z
BLC6L06045S	BLW6L06045S	6,0	6	13	-	-	57	-	6
BLC6L08045S	BLW6L08045S	8,0	8	19	-	-	63	-	6
BLC6L10045S	BLW6L10045S	10,0	10	22	-	-	72	-	6
BLC6L12045S	BLW6L12045S	12,0	12	26	-	-	83	-	6
BLC6L14045S	BLW6L14045S	14,0	14	26	-	-	83	-	6
BLC6L16045S	BLW6L16045S	16,0	16	32	-	-	92	-	6
BLC8L18045S	BLW8L18045S	18,0	18	32	-	-	92	-	8
BLC8L20045S	BLW8L20045S	20,0	20	38	-	-	104	-	8



Multi flute end mill; 45° helix; SCT norm; XL length; TiAlN coated

Schaftfräser multi Schneiden; 45° Drallwinkel; SCT Norm; XL Ausführung; TiAlN beschichtet

Workpiece material groups and cutting speed / Werkstoffgruppen und Schnittgeschwindigkeiten

Material Material	Tensile strength Zugfestigkeit Rm [N/mm ²]	Hardness Härte [HB/HRC]	Cutting speed Vc [m/min] Schnittgeschwindigkeiten		
			min	opt	max
P1 Plain carbon steel / Unlegierter Stahl	< 600	< 230	120	180	220
P2 Alloy Steel / Legierter Stahl	< 1200	< 350	70	100	150
P3 High alloy steel and tool steel / Hochlegierter Stahl und Werkzeugstahl	< 1400	< 380	60	80	90
M1 Aust. and Ferr. Stainless steel / Aust. und Ferr. rostfreie Stähle	< 680	< 220	70	90	110
M2 Mart. Stainless steel / Mart. rostfreie Stähle	< 820	< 240	60	80	100
K1 Grey cast iron / Grauguß	-	< 280	100	140	160
K2 Ductile cast iron / Sphäroguß	-	< 320	80	100	120
N1 Non-ferrous alloys / Nichteisenmetalle	< 250	< 110	-	-	-
N2 Aluminium alloys / Aluminiumlegierungen	< 530	< 130	-	-	-
S1 High temperature alloys Fe, Ni and Co based / Warmfeste Leg. Fe, Ni und Co	< 3300	< 350	40	50	60
S2 Titanium alloys; Alpha and Beta / Titan Legierungen Alpha und Beta	< 2100	< 400	60	70	80
H1 Hardened steel / Gehärtete Stähle	-	< 54 HRC	60	80	100
H2 Hardened steel / Gehärtete Stähle	-	52-60 HRC	-	-	-
H3 Hardened steel / Gehärtete Stähle	-	> 58 HRC	-	-	-
G1 Graphite / Graphit	-	-	-	-	-

Cutting conditions / Zerspanungswerte

Peripheral milling / Umfangfräsen



Dc	Ap	Ae 1	Ae 2	fz 1	fz 2
[2.75xD]	[0.05xD]	[0.025xD]		▼▼▼	▼▼
6,0	16,5	0,3	0,15	0,020	0,025
8,0	22,0	0,4	0,20	0,027	0,033
10,0	27,5	0,5	0,25	0,033	0,042
12,0	33,0	0,6	0,30	0,040	0,050
14,0	38,5	0,7	0,35	0,047	0,058
16,0	44,0	0,8	0,40	0,053	0,067
18,0	49,5	0,9	0,45	0,060	0,075
20,0	55,0	1,0	0,50	0,067	0,083

Multi flute end mill; 45° helix; SCT norm; XL length; TiAlN coated
 Schafffräser multi Schneiden; 45° Drallwinkel; SCT Norm; XL Ausführung; TiAlN beschichtet

Specifications / Spezifikationen

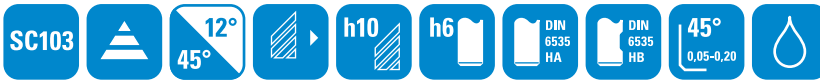

DIN 6535 HA	DIN 6535 HB	Dc	Ds	Lc	Ln	Dn	Lt	r	z
BLC6X06045S	BLW6X06045S	6,0	6	18	-	-	62	-	6
BLC6X08045S	BLW6X08045S	8,0	8	24	-	-	68	-	6
BLC6X10045S	BLW6X10045S	10,0	10	30	-	-	80	-	6
BLC6X12045S	BLW6X12045S	12,0	12	36	-	-	93	-	6
BLC6X14045S	BLW6X14045S	14,0	14	45	-	-	100	-	6
BLC6X16045S	BLW6X16045S	16,0	16	48	-	-	108	-	6
BLC8X18045S	BLW8X18045S	18,0	18	55	-	-	115	-	8
BLC8X20045S	BLW8X20045S	20,0	20	60	-	-	126	-	8



Other dimensions on request / Andere Abmessungen auf Anfrage

Dimensions in mm / Maße in mm

Multi flute end mill; 45° helix; SCT norm; XXL length; TiAlN coated

Schaftfräser multi Schneiden; 45° Drallwinkel; SCT Norm; XXL Ausführung; TiAlN beschichtet

Workpiece material groups and cutting speed / Werkstoffgruppen und Schnittgeschwindigkeiten

Material Material	Tensile strength Zugfestigkeit Rm [N/mm ²]	Hardness Härte [HB/HRC]	Cutting speed Vc [m/min] Schnittgeschwindigkeiten		
			min	opt	max
P1 Plain carbon steel / Unlegierter Stahl	< 600	< 230	120	180	220
P2 Alloy Steel / Legierter Stahl	< 1200	< 350	70	100	150
P3 High alloy steel and tool steel / Hochlegierter Stahl und Werkzeugstahl	< 1400	< 380	60	80	90
M1 Aust. and Ferr. Stainless steel / Aust. und Ferr. rostfreie Stähle	< 680	< 220	70	90	110
M2 Mart. Stainless steel / Mart. rostfreie Stähle	< 820	< 240	60	80	100
K1 Grey cast iron / Grauguß	-	< 280	100	140	160
K2 Ductile cast iron / Sphäroguß	-	< 320	80	100	120
N1 Non-ferrous alloys / Nichteisenmetalle	< 250	< 110	-	-	-
N2 Aluminium alloys / Aluminiumlegierungen	< 530	< 130	-	-	-
S1 High temperature alloys Fe, Ni and Co based / Warmfeste Leg. Fe, Ni und Co	< 3300	< 350	40	50	60
S2 Titanium alloys; Alpha and Beta / Titan Legierungen Alpha und Beta	< 2100	< 400	60	70	80
H1 Hardened steel / Gehärtete Stähle	-	< 54 HRC	60	80	100
H2 Hardened steel / Gehärtete Stähle	-	52-60 HRC	-	-	-
H3 Hardened steel / Gehärtete Stähle	-	> 58 HRC	-	-	-
G1 Graphite / Graphit	-	-	-	-	-

Cutting conditions / Zerspanungswerte

Peripheral milling / Umfangfräsen



Dc	Ap	Ae 1	Ae 2	fz 1	fz 2
	[3.5xD]	[0.05xD]	[0.025xD]	▼▼	▼
6,0	21,0	0,3	0,15	0,020	0,025
8,0	28,0	0,4	0,20	0,027	0,033
10,0	35,0	0,5	0,25	0,033	0,042
12,0	42,0	0,6	0,30	0,040	0,050
16,0	56,0	0,8	0,40	0,053	0,063
20,0	70,0	1,0	0,50	0,067	0,083

Multi flute end mill; 45° helix; SCT norm; XXL length; TiAlN coated
 Schafffräser multi Schneiden; 45° Drallwinkel; SCT Norm; XXL Ausführung; TiAlN beschichtet

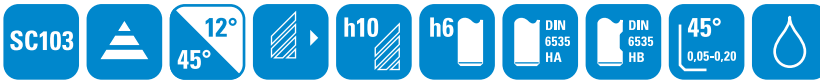
Specifications / Spezifikationen

DIN 6535 HA	DIN 6535 HB	Dc	Ds	Lc	Ln	Dn	Lt	r	z
BLC6X06045X	BLW6X06045X	6,0	6	36	-	-	80	-	6
BLC6X08045X	BLW6X08045X	8,0	8	46	-	-	90	-	6
BLC6X10045X	BLW6X10045X	10,0	10	50	-	-	100	-	6
BLC6X12045X	BLW6X12045X	12,0	12	65	-	-	120	-	6
BLC6X16045X	BLW6X16045X	16,0	16	80	-	-	140	-	6
BLC8X20045X	BLW8X20045X	20,0	20	94	-	-	160	-	8



Other dimensions on request / Andere Abmessungen auf Anfrage

Dimensions in mm / Maße in mm

4 flute end mill; 35°-38° helix; DIN6527L; long length; TiAlN coated

Schafffräser 4 Schneiden; 35°-38° Drallwinkel; DIN6527L; lange Ausführung; TiAlN beschichtet

Workpiece material groups and cutting speed / Werkstoffgruppen und Schnittgeschwindigkeiten

Material Material	Tensile strength Zugfestigkeit Rm [N/mm ²]	Hardness Härte [HB/HRC]	Cutting speed Vc [m/min] Schnittgeschwindigkeiten		
			min	opt	max
P1 Plain carbon steel / Unlegierter Stahl	< 600	< 230	120	180	220
P2 Alloy Steel / Legierter Stahl	< 1200	< 350	70	100	150
P3 High alloy steel and tool steel / Hochlegierter Stahl und Werkzeugstahl	< 1400	< 380	60	80	90
M1 Aust. and Ferr. Stainless steel / Aust. und Ferr. rostfreie Stähle	< 680	< 220	70	90	110
M2 Mart. Stainless steel / Mart. rostfreie Stähle	< 820	< 240	60	80	100
K1 Grey cast iron / Grauguß	-	< 280	100	140	160
K2 Ductile cast iron / Sphäroguß	-	< 320	80	100	120
N1 Non-ferrous alloys / Nichteisenmetalle	< 250	< 110	-	-	-
N2 Aluminium alloys / Aluminiumlegierungen	< 530	< 130	-	-	-
S1 High temperature alloys Fe, Ni and Co based / Warmfeste Leg. Fe, Ni und Co	< 3300	< 350	40	50	60
S2 Titanium alloys; Alpha and Beta / Titan Legierungen Alpha und Beta	< 2100	< 400	60	70	80
H1 Hardened steel / Gehärtete Stähle	-	< 54 HRC	40	60	80
H2 Hardened steel / Gehärtete Stähle	-	52-60 HRC	-	-	-
H3 Hardened steel / Gehärtete Stähle	-	> 58 HRC	-	-	-
G1 Graphite / Graphit	-	-	-	-	-

Cutting conditions / Zerspanungswerte

Peripheral milling / Umfangfräsen



Dc	Ap [1.5xD]	Ae 1 [0.3xD]	Ae 2	fz 1 ▼▼	fz 2 ▼
3,0	4,5	0,9	-	0,012	0,025
3,5	5,3	1,1	-	0,014	0,029
4,0	6,0	1,2	-	0,016	0,033
4,5	6,8	1,4	-	0,018	0,037
5,0	7,5	1,5	-	0,020	0,042
6,0	9,0	1,8	-	0,024	0,050
8,0	12,0	2,4	-	0,032	0,067
10,0	15,0	3,0	-	0,040	0,083
12,0	18,0	3,6	-	0,048	0,100
14,0	21,0	4,2	-	0,056	0,117
16,0	24,0	4,8	-	0,064	0,133
18,0	27,0	5,4	-	0,072	0,150
20,0	30,0	6,0	-	0,080	0,167

Slot milling / Vollnutfräsen



Dc	Ap [1xD]	Ae [1xD]	fz
3,0	3,0	3,0	0,012
3,5	3,5	3,5	0,014
4,0	4,0	4,0	0,016
4,5	4,5	4,5	0,018
5,0	5,0	5,0	0,020
6,0	6,0	6,0	0,024
8,0	8,0	8,0	0,032
10,0	10,0	10,0	0,040
12,0	12,0	12,0	0,048
14,0	14,0	14,0	0,056
16,0	16,0	16,0	0,064
18,0	18,0	18,0	0,072
20,0	20,0	20,0	0,080

4 flute end mill; 35°-38° helix; DIN6527L; long length; TiAlN coated
 Schafffräser 4 Schneiden; 35°-38° Drallwinkel; DIN6527L; lange Ausführung; TiAlN beschichtet

Specifications / Spezifikationen

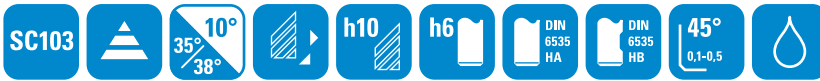

DIN 6535 HA	DIN 6535 HB	Dc	Ds	Lc	Ln	Dn	Lt	r	z
BLC4L03038V	BLW4L03038V	3,0	6	8	-	-	57	-	4
BLC4L03538V	BLW4L03538V	3,5	6	10	-	-	57	-	4
BLC4L04038V	BLW4L04038V	4,0	6	11	-	-	57	-	4
BLC4L04538V	BLW4L04538V	4,5	6	11	-	-	57	-	4
BLC4L05038V	BLW4L05038V	5,0	6	13	-	-	57	-	4
BLC4L06038V	BLW4L06038V	6,0	6	13	-	-	57	-	4
BLC4L08038V	BLW4L08038V	8,0	8	19	-	-	63	-	4
BLC4L10038V	BLW4L10038V	10,0	10	22	-	-	72	-	4
BLC4L12038V	BLW4L12038V	12,0	12	26	-	-	83	-	4
BLC4L14038V	BLW4L14038V	14,0	14	26	-	-	83	-	4
BLC4L16038V	BLW4L16038V	16,0	16	32	-	-	92	-	4
BLC4L18038V	BLW4L18038V	18,0	18	32	-	-	92	-	4
BLC4L20038V	BLW4L20038V	20,0	20	38	-	-	104	-	4



Semi-Rougher; 45° helix; DIN6527L; long length; TiAlN coated

Schrupp / Schlichtfräser; 45° Drallwinkel; DIN6527L; lange Ausführung; TiAlN beschichtet

Workpiece material groups and cutting speed / Werkstoffgruppen und Schnittgeschwindigkeiten

Material Material	Tensile strength Zugfestigkeit Rm [N/mm ²]	Hardness Härte [HB/HRC]	Cutting speed Vc [m/min] Schnittgeschwindigkeiten		
			min	opt	max
P1 Plain carbon steel / Unlegierter Stahl	< 600	< 230	120	180	220
P2 Alloy Steel / Legierter Stahl	< 1200	< 350	70	100	150
P3 High alloy steel and tool steel / Hochlegierter Stahl und Werkzeugstahl	< 1400	< 380	60	80	90
M1 Aust. and Ferr. Stainless steel / Aust. und Ferr. rostfreie Stähle	< 680	< 220	70	90	110
M2 Mart. Stainless steel / Mart. rostfreie Stähle	< 820	< 240	60	80	100
K1 Grey cast iron / Grauguß	-	< 280	100	140	160
K2 Ductile cast iron / Sphäroguß	-	< 320	80	100	120
N1 Non-ferrous alloys / Nichteisenmetalle	< 250	< 110	-	-	-
N2 Aluminium alloys / Aluminiumlegierungen	< 530	< 130	-	-	-
S1 High temperature alloys Fe, Ni and Co based / Warmfeste Leg. Fe, Ni und Co	< 3300	< 350	40	50	60
S2 Titanium alloys; Alpha and Beta / Titan Legierungen Alpha und Beta	< 2100	< 400	60	70	80
H1 Hardened steel / Gehärtete Stähle	-	< 54 HRC	-	-	-
H2 Hardened steel / Gehärtete Stähle	-	52-60 HRC	-	-	-
H3 Hardened steel / Gehärtete Stähle	-	> 58 HRC	-	-	-
G1 Graphite / Graphit	-	-	-	-	-

Cutting conditions / Zerspanungswerte

Peripheral milling / Umfangfräsen



Dc	Ap [1.75xD]	Ae 1 [0.3xD]	Ae 2	fz 1 ▼▼	fz 2 ▼
4,0	7,0	1,2	-	0,010	0,015
5,0	8,8	1,5	-	0,013	0,019
6,0	10,5	1,8	-	0,015	0,023
8,0	14,0	2,4	-	0,020	0,030
10,0	17,5	3,0	-	0,025	0,038
12,0	21,0	3,6	-	0,030	0,045
14,0	24,5	4,2	-	0,035	0,053
16,0	28,0	4,8	-	0,040	0,060
18,0	31,5	5,4	-	0,045	0,068
20,0	35,0	6,0	-	0,050	0,075

Slot milling / Vollnutfräsen



Dc	Ap [0.5xD]	Ae [1xD]	fz
4,0	2,0	4,0	0,015
5,0	2,5	5,0	0,019
6,0	3,0	6,0	0,023
8,0	4,0	8,0	0,030
10,0	5,0	10,0	0,038
12,0	6,0	12,0	0,045
14,0	7,0	14,0	0,053
16,0	8,0	16,0	0,060
18,0	9,0	18,0	0,068
20,0	10,0	20,0	0,075

Semi-Rougher; 45° helix; DIN6527L; long length; TiAlN coated

Schrupp / Schlichtfräser; 45° Drallwinkel; DIN6527L; lange Ausführung; TiAlN beschichtet

Specifications / Spezifikationen

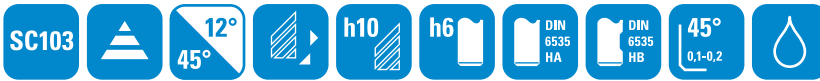

DIN 6535 HA	DIN 6535 HB	Dc	Ds	Lc	Ln	Dn	Lt	r	z
BLC4L04045U	BLW4L04045U	4,0	6	11	-	-	57	-	4
BLC4L05045U	BLW4L05045U	5,0	6	13	-	-	57	-	4
BLC4L06045U	BLW4L06045U	6,0	6	13	-	-	57	-	4
BLC4L08045U	BLW4L08045U	8,0	8	19	-	-	63	-	4
BLC4L10045U	BLW4L10045U	10,0	10	22	-	-	72	-	4
BLC4L12045U	BLW4L12045U	12,0	12	26	-	-	83	-	4
BLC4L14045U	BLW4L14045U	14,0	14	26	-	-	83	-	4
BLC4L16045U	BLW4L16045U	16,0	16	32	-	-	92	-	4
BLC4L18045U	BLW4L18045U	18,0	18	32	-	-	92	-	4
BLC4L20045U	BLW4L20045U	20,0	20	38	-	-	104	-	4



Multi flute rougher; 20° helix; DIN6527L; long length; TiAlN coated

Schruppfräser multi Schneiden; 20° Drallwinkel; DIN6527L; lange Ausführung; TiAlN beschichtet

Workpiece material groups and cutting speed / Werkstoffgruppen und Schnittgeschwindigkeiten

Material Material	Tensile strength Zugfestigkeit Rm [N/mm ²]	Hardness Härte [HB/HRC]	Cutting speed Vc [m/min] Schnittgeschwindigkeiten		
			min	opt	max
P1 Plain carbon steel / Unlegierter Stahl	< 600	< 230	120	180	220
P2 Alloy Steel / Legierter Stahl	< 1200	< 350	70	100	150
P3 High alloy steel and tool steel / Hochlegierter Stahl und Werkzeugstahl	< 1400	< 380	60	80	90
M1 Aust. and Ferr. Stainless steel / Aust. und Ferr. rostfreie Stähle	< 680	< 220	-	-	-
M2 Mart. Stainless steel / Mart. rostfreie Stähle	< 820	< 240	-	-	-
K1 Grey cast iron / Grauguß	-	< 280	100	140	160
K2 Ductile cast iron / Sphäroguß	-	< 320	80	100	120
N1 Non-ferrous alloys / Nichteisenmetalle	< 250	< 110	-	-	-
N2 Aluminium alloys / Aluminiumlegierungen	< 530	< 130	-	-	-
S1 High temperature alloys Fe, Ni and Co based / Warmfeste Leg. Fe, Ni und Co	< 3300	< 350	40	50	60
S2 Titanium alloys; Alpha and Beta / Titan Legierungen Alpha und Beta	< 2100	< 400	60	70	80
H1 Hardened steel / Gehärtete Stähle	-	< 54 HRC	-	-	-
H2 Hardened steel / Gehärtete Stähle	-	52-60 HRC	-	-	-
H3 Hardened steel / Gehärtete Stähle	-	> 58 HRC	-	-	-
G1 Graphite / Graphit	-	-	-	-	-

Cutting conditions / Zerspanungswerte

Peripheral milling / Umfangfräsen



Dc	Ap [1xD]	Ae 1 [0.4xD]	Ae 2	fz 1 ▼▼	fz 2 ▼
6,0	6,0	2,4	-	0,015	0,025
8,0	8,0	3,2	-	0,020	0,033
10,0	10,0	4,0	-	0,025	0,042
12,0	12,0	4,8	-	0,030	0,050
14,0	14,0	5,6	-	0,035	0,058
16,0	16,0	6,4	-	0,040	0,067
18,0	18,0	7,2	-	0,045	0,075
20,0	20,0	8,0	-	0,050	0,083

Slot milling / Vollnutfräsen



Dc	Ap [0.75xD]	Ae [1xD]	fz
6,0	4,5	6,0	0,010
8,0	6,0	8,0	0,013
10,0	7,5	10,0	0,017
12,0	9,0	12,0	0,020
14,0	10,5	14,0	0,023
16,0	12,0	16,0	0,027
18,0	13,5	18,0	0,030
20,0	15,0	20,0	0,033

Multi flute rougher; 20° helix; DIN6527L; long length; TiAlN coated
 Schruppfräser multi Schneiden; 20° Drallwinkel; DIN6527L; lange Ausführung; TiAlN beschichtet

Specifications / Spezifikationen

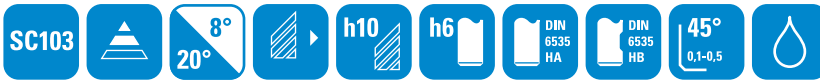

DIN 6535 HA	DIN 6535 HB	Dc	Ds	Lc	Ln	Dn	Lt	r	z
BLC3L06020R	BLW3L06020R	6,0	6	13	-	-	57	-	3
BLC3L08020R	BLW3L08020R	8,0	8	19	-	-	63	-	3
BLC4L10020R	BLW4L10020R	10,0	10	22	-	-	72	-	4
BLC4L12020R	BLW4L12020R	12,0	12	26	-	-	83	-	4
BLC4L14020R	BLW4L14020R	14,0	14	26	-	-	83	-	4
BLC4L16020R	BLW4L16020R	16,0	16	32	-	-	92	-	4
BLC4L18020R	BLW4L18020R	18,0	18	32	-	-	92	-	4
BLC4L20020R	BLW4L20020R	20,0	20	38	-	-	104	-	4



Other dimensions on request / Andere Abmessungen auf Anfrage

Dimensions in mm / Maße in mm

Multi flute rougher; 45° helix; DIN6527L; long length; TiAlN coated

Schruppfräser multi Schneiden; 45° Drallwinkel; DIN6527L; lange Ausführung; TiAlN beschichtet

Workpiece material groups and cutting speed / Werkstoffgruppen und Schnittgeschwindigkeiten

Material Material	Tensile strength Zugfestigkeit Rm [N/mm ²]	Hardness Härte [HB/HRC]	Cutting speed Vc [m/min] Schnittgeschwindigkeiten		
			min	opt	max
P1 Plain carbon steel / Unlegierter Stahl	< 600	< 230	120	180	220
P2 Alloy Steel / Legierter Stahl	< 1200	< 350	70	100	150
P3 High alloy steel and tool steel / Hochlegierter Stahl und Werkzeugstahl	< 1400	< 380	60	80	90
M1 Aust. and Ferr. Stainless steel / Aust. und Ferr. rostfreie Stähle	< 680	< 220	70	90	110
M2 Mart. Stainless steel / Mart. rostfreie Stähle	< 820	< 240	60	80	100
K1 Grey cast iron / Grauguß	-	< 280	100	140	160
K2 Ductile cast iron / Sphäroguß	-	< 320	80	100	120
N1 Non-ferrous alloys / Nichteisenmetalle	< 250	< 110	-	-	-
N2 Aluminium alloys / Aluminiumlegierungen	< 530	< 130	-	-	-
S1 High temperature alloys Fe, Ni and Co based / Warmfeste Leg. Fe, Ni und Co	< 3300	< 350	40	50	60
S2 Titanium alloys; Alpha and Beta / Titan Legierungen Alpha und Beta	< 2100	< 400	60	70	80
H1 Hardened steel / Gehärtete Stähle	-	< 54 HRC	-	-	-
H2 Hardened steel / Gehärtete Stähle	-	52-60 HRC	-	-	-
H3 Hardened steel / Gehärtete Stähle	-	> 58 HRC	-	-	-
G1 Graphite / Graphit	-	-	-	-	-

Cutting conditions / Zerspanungswerte

Peripheral milling / Umfangfräsen



Dc	Ap [1.5xD]	Ae 1 [0.4xD]	Ae 2	fz 1 ▼▼	fz 2 ▼
4,0	6,0	1,6	-	0,010	0,025
5,0	7,5	2,0	-	0,013	0,031
6,0	9,0	2,4	-	0,015	0,038
8,0	12,0	3,2	-	0,020	0,050
10,0	15,0	4,0	-	0,025	0,063
12,0	18,0	4,8	-	0,030	0,075
14,0	21,0	5,6	-	0,035	0,088
16,0	24,0	6,4	-	0,040	0,100
16,0	24,0	6,4	-	0,040	0,100
18,0	27,0	7,2	-	0,045	0,113
20,0	30,0	8,0	-	0,050	0,125
20,0	30,0	8,0	-	0,050	0,125

Slot milling / Vollnutfräsen



Dc	Ap [1xD]	Ae [1xD]	fz
4,0	4	4	0,015
5,0	5	5	0,019
6,0	6	6	0,023
8,0	8	8	0,030
10,0	10	10	0,038
12,0	12	12	0,045
14,0	14	14	0,053
14,0	14	14	0,053
16,0	16	16	0,060
18,0	18	18	0,068
14,0	14	14	0,053
20,0	20	20	0,075

Multi flute rougher; 45° helix; DIN6527L; long length; TiAlN coated
 Schruppfräser multi Schneiden; 45° Drallwinkel; DIN6527L; lange Ausführung; TiAlN beschichtet

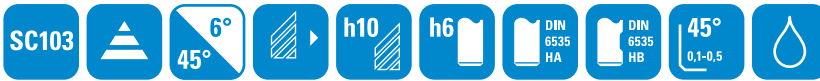
Specifications / Spezifikationen

DIN 6535 HA	DIN 6535 HB	Dc	Ds	Lc	Ln	Dn	Lt	r	z
BLC3L04045R	BLW3L04045R	4,0	6	11	-	-	57	-	3
BLC4L05045R	BLW4L05045R	5,0	6	13	-	-	57	-	4
BLC4L06045R	BLW4L06045R	6,0	6	13	-	-	57	-	4
BLC4L08045R	BLW4L08045R	8,0	8	19	-	-	63	-	4
BLC4L10045R	BLW4L10045R	10,0	10	22	-	-	72	-	4
BLC4L12045R	BLW4L12045R	12,0	12	26	-	-	83	-	4
BLC4L14045R	BLW4L14045R	14,0	14	26	-	-	83	-	4
BLC4L16045R	BLW4L16045R	16,0	16	32	-	-	92	-	4
BLC5L16045R	BLW5L16045R	16,0	16	32	-	-	92	-	5
BLC5L18045R	BLW5L18045R	18,0	18	32	-	-	92	-	5
BLC5L20045R	BLW5L20045R	20,0	20	38	-	-	104	-	5
BLC6L20045R	BLW6L20045R	20,0	20	38	-	-	104	-	6



2 flute ball nose; 30° helix; DIN6527S; short length; TiAlN coated

Radiusfräser 2 Schneiden; 30° Drallwinkel; DIN6527K; kurze Ausführung; TiAlN beschichtet

Workpiece material groups and cutting speed / Werkstoffgruppen und Schnittgeschwindigkeiten

Material Material	Tensile strength Zugfestigkeit Rm [N/mm ²]	Hardness Härte [HB/HRC]	Cutting speed Vc [m/min] Schnittgeschwindigkeiten	
			[Eff]	[Prog]
P1 Plain carbon steel / Unlegierter Stahl	< 600	< 230	140 - 250	280 - 500
P2 Alloy Steel / Legierter Stahl	< 1200	< 350	75 - 180	150 - 360
P3 High alloy steel and tool steel / Hochlegierter Stahl und Werkzeugstahl	< 1400	< 380	60 - 120	120 - 240
M1 Aust. and Ferr. Stainless steel / Aust. und Ferr. rostfreie Stähle	< 680	< 220	70 - 110	140 - 220
M2 Mart. Stainless steel / Mart. rostfreie Stähle	< 820	< 240	60 - 100	120 - 220
K1 Grey cast iron / Grauguß	-	< 280	120 - 180	240 - 360
K2 Ductile cast iron / Sphäroguß	-	< 320	100 - 140	200 - 280
N1 Non-ferrous alloys / Nichteisenmetalle	< 250	< 110	120 - 350	240 - 700
N2 Aluminium alloys / Aluminiumlegierungen	< 530	< 130	150 - 450	300 - 900
S1 High temperature alloys Fe, Ni and Co based / Warmfeste Leg. Fe, Ni und Co	< 3300	< 350	-	-
S2 Titanium alloys; Alpha and Beta / Titan Legierungen Alpha und Beta	< 2100	< 400	-	-
H1 Hardened steel / Gehärtete Stähle	-	< 54 HRC	40 - 80	80 - 160
H2 Hardened steel / Gehärtete Stähle	-	52-60 HRC	-	-
H3 Hardened steel / Gehärtete Stähle	-	> 58 HRC	-	-
G1 Graphite / Graphit	-	-	-	-

Cutting conditions / Zerspanungswerte

3D Milling / 3D-Fräsen



Dc	Ap	Ae 1	Ae 2	fz 1	fz 2
	[0.025xD]	[0.05xD]			
3,0	0,08	0,15	-	0,050	-
4,0	0,10	0,20	-	0,067	-
5,0	0,13	0,26	-	0,083	-
6,0	0,15	0,30	-	0,100	-
8,0	0,20	0,40	-	0,133	-
10,0	0,25	0,50	-	0,167	-
12,0	0,30	0,60	-	0,200	-
14,0	0,35	0,70	-	0,233	-
16,0	0,40	0,80	-	0,267	-
18,0	0,45	0,90	-	0,300	-
20,0	0,50	1,00	-	0,333	-

2 flute ball nose; 30° helix; DIN6527S; short length; TiAlN coated
 Radiusfräser 2 Schneiden; 30° Drallwinkel; DIN6527K; kurze Ausführung; TiAlN beschichtet

Specifications / Spezifikationen

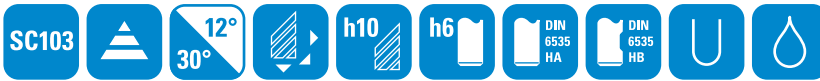

DIN 6535 HA	DIN 6535 HB	Dc	Ds	Lc	Ln	Dn	Lt	r	z
BLC2S03030B	BLW2S03030B	3,0	6	4	-	-	50	1,5	2
BLC2S04030B	BLW2S04030B	4,0	6	5	-	-	54	2,0	2
BLC2S05030B	BLW2S05030B	5,0	6	6	-	-	54	2,5	2
BLC2S06030B	BLW2S06030B	6,0	6	7	-	-	54	3,0	2
BLC2S08030B	BLW2S08030B	8,0	8	9	-	-	58	4,0	2
BLC2S10030B	BLW2S10030B	10,0	10	11	-	-	66	5,0	2
BLC2S12030B	BLW2S12030B	12,0	12	12	-	-	73	6,0	2
BLC2S14030B	BLW2S14030B	14,0	14	14	-	-	73	7,0	2
BLC2S16030B	BLW2S16030B	16,0	16	16	-	-	82	8,0	2
BLC2S18030B	BLW2S18030B	18,0	18	18	-	-	84	9,0	2
BLC2S20030B	BLW2S20030B	20,0	20	20	-	-	92	10,0	2



2 flute ball nose; 30° helix; DIN6527L; long length; TiAlN coated

Radiusfräser 2 Schneiden; 30° Drallwinkel; DIN6527L; lange Ausführung; TiAlN beschichtet

Workpiece material groups and cutting speed / Werkstoffgruppen und Schnittgeschwindigkeiten

Material Material	Tensile strength Zugfestigkeit Rm [N/mm ²]	Hardness Härte [HB/HRC]	Cutting speed Vc [m/min] Schnittgeschwindigkeiten	
			[Eff]	[Prog]
P1 Plain carbon steel / Unlegierter Stahl	< 600	< 230	140 - 250	280 - 500
P2 Alloy Steel / Legierter Stahl	< 1200	< 350	75 - 180	150 - 360
P3 High alloy steel and tool steel / Hochlegierter Stahl und Werkzeugstahl	< 1400	< 380	60 - 120	120 - 240
M1 Aust. and Ferr. Stainless steel / Aust. und Ferr. rostfreie Stähle	< 680	< 220	70 - 110	140 - 220
M2 Mart. Stainless steel / Mart. rostfreie Stähle	< 820	< 240	60 - 100	120 - 220
K1 Grey cast iron / Grauguß	-	< 280	120 - 180	240 - 360
K2 Ductile cast iron / Sphäroguß	-	< 320	100 - 140	200 - 280
N1 Non-ferrous alloys / Nichteisenmetalle	< 250	< 110	120 - 350	240 - 700
N2 Aluminium alloys / Aluminiumlegierungen	< 530	< 130	150 - 450	300 - 900
S1 High temperature alloys Fe, Ni and Co based / Warmfeste Leg. Fe, Ni und Co	< 3300	< 350	-	-
S2 Titanium alloys; Alpha and Beta / Titan Legierungen Alpha und Beta	< 2100	< 400	-	-
H1 Hardened steel / Gehärtete Stähle	-	< 54 HRC	40 - 80	80 - 160
H2 Hardened steel / Gehärtete Stähle	-	52-60 HRC	-	-
H3 Hardened steel / Gehärtete Stähle	-	> 58 HRC	-	-
G1 Graphite / Graphit	-	-	-	-

Cutting conditions / Zerspanungswerte

3D Milling / 3D-Fräsen



Dc	Ap	Ae 1	Ae 2	fz 1	fz 2
	[0.025xD]	[0.05xD]			
3,0	0,08	0,15	-	0,045	-
4,0	0,10	0,20	-	0,060	-
5,0	0,13	0,26	-	0,075	-
6,0	0,15	0,30	-	0,090	-
8,0	0,20	0,40	-	0,120	-
10,0	0,25	0,50	-	0,150	-
12,0	0,30	0,60	-	0,180	-
14,0	0,35	0,70	-	0,210	-
16,0	0,40	0,80	-	0,240	-
18,0	0,45	0,90	-	0,270	-
20,0	0,50	1,00	-	0,300	-

2 flute ball nose; 30° helix; DIN6527L; long length; TiAlN coated
 Radiusfräser 2 Schneiden; 30° Drallwinkel; DIN6527L; lange Ausführung; TiAlN beschichtet

Specifications / Spezifikationen

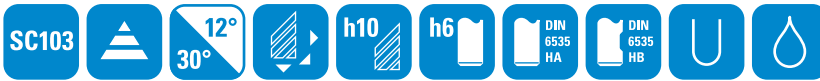

DIN 6535 HA	DIN 6535 HB	Dc	Ds	Lc	Ln	Dn	Lt	r	z
BLC2L03030B	BLW2L03030B	3,0	6	7	-	-	57	1,5	2
BLC2L04030B	BLW2L04030B	4,0	6	8	-	-	57	2,0	2
BLC2L05030B	BLW2L05030B	5,0	6	10	-	-	57	2,5	2
BLC2L06030B	BLW2L06030B	6,0	6	10	-	-	57	3,0	2
BLC2L08030B	BLW2L08030B	8,0	8	16	-	-	63	4,0	2
BLC2L10030B	BLW2L10030B	10,0	10	19	-	-	72	5,0	2
BLC2L12030B	BLW2L12030B	12,0	12	22	-	-	83	6,0	2
BLC2L14030B	BLW2L14030B	14,0	14	22	-	-	83	7,0	2
BLC2L16030B	BLW2L16030B	16,0	16	26	-	-	92	8,0	2
BLC2L18030B	BLW2L18030B	18,0	18	26	-	-	92	9,0	2
BLC2L20030B	BLW2L20030B	20,0	20	32	-	-	104	10,0	2



4 flute chamfer end mill 90°; 0° helix; SCT norm; long length; TiAlN coated
 Entgratfräser 4 Schneiden 90°; 0° Drallwinkel; SCT Norm; lange Ausführung; TiAlN beschichtet

Specifications / Spezifikationen



DIN 6535 HA	DIN 6535 HB	Dc	Ds	Lc	Ln	Dn	Lt	r	z
BLC4L060A90	-	1,2	6	-	-	-	57	-	4
BLC4L080A90	-	1,6	8	-	-	-	63	-	4
BLC4L100A90	-	2,0	10	-	-	-	72	-	4
BLC4L120A90	-	2,4	12	-	-	-	83	-	4



Other dimensions on request / Andere Abmessungen auf Anfrage

Dimensions in mm / Maße in mm

4 flute chamfer end mill 60°; 0° helix; SCT norm; long length; TiAlN coated
 Entgratfräser 4 Schneiden 60°; 0° Drallwinkel; SCT Norm; lange Ausführung; TiAlN beschichtet

Specifications / Spezifikationen



DIN 6535 HA	DIN 6535 HB	Dc	Ds	Lc	Ln	Dn	Lt	r	z
BLC4L060A60	-	1,2	6	-	-	-	57	-	4
BLC4L080A60	-	1,6	8	-	-	-	63	-	4
BLC4L100A60	-	2,0	10	-	-	-	72	-	4
BLC4L120A60	-	2,4	12	-	-	-	83	-	4



Other dimensions on request / Andere Abmessungen auf Anfrage

Dimensions in mm / Maße in mm

4 flute chamfer end mill radius; 0° helix; SCT norm; long length; TiAlN coated
 Viertelkreisfräser 4 Schneiden; 0° Drallwinkel; SCT Norm; lange Ausführung; TiAlN beschichtet

Specifications / Spezifikationen



DIN 6535 HA	DIN 6535 HB	Dc	Ds	Lc	Ln	Dn	Lt	r	z
BLC4L060C05	-	5,0	6	-	-	-	57	0,5	4
BLC4L060C10	-	4,0	6	-	-	-	57	1,0	4
BLC4L080C15	-	5,0	8	-	-	-	63	1,5	4
BLC4L080C20	-	4,0	8	-	-	-	63	2,0	4
BLC4L100C25	-	5,0	10	-	-	-	72	2,5	4
BLC4L100C30	-	4,0	10	-	-	-	72	3,0	4
BLC4L120C35	-	5,0	12	-	-	-	83	3,5	4
BLC4L120C40	-	4,0	12	-	-	-	83	4,0	4
BLC4L140C50	-	4,0	14	-	-	-	83	5,0	4





BASIC LINE
SOLID CARBIDE END MILLS®



Improving Quality Through Innovation

Product of Holland

UK D



- ▶ Improved Basic Line tools / Weiter entwickelte Basic Line Werkzeuge
- ▶ Unequal helix (including corner radius) / Ungleiche Teilungen und Winkel (einschließlich Eckenradius)
- ▶ Longer tool life / Höhere Standzeiten
- ▶ Steel (<58 HRC) and stainless steel / titanium / Stahl (<58 HRC) und NE-Metalle / Titan
- ▶ Advanced coatings / Erweiterte Beschichtungen















Improving Quality Through Innovation

Product of Holland



Table of contents

Inhaltsverzeichnis

4 flute end mill; 35°-38° helix; DIN6527S; short length; AlCrN coated Schaftfräser 4 Schneiden; 35°-38° Drallwinkel; DIN6527K; kurze Ausführung; AlCrN beschichtet	4 - 5	
4 flute end mill; 35°-38° helix; DIN6527L; long length; AlCrN coated Schaftfräser 4 Schneiden; 35°-38° Drallwinkel; DIN6527L; lange Ausführung; AlCrN beschichtet	6 - 7	
4 flute torical end mill; 35°-38° helix; DIN6527L; long length; AlCrN coated Torusfräser 4 Schneiden; 35°-38° Drallwinkel; DIN6527L; lange Ausführung; AlCrN beschichtet	8 - 9	
4 flute end mill; 36°-38° helix; DIN6527L; long length; AlTiN coated Schaftfräser 4 Schneiden; 36°-38° Drallwinkel; DIN6527L; lange Ausführung; AlTiN beschichtet	12 - 13	
5 flute end mill; 37°-38° helix; SCT norm; XL length; AlCrN coated Schaftfräser 5 Schneiden; 37°-38° Drallwinkel; SCT Norm; XL Ausführung; AlCrN beschichtet	16 - 17	
5 flute torical end mill; 37°-38° helix; SCT norm; XL length; AlCrN coated Torusfräser 5 Schneiden; 37°-38° Drallwinkel; SCT Norm; XL Ausführung; AlCrN beschichtet	18 - 19	
5 flute end mill; 41°-42° helix; SCT norm; XL length; AlCr-based coated Schaftfräser 5 Schneiden; 41°-42° Drallwinkel; SCT Norm; XL Ausführung; AlCr-basierte Schicht	20 - 21	
5 flute torical end mill; 41°-42° helix; SCT norm; XL length; AlCr-based coated Torusfräser 5 Schneiden; 41°-42° Drallwinkel; SCT Norm; XL Ausführung; AlCr-basierte Schicht	22 - 23	
Multi flute rougher; 45° helix; DIN6527S; short length; AlCrN coated Schrappfräser multi Schneiden; 45° Drallwinkel; DIN6527K; kurze Ausführung; AlCrN beschichtet	24 - 25	
Multi flute rougher; 45° helix; DIN6527L; long length; AlCrN coated Schrappfräser multi Schneiden; 45° Drallwinkel; DIN6527L; lange Ausführung; AlCrN beschichtet	26 - 27	
Multi flute end mill; 45° helix; DIN6527L; long length; AlCrN coated Schaftfräser multi Schneiden; 45° Drallwinkel; DIN6527L; lange Ausführung; AlCrN beschichtet	28 - 29	
4 flute end mill; 40°-42° helix; DIN6527L; long length; AlCrN-based coated Schaftfräser 4 Schneiden; 40°-42° Drallwinkel; DIN6527L; lange Ausführung; AlCrN-basierte Schicht	30 - 31	
4 flute torical end mill; 40°-42° helix; DIN6527L; long length; AlCr-based coated Torusfräser 4 Schneiden; 40°-42° Drallwinkel; DIN6527L; lange Ausführung; AlCr-basierte Schicht	32 - 33 NEW / NEU	

4 flute end mill; 35°-38° helix; DIN6527S; short length; AlCrN coated

Schaftfräser 4 Schneiden; 35°-38° Drallwinkel; DIN6527K; kurze Ausführung; AlCrN beschichtet

Workpiece material groups and cutting speed / Werkstoffgruppen und Schnittgeschwindigkeiten

Material Material	Tensile strength Zugfestigkeit Rm [N/mm ²]	Hardness Härte [HB/HRC]	Cutting speed Vc [m/min] Schnittgeschwindigkeiten		
			min	opt	max
P1 Plain carbon steel / Unlegierter Stahl	< 600	< 230	180	210	240
P2 Alloy Steel / Legierter Stahl	< 1200	< 350	150	175	200
P3 High alloy steel and tool steel / Hochlegierter Stahl und Werkzeugstahl	< 1400	< 380	100	120	140
M1 Aust. and Ferr. Stainless steel / Aust. und Ferr. rostfreie Stähle	< 680	< 220	80	110	140
M2 Mart. Stainless steel / Mart. rostfreie Stähle	< 820	< 240	60	90	120
K1 Grey cast iron / Grauguß	-	< 280	120	150	180
K2 Ductile cast iron / Sphäroguß	-	< 320	90	110	130
N1 Non-ferrous alloys / Nichteisenmetalle	< 250	< 110	-	-	-
N2 Aluminium alloys / Aluminiumlegierungen	< 530	< 130	-	-	-
S1 High temperature alloys Fe, Ni and Co based / Warmfeste Leg. Fe, Ni und Co	< 3300	< 350	40	50	60
S2 Titanium alloys; Alpha and Beta / Titan Legierungen Alpha und Beta	< 2100	< 400	60	70	80
H1 Hardened steel / Gehärtete Stähle	-	< 54 HRC	90	120	150
H2 Hardened steel / Gehärtete Stähle	-	52-60 HRC	70	100	130
H3 Hardened steel / Gehärtete Stähle	-	> 58 HRC	-	-	-
G1 Graphite / Graphit	-	-	-	-	-

Cutting conditions / Zerspanungswerte

Peripheral milling / Umfangfräsen



Dc	Ap [1xD]	Ae 1 [0.3xD]	Ae 2	fz 1 ▼▼	fz 2 ▼
3,0	3,0	0,9	-	0,015	0,025
3,5	3,5	1,1	-	0,015	0,025
4,0	4,0	1,2	-	0,020	0,030
4,5	4,5	1,4	-	0,020	0,035
5,0	5,0	1,5	-	0,025	0,035
6,0	6,0	1,8	-	0,030	0,045
8,0	8,0	2,4	-	0,040	0,060
10,0	10,0	3,0	-	0,050	0,070
12,0	12,0	3,6	-	0,060	0,085
14,0	14,0	4,2	-	0,070	0,100
16,0	16,0	4,8	-	0,080	0,115
18,0	18,0	5,4	-	0,090	0,130
20,0	20,0	6,0	-	0,100	0,140

Slot milling / Vollnutfräsen



Dc	Ap [0.75xD]	Ae [1xD]	fz
3,0	2,3	3,0	0,020
3,5	2,6	3,5	0,025
4,0	3,0	4,0	0,025
4,5	3,4	4,5	0,030
5,0	3,8	5,0	0,030
6,0	4,5	6,0	0,035
8,0	6,0	8,0	0,050
10,0	7,5	10,0	0,060
12,0	9,0	12,0	0,070
14,0	10,5	14,0	0,085
16,0	12,0	16,0	0,095
18,0	13,5	18,0	0,105
20,0	15,0	20,0	0,120

4 flute end mill; 35°-38° helix; DIN6527S; short length; AlCrN coated
 Schaftfräser 4 Schneiden; 35°-38° Drallwinkel; DIN6527K; kurze Ausführung; AlCrN beschichtet

Specifications / Spezifikationen

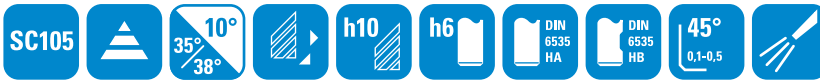

DIN 6535 HA	DIN 6535 HB	Dc	Ds	Lc	Ln	Dn	Lt	r	z
BLC4S03038VN	BLW4S03038VN	3,0	6	5	9	2,8	50	-	4
BLC4S03538VN	BLW4S03538VN	3,5	6	6	10	3,3	50	-	4
BLC4S04038VN	BLW4S04038VN	4,0	6	8	13	3,8	54	-	4
BLC4S04538VN	BLW4S04538VN	4,5	6	8	15	4,3	54	-	4
BLC4S05038VN	BLW4S05038VN	5,0	6	9	16	4,8	54	-	4
BLC4S06038VN	BLW4S06038VN	6,0	6	10	17	5,7	54	-	4
BLC4S08038VN	BLW4S08038VN	8,0	8	12	22	7,6	58	-	4
BLC4S10038VN	BLW4S10038VN	10,0	10	14	26	9,5	66	-	4
BLC4S12038VN	BLW4S12038VN	12,0	12	16	28	11,5	73	-	4
BLC4S14038VN	BLW4S14038VN	14,0	14	18	30	13,5	73	-	4
BLC4S16038VN	BLW4S16038VN	16,0	16	22	34	15,5	82	-	4
BLC4S18038VN	BLW4S18038VN	18,0	18	24	36	17,5	84	-	4
BLC4S20038VN	BLW4S20038VN	20,0	20	26	42	19,5	92	-	4



4 flute end mill; 35°-38° helix; DIN6527L; long length; AlCrN coated

Schaftfräser 4 Schneiden; 35°-38° Drallwinkel; DIN6527L; lange Ausführung; AlCrN beschichtet

Workpiece material groups and cutting speed / Werkstoffgruppen und Schnittgeschwindigkeiten

Material Material	Tensile strength Zugfestigkeit Rm [N/mm ²]	Hardness Härte [HB/HRC]	Cutting speed Vc [m/min] Schnittgeschwindigkeiten		
			min	opt	max
P1 Plain carbon steel / Unlegierter Stahl	< 600	< 230	180	210	240
P2 Alloy Steel / Legierter Stahl	< 1200	< 350	150	175	200
P3 High alloy steel and tool steel / Hochlegierter Stahl und Werkzeugstahl	< 1400	< 380	100	120	140
M1 Aust. and Ferr. Stainless steel / Aust. und Ferr. rostfreie Stähle	< 680	< 220	80	110	140
M2 Mart. Stainless steel / Mart. rostfreie Stähle	< 820	< 240	60	90	120
K1 Grey cast iron / Grauguß	-	< 280	120	150	180
K2 Ductile cast iron / Sphäroguß	-	< 320	90	110	130
N1 Non-ferrous alloys / Nichteisenmetalle	< 250	< 110	-	-	-
N2 Aluminium alloys / Aluminiumlegierungen	< 530	< 130	-	-	-
S1 High temperature alloys Fe, Ni and Co based / Warmfeste Leg. Fe, Ni und Co	< 3300	< 350	40	50	60
S2 Titanium alloys; Alpha and Beta / Titan Legierungen Alpha und Beta	< 2100	< 400	60	70	80
H1 Hardened steel / Gehärtete Stähle	-	< 54 HRC	90	120	150
H2 Hardened steel / Gehärtete Stähle	-	52-60 HRC	70	100	130
H3 Hardened steel / Gehärtete Stähle	-	> 58 HRC	-	-	-
G1 Graphite / Graphit	-	-	-	-	-

Cutting conditions / Zerspanungswerte

Peripheral milling / Umfangfräsen



Dc	Ap [1.5xD]	Ae 1 [0.3xD]	Ae 2	fz 1 ▼▼	fz 2 ▼
3,0	4,5	0,9	-	0,015	0,025
3,5	5,3	1,1	-	0,015	0,025
4,0	6,0	1,2	-	0,020	0,030
4,5	6,8	1,4	-	0,020	0,035
5,0	7,5	1,5	-	0,025	0,035
6,0	9,0	1,8	-	0,030	0,045
8,0	12,0	2,4	-	0,040	0,060
10,0	15,0	3,0	-	0,050	0,070
12,0	18,0	3,6	-	0,060	0,085
14,0	21,0	4,2	-	0,070	0,100
16,0	24,0	4,8	-	0,080	0,115
18,0	27,0	5,4	-	0,090	0,130
20,0	30,0	6,0	-	0,100	0,140

Slot milling / Vollnutfräsen



Dc	Ap [1xD]	Ae [1xD]	fz
3,0	3,0	3,0	0,020
3,5	3,5	3,5	0,025
4,0	4,0	4,0	0,025
4,5	4,5	4,5	0,030
5,0	5,0	5,0	0,030
6,0	6,0	6,0	0,035
8,0	8,0	8,0	0,050
10,0	10,0	10,0	0,060
12,0	12,0	12,0	0,070
14,0	14,0	14,0	0,085
16,0	16,0	16,0	0,095
18,0	18,0	18,0	0,105
20,0	20,0	20,0	0,120

4 flute end mill; 35°-38° helix; DIN6527L; long length; AlCrN coated
 Schaftfräser 4 Schneiden; 35°-38° Drallwinkel; DIN6527L; lange Ausführung; AlCrN beschichtet

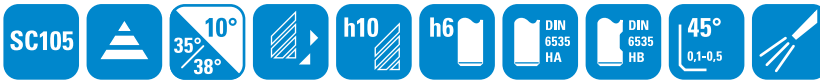
Specifications / Spezifikationen

DIN 6535 HA	DIN 6535 HB	Dc	Ds	Lc	Ln	Dn	Lt	r	z
BLC4L03038VN	BLW4L03038VN	3,0	6	8	14	2,8	57	-	4
BLC4L03538VN	BLW4L03538VN	3,5	6	10	16	3,3	57	-	4
BLC4L04038VN	BLW4L04038VN	4,0	6	11	16	3,8	57	-	4
BLC4L04538VN	BLW4L04538VN	4,5	6	11	18	4,3	57	-	4
BLC4L05038VN	BLW4L05038VN	5,0	6	13	18	4,8	57	-	4
BLC4L06038VN	BLW4L06038VN	6,0	6	13	19	5,7	57	-	4
BLC4L08038VN	BLW4L08038VN	8,0	8	19	25	7,6	63	-	4
BLC4L10038VN	BLW4L10038VN	10,0	10	22	30	9,5	72	-	4
BLC4L12038VN	BLW4L12038VN	12,0	12	26	36	11,5	83	-	4
BLC4L14038VN	BLW4L14038VN	14,0	14	26	36	13,5	83	-	4
BLC4L16038VN	BLW4L16038VN	16,0	16	32	42	15,5	92	-	4
BLC4L18038VN	BLW4L18038VN	18,0	18	32	42	17,5	92	-	4
BLC4L20038VN	BLW4L20038VN	20,0	20	38	52	19,5	104	-	4



4 flute torical end mill; 35°-38° helix; DIN6527L; long length; AlCrN coated

Torusfräser 4 Schneiden; 35°-38° Drallwinkel; DIN6527L; lange Ausführung; AlCrN beschichtet

Workpiece material groups and cutting speed / Werkstoffgruppen und Schnittgeschwindigkeiten

Material Material	Tensile strength Zugfestigkeit Rm [N/mm ²]	Hardness Härte [HB/HRC]	Cutting speed Vc [m/min] Schnittgeschwindigkeiten		
			min	opt	max
P1 Plain carbon steel / Unlegierter Stahl	< 600	< 230	180	210	240
P2 Alloy Steel / Legierter Stahl	< 1200	< 350	150	175	200
P3 High alloy steel and tool steel / Hochlegierter Stahl und Werkzeugstahl	< 1400	< 380	100	120	140
M1 Aust. and Ferr. Stainless steel / Aust. und Ferr. rostfreie Stähle	< 680	< 220	80	110	140
M2 Mart. Stainless steel / Mart. rostfreie Stähle	< 820	< 240	60	90	120
K1 Grey cast iron / Grauguß	-	< 280	120	150	180
K2 Ductile cast iron / Sphäroguß	-	< 320	90	110	130
N1 Non-ferrous alloys / Nichteisenmetalle	< 250	< 110	-	-	-
N2 Aluminium alloys / Aluminiumlegierungen	< 530	< 130	-	-	-
S1 High temperature alloys Fe, Ni and Co based / Warmfeste Leg. Fe, Ni und Co	< 3300	< 350	40	50	60
S2 Titanium alloys; Alpha and Beta / Titan Legierungen Alpha und Beta	< 2100	< 400	60	70	80
H1 Hardened steel / Gehärtete Stähle	-	< 54 HRC	90	120	150
H2 Hardened steel / Gehärtete Stähle	-	52-60 HRC	70	100	130
H3 Hardened steel / Gehärtete Stähle	-	> 58 HRC	-	-	-
G1 Graphite / Graphit	-	-	-	-	-

Cutting conditions / Zerspanungswerte

Peripheral milling / Umfangfräsen



Dc	Ap [1.5xD]	Ae 1 [0.3xD]	Ae 2	fz 1 ▼▼	fz 2 ▼
6,0	9,0	1,8	-	0,015	0,025
8,0	12,0	2,4	-	0,015	0,025
10,0	15,0	3,0	-	0,020	0,030
12,0	18,0	3,6	-	0,020	0,035
16,0	24,0	4,8	-	0,025	0,035

Slot milling / Vollnutfräsen



Dc	Ap [1xD]	Ae [1xD]	fz
6,0	6,0	6,0	0,020
8,0	8,0	8,0	0,025
10,0	10,0	10,0	0,025
12,0	12,0	12,0	0,030
16,0	16,0	16,0	0,030

4 flute torical end mill; 35°-38° helix; DIN6527L; long length; AlCrN coated
 Torusfräser 4 Schneiden; 35°-38° Drallwinkel; DIN6527L; lange Ausführung; AlCrN beschichtet

Specifications / Spezifikationen

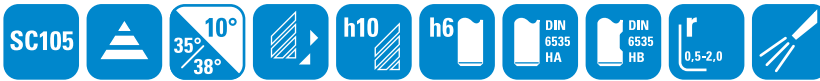

DIN 6535 HA	DIN 6535 HB	Dc	Ds	Lc	Ln	Dn	Lt	r	z
BLC4L06038VNT05	BLW4L06038VNT05	6,0	6	13	19	5,7	57	0,5	4
BLC4L06038VNT10	BLW4L06038VNT10	6,0	6	13	19	5,7	57	1,0	4
BLC4L08038VNT05	BLW4L08038VNT05	8,0	8	19	25	7,6	63	0,5	4
BLC4L08038VNT10	BLW4L08038VNT10	8,0	8	19	25	7,6	63	1,0	4
BLC4L10038VNT05	BLW4L10038VNT05	10,0	10	22	30	9,5	72	0,5	4
BLC4L10038VNT10	BLW4L10038VNT10	10,0	10	22	30	9,5	72	1,0	4
BLC4L10038VNT20	BLW4L10038VNT20	10,0	10	22	30	9,5	72	2,0	4
BLC4L12038VNT05	BLW4L12038VNT05	12,0	12	26	36	11,5	83	0,5	4
BLC4L12038VNT10	BLW4L12038VNT10	12,0	12	26	36	11,5	83	1,0	4
BLC4L12038VNT20	BLW4L12038VNT20	12,0	12	26	36	11,5	83	2,0	4
BLC4L16038VNT05	BLW4L16038VNT05	16,0	16	32	42	15,5	92	0,5	4
BLC4L16038VNT10	BLW4L16038VNT10	16,0	16	32	42	15,5	92	1,0	4
BLC4L16038VNT20	BLW4L16038VNT20	16,0	16	32	42	15,5	92	2,0	4



CAM-EXPERT

BASIC LINE+

- ▶ 4 flute end mill; 36°-38° helix; DIN6527L; long length; AlTiN coated
- ▶ Schafffräser 4 Schneiden; 36°-38° Drallwinkel; DIN6527L; lange Ausführung; AlTiN beschichtet

The SCT 4 flute "CAM-EXPERT" variable helix geometry and unique end face geometry allow CAD/CAM users to drill, slot, ramp down and perform peripheral milling with 1 single tool.

Der SCT "CAM-EXPERT" Schafffräser mit 4 Schneiden, variabler Schneidengeometrie und einzigartiger Stirngeometrie, ermöglicht CAD/CAM Anwendern das Bohren, Nuten-/Umfangfräsen und Schrägeintauchen mit nur einem Werkzeug.



PAGE
12-13

UK

1 HIGH QUALITY COATING

The AlTiN coating isolates the solid carbide from the generated heat and allows long tool life as well as high cutting conditions.

2 VARIABLE HELIX GEOMETRY

The 36°-38° helix angle provides excellent stability for chatter free machining and leaves outstanding surface finish for both slot and peripheral milling.

3 UNIQUE END FACE GEOMETRY

The SCT end face geometry makes the tool suitable for drilling applications up to 2xD and provides excellent conditions for ramping down to 45°.

D

1 HOCHWERTIGE QUALITÄTSBESCHICHTUNG

Die AlTiN Beschichtung isoliert den Vollhartmetall Schafffräser vor der erzeugten Wärme und ermöglicht lange Standzeiten sowie hohe Schnittbedingungen.

2 VARIABLE SCHNEIDENGEOMETRIE

Der ungleiche Spiralwinkel von 36°-38° gibt dem Fräser eine exzellente Stabilität zur vibrationsfreien Bearbeitung und überzeugt durch eine hervorragende Oberflächengüte, sowohl beim Nut- als auch beim Umfangfräsen.

3 EINZIGARTIGE STIRNGEOMETRIE

Die spezielle SCT Stirngeometrie des Werkzeugs ist zum Bohren für bis zu 2xD und zum Eintauchen im 45° Winkel exzellent geeignet.

Peripheral milling
Umfangfräsen



Slot milling
Vollnutfräsen



Ramp milling
Schräg eintauchen



Drilling
Bohren

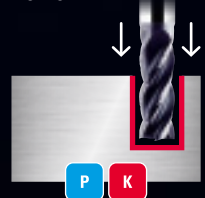

* Ramping MAX 5°-10° / * Schräg eintauchen MAX 5°-10°

4 flute end mill; 36°-38° helix; DIN6527L; long length; AlTiN coated

Schafffräser 4 Schneiden; 36°-38° Drallwinkel; DIN6527L; lange Ausführung; AlTiN beschichtet

Workpiece material groups and cutting speed / Werkstoffgruppen und Schnittgeschwindigkeiten

Material Material	Tensile strength Zugfestigkeit Rm [N/mm ²]	Hardness Härte [HB/HRC]	Cutting speed Vc [m/min] Schnittgeschwindigkeiten		
			min	opt	max
P1 Plain carbon steel / Unlegierter Stahl	< 600	< 230	180	210	240
P2 Alloy Steel / Legierter Stahl	< 1200	< 350	150	175	200
P3 High alloy steel and tool steel / Hochlegierter Stahl und Werkzeugstahl	< 1400	< 380	100	120	140
M1 Aust. and Ferr. Stainless steel* / Aust. und Ferr. rostfreie Stähle*	< 680	< 220	80	110	140
M2 Mart. Stainless steel* / Mart. rostfreie Stähle*	< 820	< 240	60	90	120
K1 Grey cast iron / Grauguß	-	< 280	120	150	180
K2 Ductile cast iron / Sphäroguß	-	< 320	90	110	130
N1 Non-ferrous alloys / Nichteisenmetalle	< 250	< 110	-	-	-
N2 Aluminium alloys / Aluminiumlegierungen	< 530	< 130	-	-	-
S1 High temperature alloys Fe, Ni and Co based* / Warmfeste Leg. Fe, Ni und Co*	< 3300	< 350	40	50	60
S2 Titanium alloys; Alpha and Beta* / Titan Legierungen Alpha und Beta*	< 2100	< 400	60	70	80
H1 Hardened steel / Gehärtete Stähle	-	< 54 HRC	-	-	-
H2 Hardened steel / Gehärtete Stähle	-	52-60 HRC	-	-	-
H3 Hardened steel / Gehärtete Stähle	-	> 58 HRC	-	-	-
G1 Graphite / Graphit	-	-	-	-	-

Cutting conditions / Zerspanungswerte

Peripheral milling / Umfangfräsen



	fz [beim Ae = 0,3xD / Ap = 1,5xD]					
	5,7-6	7,7-8	9,7-10	11,7-12	15,7-16	19,7-20
P1	0,045	0,060	0,070	0,085	0,115	0,140
P2	0,040	0,055	0,065	0,080	0,100	0,120
P3	0,035	0,050	0,060	0,075	0,085	0,100
M1	0,030	0,040	0,055	0,070	0,075	0,085
M2	0,030	0,040	0,050	0,055	0,070	0,080
K1	0,030	0,045	0,060	0,075	0,090	0,110
K2	0,030	0,045	0,060	0,075	0,090	0,110
S1	0,030	0,040	0,055	0,070	0,075	0,085
S2	0,030	0,040	0,050	0,055	0,070	0,080

Slot milling / Vollnutfräsen



	fz [beim Ae = 1xD / Ap = 1xD]					
	5,7-6	7,7-8	9,7-10	11,7-12	15,7-16	19,7-20
P1	0,035	0,050	0,060	0,070	0,095	0,120
P2	0,030	0,045	0,055	0,060	0,085	0,100
P3	0,025	0,040	0,050	0,050	0,075	0,090
M1	0,020	0,030	0,045	0,060	0,065	0,075
M2	0,020	0,030	0,040	0,045	0,060	0,070
K1	0,025	0,035	0,050	0,060	0,080	0,100
K2	0,025	0,035	0,050	0,060	0,080	0,100
S1	0,020	0,030	0,045	0,060	0,065	0,075
S2	0,020	0,030	0,040	0,045	0,060	0,070

Ramp milling / Schräg eintauchen



	fz [beim Ae = 1xD / Ap = 1xD]					
	5,7-6	7,7-8	9,7-10	11,7-12	15,7-16	19,7-20
P1	0,025	0,038	0,045	0,050	0,070	0,090
P2	0,025	0,035	0,040	0,045	0,065	0,075
P3	0,020	0,030	0,035	0,040	0,055	0,070
M1	0,015	0,023	0,034	0,045	0,050	0,055
M2	0,015	0,020	0,030	0,035	0,045	0,050
K1	0,018	0,025	0,038	0,045	0,060	0,075
K2	0,018	0,025	0,038	0,045	0,060	0,075
S1	0,015	0,020	0,035	0,045	0,050	0,055
S2	0,015	0,020	0,030	0,035	0,045	0,050

Drilling / Bohren

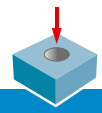

	fz					
	5,7-6	7,7-8	9,7-10	11,7-12	15,7-16	19,7-20
P1	0,018	0,025	0,030	0,035	0,048	0,060
P2	0,015	0,023	0,028	0,030	0,043	0,050
P3	0,013	0,020	0,025	0,025	0,038	0,045
M1	-	-	-	-	-	-
M2	-	-	-	-	-	-
K1	0,013	0,018	0,025	0,030	0,040	0,050
K2	0,013	0,018	0,025	0,030	0,040	0,050
S1	-	-	-	-	-	-
S2	-	-	-	-	-	-

*Drilling in material groups M1+M2 and S1+S2 is not recommended / *Das Bohren in den Werkstoffgruppen M1+M2 und S1+S2 wird nicht empfohlen

4 flute end mill; 36°-38° helix; DIN6527L; long length; AlTiN coated
 Schafffräser 4 Schneiden; 36°-38° Drallwinkel; DIN6527L; lange Ausführung; AlTiN beschichtet

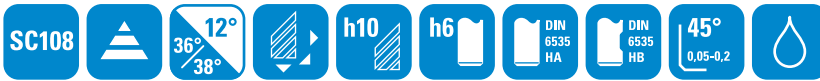
Specifications / Spezifikationen

DIN 6535 HA	DIN 6535 HB	Dc	Ds	Lc	Ln	Dn	Lt	r	z
BLC4L05738VND	BLW4L05738VND	5,7	6	13	19	5,4	57	-	4
BLC4L06038VND	BLW4L06038VND	6,0	6	13	19	5,7	57	-	4
BLC4L07738VND	BLW4L07738VND	7,7	8	19	25	7,3	63	-	4
BLC4L08038VND	BLW4L08038VND	8,0	8	19	25	7,6	63	-	4
BLC4L09738VND	BLW4L09738VND	9,7	10	22	30	9,2	72	-	4
BLC4L10038VND	BLW4L10038VND	10,0	10	22	30	9,5	72	-	4
BLC4L11738VND	BLW4L11738VND	11,7	12	26	36	11,2	83	-	4
BLC4L12038VND	BLW4L12038VND	12,0	12	26	36	11,5	83	-	4
BLC4L13738VND	BLW4L13738VND	13,7	14	26	36	13,2	83	-	4
BLC4L14038VND	BLW4L14038VND	14,0	14	26	36	13,5	83	-	4
BLC4L15638VND	BLW4L15638VND	15,6	16	32	42	15,1	92	-	4
BLC4L16038VND	BLW4L16038VND	16,0	16	32	42	15,5	92	-	4
BLC4L19538VND	BLW4L19538VND	19,5	20	38	52	19,0	104	-	4
BLC4L20038VND	BLW4L20038VND	20,0	20	38	52	19,5	104	-	4



TROCHOIDAL

BASIC LINE+

- ▶ 5-flute end mill; 37°-38° helix; SCT norm; XL length; AlCrN coated
- ▶ Schafffräser 5 Schneiden; 37°-38° Drallwinkel; SCT Norm; XL Ausführung; AlCrN beschichtet

The SCT 5 flute Trochoidal end mills combine a few unique characteristics to make them ideally suited for machining different types of steel (37°-38° helix) or stainless steel/heat resistant alloys (41°-42° helix) with the trochoidal milling techniques.

Der 5-schneidige Trochoidal Fräser von SCT kombiniert mehrere einzigartige Eigenschaften zur optimalen Bearbeitung von verschiedenen Stählen (37°-38° Drallwinkel) sowie rostfreie Stähle/hitzebeständigen Legierungen (41°-42° Drallwinkel) mit der neuen, trochoidalen Frästechnik.

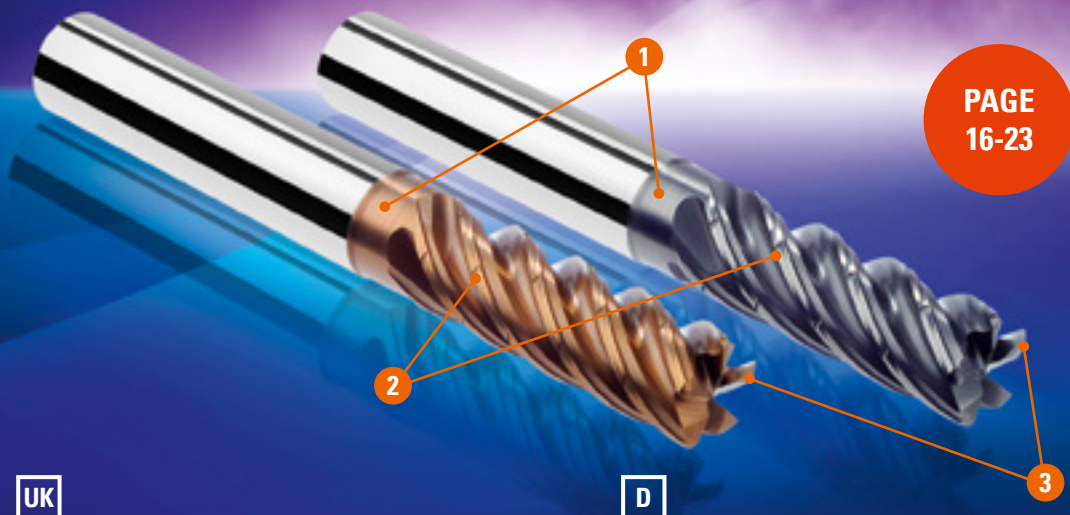

PAGE
16-23

UK

1 EXTRA LONG CUTTING LENGTH

3xD Cutting length in a variable 37°-38° helix geometry for machining steel and a variable 41°-42° helix geometry for stainless steel and other heat resistant alloys.

2 CHIP BREAKER

The chip breaker creates short chips and smooth chip evacuation to serve high cutting speeds when using the entire flute length.

3 CORNER RADIUS AND CHAMFER

The 5 flute trochoidal tools are available with various corner radius and chamfer sizes.

D

1 XL-SCHNEIDLÄNGE

3xD Schneidlänge mit variablem 37°-38°-Drallwinkel für Automatenstahl sowie variablem 41°-42°-Drallwinkel für rostfreie Stähle und hitzebeständige Legierungen.

2 SPEZIELLE SPANBRECHER-GEOMETRIE

Unsere spezielle Geometrie erzeugt kurze Späne und eine erleichterte Spanabfuhr, welche hohe Schnittgeschwindigkeiten beim Einsatz über die gesamte Nutlänge ermöglichen.

3 ECKENRADIUS UND ECKFASE

Die 5-schneidigen Trochoidal Fräser sind sowohl mit Eckenradius als auch mit Eckfase erhältlich.

Trochoidal milling / Trochoidal Fräsen

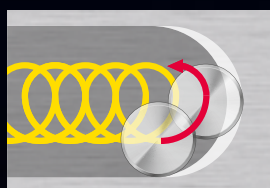

Static
statisch

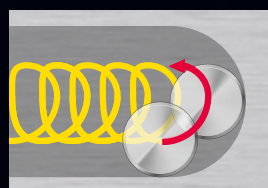

Dynamic
dynamisch



5 flute end mill; 37°-38° helix; SCT norm; XL length; AlCrN coated

Schaftfräser 5 Schneiden; 37°-38° Drallwinkel; SCT Norm; XL Ausführung; AlCrN beschichtet

Workpiece material groups and cutting speed / Werkstoffgruppen und Schnittgeschwindigkeiten

Material Material	Tensile strength Zugfestigkeit Rm [N/mm ²]	Hardness Härte [HB/HRC]	Cutting speed Vc [m/min] Schnittgeschwindigkeiten		
			min	opt	max
P1 Plain carbon steel / Unlegierter Stahl	< 600	< 230	220	300	380
P2 Alloy Steel / Legierter Stahl	< 1200	< 350	200	250	300
P3 High alloy steel and tool steel / Hochlegierter Stahl und Werkzeugstahl	< 1400	< 380	180	210	250
M1 Aust. and Ferr. Stainless steel / Aust. und Ferr. rostfreie Stähle	< 680	< 220	-	-	-
M2 Mart. Stainless steel / Mart. rostfreie Stähle	< 820	< 240	-	-	-
K1 Grey cast iron / Grauguß	-	< 280	-	-	-
K2 Ductile cast iron / Sphäroguß	-	< 320	-	-	-
N1 Non-ferrous alloys / Nichteisenmetalle	< 250	< 110	-	-	-
N2 Aluminium alloys / Aluminiumlegierungen	< 530	< 130	-	-	-
S1 High temperature alloys Fe, Ni and Co based / Warmfeste Leg. Fe, Ni und Co	< 3300	< 350	-	-	-
S2 Titanium alloys; Alpha and Beta / Titan Legierungen Alpha und Beta	< 2100	< 400	-	-	-
H1 Hardened steel / Gehärtete Stähle	-	< 54 HRC	70	100	130
H2 Hardened steel / Gehärtete Stähle	-	52-60 HRC	50	90	120
H3 Hardened steel / Gehärtete Stähle	-	> 58 HRC	-	-	-
G1 Graphite / Graphit	-	-	-	-	-

Cutting conditions / Zerspanungswerte

Trochoidal milling / Trochoidal Fräsen

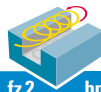

Dc	Ap [3xD]	Ae 1 [0.1xD]	Ae 2 [0.2xD]	fz 1 ▼▼	fz 2 ▼▼	hm
6	18	0,6	1,2	0,087	0,062	0,028
8	24	0,8	1,6	0,117	0,083	0,037
10	30	1,0	2,0	0,146	0,104	0,046
12	36	1,2	2,4	0,175	0,125	0,055
14	42	1,4	2,8	0,204	0,146	0,065
16	48	1,6	3,2	0,233	0,166	0,074
18	54	1,8	3,6	0,262	0,187	0,083
20	60	2,0	4,0	0,292	0,208	0,092
25	75	2,5	5,0	0,365	0,260	0,115

5 flute end mill; 37°-38° helix; SCT norm; XL length; AlCrN coated
 Schafffräser 5 Schneiden; 37°-38° Drallwinkel; SCT Norm; XL Ausführung; AlCrN beschichtet

Specifications / Spezifikationen

DIN 6535 HA	DIN 6535 HB	Dc	Ds	Lc	Ln	Dn	Lt	c [45°]	z
BLC5L06038VN	BLW5L06038VN	6	6	18	24	5,7	62	0,12	5
BLC5L08038VN	BLW5L08038VN	8	8	24	30	7,6	68	0,16	5
BLC5L10038VN	BLW5L10038VN	10	10	30	38	9,5	80	0,20	5
BLC5L12038VN	BLW5L12038VN	12	12	36	46	11,5	93	0,24	5
BLC5L14038VN	BLW5L14038VN	14	14	42	50	13,5	100	0,28	5
BLC5L16038VN	BLW5L16038VN	16	16	48	58	15,5	108	0,32	5
BLC5L18038VN	BLW5L18038VN	18	18	54	67	17,5	115	0,36	5
BLC5L20038VN	BLW5L20038VN	20	20	60	74	19,5	126	0,40	5
BLC5L25038VN	BLW5L25038VN	25	25	75	92	24,0	150	0,50	5



5 flute torical end mill; 37°-38° helix; SCT norm; XL length; AlCrN coated

Torusfräser 5 Schneiden; 37°-38° Drallwinkel; SCT Norm; XL Ausführung; AlCrN beschichtet

Workpiece material groups and cutting speed / Werkstoffgruppen und Schnittgeschwindigkeiten

Material Material	Tensile strength Zugfestigkeit Rm [N/mm ²]	Hardness Härte [HB/HRC]	Cutting speed Vc [m/min] Schnittgeschwindigkeiten		
			min	opt	max
P1 Plain carbon steel / Unlegierter Stahl	< 600	< 230	220	300	380
P2 Alloy Steel / Legierter Stahl	< 1200	< 350	200	250	300
P3 High alloy steel and tool steel / Hochlegierter Stahl und Werkzeugstahl	< 1400	< 380	180	210	250
M1 Aust. and Ferr. Stainless steel / Aust. und Ferr. rostfreie Stähle	< 680	< 220	-	-	-
M2 Mart. Stainless steel / Mart. rostfreie Stähle	< 820	< 240	-	-	-
K1 Grey cast iron / Grauguß	-	< 280	-	-	-
K2 Ductile cast iron / Sphäroguß	-	< 320	-	-	-
N1 Non-ferrous alloys / Nichteisenmetalle	< 250	< 110	-	-	-
N2 Aluminium alloys / Aluminiumlegierungen	< 530	< 130	-	-	-
S1 High temperature alloys Fe, Ni and Co based / Warmfeste Leg. Fe, Ni und Co	< 3300	< 350	-	-	-
S2 Titanium alloys; Alpha and Beta / Titan Legierungen Alpha und Beta	< 2100	< 400	-	-	-
H1 Hardened steel / Gehärtete Stähle	-	< 54 HRC	70	100	130
H2 Hardened steel / Gehärtete Stähle	-	52-60 HRC	50	90	120
H3 Hardened steel / Gehärtete Stähle	-	> 58 HRC	-	-	-
G1 Graphite / Graphit	-	-	-	-	-

Cutting conditions / Zerspanungswerte

Trochoidal milling / Trochoidal Fräsen



Dc	Ap [3xD]	Ae 1 [0.1xD]	Ae 2 [0.2xD]	fz 1 ▼▼	fz 2 ▼▼	hm
6	18	0,6	1,2	0,087	0,062	0,028
8	24	0,8	1,6	0,117	0,083	0,037
10	30	1,0	2,0	0,146	0,104	0,046
12	36	1,2	2,4	0,175	0,125	0,055
14	42	1,4	2,8	0,204	0,146	0,065
16	48	1,6	3,2	0,233	0,166	0,074
18	54	1,8	3,6	0,262	0,187	0,083
20	60	2,0	4,0	0,292	0,208	0,092
25	75	2,5	5,0	0,365	0,260	0,115

5 flute torical end mill; 37°-38° helix; SCT norm; XL length; AlCrN coated
 Torusfräser 5 Schneiden; 37°-38° Drallwinkel; SCT Norm; XL Ausführung; AlCrN beschichtet

Specifications / Spezifikationen

DIN 6535 HA	DIN 6535 HB	Dc	Ds	Lc	Ln	Dn	Lt	r	z
BLC5L06038VNT05	BLW5L06038VNT05	6	6	18	24	5,7	62	0,5	5
BLC5L06038VNT10	BLW5L06038VNT10	6	6	18	24	5,7	62	1,0	5
BLC5L08038VNT05	BLW5L08038VNT05	8	8	24	30	7,6	68	0,5	5
BLC5L08038VNT10	BLW5L08038VNT10	8	8	24	30	7,6	68	1,0	5
BLC5L10038VNT05	BLW5L10038VNT05	10	10	30	38	9,5	80	0,5	5
BLC5L10038VNT10	BLW5L10038VNT10	10	10	30	38	9,5	80	1,0	5
BLC5L10038VNT20	BLW5L10038VNT20	10	10	30	38	9,5	80	2,0	5
BLC5L12038VNT05	BLW5L12038VNT05	12	12	36	46	11,5	93	0,5	5
BLC5L12038VNT10	BLW5L12038VNT10	12	12	36	46	11,5	93	1,0	5
BLC5L12038VNT20	BLW5L12038VNT20	12	12	36	46	11,5	93	2,0	5
BLC5L16038VNT05	BLW5L16038VNT05	16	16	48	58	15,5	108	0,5	5
BLC5L16038VNT10	BLW5L16038VNT10	16	16	48	58	15,5	108	1,0	5
BLC5L16038VNT20	BLW5L16038VNT20	16	16	48	58	15,5	108	2,0	5
BLC5L20038VNT10	BLW5L20038VNT10	20	20	60	74	19,5	126	1,0	5
BLC5L20038VNT20	BLW5L20038VNT20	20	20	60	74	19,5	126	2,0	5
BLC5L20038VNT30	BLW5L20038VNT30	20	20	60	74	19,5	126	3,0	5



5 flute end mill; 41°-42° helix; SCT norm; XL length; AlCr-based coated

Schaftfräser 5 Schneiden; 41°-42° Drallwinkel; SCT Norm; XL Ausführung; AlCr-basierte Schicht

Workpiece material groups and cutting speed / Werkstoffgruppen und Schnittgeschwindigkeiten

Material Material	Tensile strength Zugfestigkeit Rm [N/mm ²]	Hardness Härte [HB/HRC]	Cutting speed Vc [m/min] Schnittgeschwindigkeiten		
			min	opt	max
P1 Plain carbon steel / Unlegierter Stahl	< 600	< 230	-	-	-
P2 Alloy Steel / Legierter Stahl	< 1200	< 350	-	-	-
P3 High alloy steel and tool steel / Hochlegierter Stahl und Werkzeugstahl	< 1400	< 380	-	-	-
M1 Aust. and Ferr. Stainless steel / Aust. und Ferr. rostfreie Stähle	< 680	< 220	150	190	230
M2 Mart. Stainless steel / Mart. rostfreie Stähle	< 820	< 240	130	170	200
K1 Grey cast iron / Grauguß	-	< 280	-	-	-
K2 Ductile cast iron / Sphäroguß	-	< 320	-	-	-
N1 Non-ferrous alloys / Nichteisenmetalle	< 250	< 110	-	-	-
N2 Aluminium alloys / Aluminiumlegierungen	< 530	< 130	-	-	-
S1 High temperature alloys Fe, Ni and Co based / Warmfeste Leg. Fe, Ni und Co	< 3300	< 350	50	80	100
S2 Titanium alloys; Alpha and Beta / Titan Legierungen Alpha und Beta	< 2100	< 400	80	130	170
H1 Hardened steel / Gehärtete Stähle	-	< 54 HRC	-	-	-
H2 Hardened steel / Gehärtete Stähle	-	52-60 HRC	-	-	-
H3 Hardened steel / Gehärtete Stähle	-	> 58 HRC	-	-	-
G1 Graphite / Graphit	-	-	-	-	-

Cutting conditions / Zerspanungswerte

Trochoidal milling / Trochoidal Fräsen

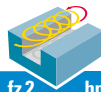

Dc	Ap [3xD]	Ae 1 [0.06xD]	Ae 2 [0.12xD]	fz 1 ▼▼	fz 2 ▼▼	hm
6	18	0,36	0,72	0,072	0,030	0,018
8	24	0,48	0,96	0,096	0,040	0,024
10	30	0,60	1,20	0,120	0,050	0,029
12	36	0,72	1,44	0,144	0,060	0,035
14	42	0,84	1,68	0,168	0,070	0,041
16	48	0,96	1,92	0,192	0,080	0,047
18	54	1,08	2,16	0,216	0,090	0,053
20	60	1,20	2,40	0,240	0,100	0,059
25	75	1,50	3,00	0,300	0,125	0,073

5 flute end mill; 41°-42° helix; SCT norm; XL length; AlCr-based coated
 Schafffräser 5 Schneiden; 41°-42° Drallwinkel; SCT Norm; XL Ausführung; AlCr-basierte Schicht

Specifications / Spezifikationen

DIN 6535 HA	DIN 6535 HB	Dc	Ds	Lc	Ln	Dn	Lt	c [45°]	z
BLC5L06042VN	BLW5L06042VN	6	6	18	24	5,7	62	0,12	5
BLC5L08042VN	BLW5L08042VN	8	8	24	30	7,6	68	0,16	5
BLC5L10042VN	BLW5L10042VN	10	10	30	38	9,5	80	0,20	5
BLC5L12042VN	BLW5L12042VN	12	12	36	46	11,5	93	0,24	5
BLC5L14042VN	BLW5L14042VN	14	14	42	50	13,5	100	0,28	5
BLC5L16042VN	BLW5L16042VN	16	16	48	58	15,5	108	0,32	5
BLC5L18042VN	BLW5L18042VN	18	18	54	67	17,5	115	0,36	5
BLC5L20042VN	BLW5L20042VN	20	20	60	74	19,5	126	0,40	5
BLC5L25042VN	BLW5L25042VN	25	25	75	92	24,0	150	0,50	5



5 flute torical end mill; 41°-42° helix; SCT norm; XL length; AlCr-based coated
Torusfräser 5 Schneiden; 41°-42° Drallwinkel; SCT Norm; XL Ausführung; AlCr-basierte Schicht
Specifications / Spezifikationen

DIN 6535 HA	DIN 6535 HB	Dc	Ds	Lc	Ln	Dn	Lt	r	z
BLC5L06042VNT01	BLW5L06042VNT01	6	6	18	24	5,7	62	0,1	5
BLC5L06042VNT05	BLW5L06042VNT05	6	6	18	24	5,7	62	0,5	5
BLC5L06042VNT10	BLW5L06042VNT10	6	6	18	24	5,7	62	1,0	5
BLC5L08042VNT02	BLW5L08042VNT02	8	8	24	30	7,6	68	0,2	5
BLC5L08042VNT05	BLW5L08042VNT05	8	8	24	30	7,6	68	0,5	5
BLC5L08042VNT10	BLW5L08042VNT10	8	8	24	30	7,6	68	1,0	5
BLC5L10042VNT02	BLW5L10042VNT02	10	10	30	38	9,5	80	0,2	5
BLC5L10042VNT05	BLW5L10042VNT05	10	10	30	38	9,5	80	0,5	5
BLC5L10042VNT10	BLW5L10042VNT10	10	10	30	38	9,5	80	1,0	5
BLC5L10042VNT20	BLW5L10042VNT20	10	10	30	38	9,5	80	2,0	5
BLC5L12042VNT03	BLW5L12042VNT03	12	12	36	46	11,5	93	0,3	5
BLC5L12042VNT05	BLW5L12042VNT05	12	12	36	46	11,5	93	0,5	5
BLC5L12042VNT10	BLW5L12042VNT10	12	12	36	46	11,5	93	1,0	5
BLC5L12042VNT20	BLW5L12042VNT20	12	12	36	46	11,5	93	2,0	5
BLC5L16042VNT03	BLW5L16042VNT03	16	16	48	58	15,5	108	0,3	5
BLC5L16042VNT05	BLW5L16042VNT05	16	16	48	58	15,5	108	0,5	5
BLC5L16042VNT10	BLW5L16042VNT10	16	16	48	58	15,5	108	1,0	5
BLC5L16042VNT20	BLW5L16042VNT20	16	16	48	58	15,5	108	2,0	5
BLC5L20042VNT03	BLW5L20042VNT03	20	20	60	74	19,5	126	0,3	5
BLC5L20042VNT10	BLW5L20042VNT10	20	20	60	74	19,5	126	1,0	5
BLC5L20042VNT20	BLW5L20042VNT20	20	20	60	74	19,5	126	2,0	5
BLC5L20042VNT30	BLW5L20042VNT30	20	20	60	74	19,5	126	3,0	5



Multi flute rougher; 45° helix; DIN6527S; short length; AlCrN coated

Schruppfräser multi Schneiden; 45° Drallwinkel; DIN6527K; kurze Ausführung; AlCrN beschichtet

Workpiece material groups and cutting speed / Werkstoffgruppen und Schnittgeschwindigkeiten

Material Material	Tensile strength Zugfestigkeit Rm [N/mm ²]	Hardness Härte [HB/HRC]	Cutting speed Vc [m/min] Schnittgeschwindigkeiten		
			min	opt	max
P1 Plain carbon steel / Unlegierter Stahl	< 600	< 230	180	210	240
P2 Alloy Steel / Legierter Stahl	< 1200	< 350	150	175	200
P3 High alloy steel and tool steel / Hochlegierter Stahl und Werkzeugstahl	< 1400	< 380	100	120	140
M1 Aust. and Ferr. Stainless steel / Aust. und Ferr. rostfreie Stähle	< 680	< 220	80	110	140
M2 Mart. Stainless steel / Mart. rostfreie Stähle	< 820	< 240	60	90	120
K1 Grey cast iron / Grauguß	-	< 280	120	150	180
K2 Ductile cast iron / Sphäroguß	-	< 320	90	110	130
N1 Non-ferrous alloys / Nichteisenmetalle	< 250	< 110	-	-	-
N2 Aluminium alloys / Aluminiumlegierungen	< 530	< 130	-	-	-
S1 High temperature alloys Fe, Ni and Co based / Warmfeste Leg. Fe, Ni und Co	< 3300	< 350	40	50	60
S2 Titanium alloys; Alpha and Beta / Titan Legierungen Alpha und Beta	< 2100	< 400	60	70	80
H1 Hardened steel / Gehärtete Stähle	-	< 54 HRC	90	120	150
H2 Hardened steel / Gehärtete Stähle	-	52-60 HRC	70	100	130
H3 Hardened steel / Gehärtete Stähle	-	> 58 HRC	-	-	-
G1 Graphite / Graphit	-	-	-	-	-

Cutting conditions / Zerspanungswerte

Peripheral milling / Umfangfräsen



Dc	Ap [1xD]	Ae 1 [0.4xD]	Ae 2	fz 1 ▼▼	fz 2 ▼
4,0	4,0	1,6	-	0,020	0,035
5,0	5,0	2,0	-	0,025	0,040
6,0	6,0	2,4	-	0,030	0,050
8,0	8,0	3,2	-	0,040	0,065
10,0	10,0	4,0	-	0,055	0,080
12,0	12,0	4,8	-	0,065	0,100
14,0	14,0	5,6	-	0,075	0,115
16,0	16,0	6,4	-	0,085	0,130
18,0	18,0	7,2	-	0,100	0,145
20,0	20,0	8,0	-	0,110	0,160

Slot milling / Vollnutfräsen



Dc	Ap [0.75xD]	Ae [1xD]	fz
4,0	3,0	4,0	0,030
5,0	3,8	5,0	0,035
6,0	4,5	6,0	0,045
8,0	6,0	8,0	0,060
10,0	7,5	10,0	0,070
12,0	9,0	12,0	0,085
14,0	10,5	14,0	0,100
16,0	12,0	16,0	0,115
18,0	13,5	18,0	0,130
20,0	15,0	20,0	0,140

Multi flute rougher; 45° helix; DIN6527S; short length; AlCrN coated
 Schruppfräser multi Schneiden; 45° Drallwinkel; DIN6527K; kurze Ausführung; AlCrN beschichtet

Specifications / Spezifikationen

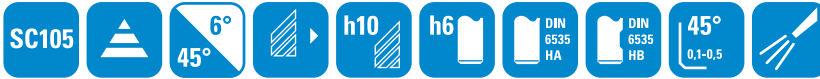

DIN 6535 HA	DIN 6535 HB	Dc	Ds	Lc	Ln	Dn	Lt	r	z
BLC3S04045RN	BLW3S04045RN	4,0	6	8	13	3,8	54	-	3
BLC4S05045RN	BLW4S05045RN	5,0	6	9	16	4,8	54	-	4
BLC4S06045RN	BLW4S06045RN	6,0	6	10	17	5,7	54	-	4
BLC4S08045RN	BLW4S08045RN	8,0	8	12	22	7,6	58	-	4
BLC4S10045RN	BLW4S10045RN	10,0	10	14	26	9,5	66	-	4
BLC4S12045RN	BLW4S12045RN	12,0	12	16	28	11,5	73	-	4
BLC4S14045RN	BLW4S14045RN	14,0	14	18	30	13,5	73	-	4
BLC4S16045RN	BLW4S16045RN	16,0	16	22	34	15,5	82	-	4
BLC5S16045RN	BLW5S16045RN	16,0	16	22	34	15,5	82	-	5
BLC5S18045RN	BLW5S18045RN	18,0	18	24	36	17,5	84	-	5
BLC5S20045RN	BLW5S20045RN	20,0	20	26	42	19,5	92	-	5
BLC6S20045RN	BLW6S20045RN	20,0	20	26	42	19,5	92	-	6



Multi flute rougher; 45° helix; DIN6527L; long length; AlCrN coated

Schruppfräser multi Schneiden; 45° Drallwinkel; DIN6527L; lange Ausführung; AlCrN beschichtet

Workpiece material groups and cutting speed / Werkstoffgruppen und Schnittgeschwindigkeiten

Material Material	Tensile strength Zugfestigkeit Rm [N/mm ²]	Hardness Härte [HB/HRC]	Cutting speed Vc [m/min] Schnittgeschwindigkeiten		
			min	opt	max
P1 Plain carbon steel / Unlegierter Stahl	< 600	< 230	180	210	240
P2 Alloy Steel / Legierter Stahl	< 1200	< 350	150	175	200
P3 High alloy steel and tool steel / Hochlegierter Stahl und Werkzeugstahl	< 1400	< 380	100	120	140
M1 Aust. and Ferr. Stainless steel / Aust. und Ferr. rostfreie Stähle	< 680	< 220	80	110	140
M2 Mart. Stainless steel / Mart. rostfreie Stähle	< 820	< 240	60	90	120
K1 Grey cast iron / Grauguß	-	< 280	120	150	180
K2 Ductile cast iron / Sphäroguß	-	< 320	90	110	130
N1 Non-ferrous alloys / Nichteisenmetalle	< 250	< 110	-	-	-
N2 Aluminium alloys / Aluminiumlegierungen	< 530	< 130	-	-	-
S1 High temperature alloys Fe, Ni and Co based / Warmfeste Leg. Fe, Ni und Co	< 3300	< 350	40	50	60
S2 Titanium alloys; Alpha and Beta / Titan Legierungen Alpha und Beta	< 2100	< 400	60	70	80
H1 Hardened steel / Gehärtete Stähle	-	< 54 HRC	90	120	150
H2 Hardened steel / Gehärtete Stähle	-	52-60 HRC	70	100	130
H3 Hardened steel / Gehärtete Stähle	-	> 58 HRC	-	-	-
G1 Graphite / Graphit	-	-	-	-	-

Cutting conditions / Zerspanungswerte

Peripheral milling / Umfangfräsen



Dc	Ap [1.5xD]	Ae 1 [0.4xD]	Ae 2	fz 1 ▼▼	fz 2 ▼
4,0	6,0	1,6	-	0,020	0,035
5,0	7,5	2,0	-	0,025	0,040
6,0	9,0	2,4	-	0,030	0,050
8,0	12,0	3,2	-	0,040	0,065
10,0	15,0	4,0	-	0,055	0,080
12,0	18,0	4,8	-	0,065	0,100
14,0	21,0	5,6	-	0,075	0,115
16,0	24,0	6,4	-	0,085	0,130
18,0	27,0	7,2	-	0,100	0,145
20,0	30,0	8,0	-	0,110	0,160

Slot milling / Vollnutfräsen



Dc	Ap [1xD]	Ae [1xD]	fz
4,0	4,0	4,0	0,030
5,0	5,0	5,0	0,035
6,0	6,0	6,0	0,045
8,0	8,0	8,0	0,060
10,0	10,0	10,0	0,070
12,0	12,0	12,0	0,085
14,0	14,0	14,0	0,100
16,0	16,0	16,0	0,115
18,0	18,0	18,0	0,130
20,0	20,0	20,0	0,140

Multi flute rougher; 45° helix; DIN6527L; long length; AlCrN coated
 Schruppfräser multi Schneiden; 45° Drallwinkel; DIN6527L; lange Ausführung; AlCrN beschichtet

Specifications / Spezifikationen

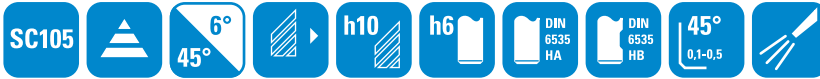

DIN 6535 HA	DIN 6535 HB	Dc	Ds	Lc	Ln	Dn	Lt	r	z
BLC3L04045RN	BLW3L04045RN	4,0	6	11	16	3,8	57	-	3
BLC4L05045RN	BLW4L05045RN	5,0	6	13	18	4,8	57	-	4
BLC4L06045RN	BLW4L06045RN	6,0	6	13	19	5,7	57	-	4
BLC4L08045RN	BLW4L08045RN	8,0	8	19	25	7,6	63	-	4
BLC4L10045RN	BLW4L10045RN	10,0	10	22	30	9,5	72	-	4
BLC4L12045RN	BLW4L12045RN	12,0	12	26	36	11,5	83	-	4
BLC4L14045RN	BLW4L14045RN	14,0	14	26	36	13,5	83	-	4
BLC4L16045RN	BLW4L16045RN	16,0	16	32	42	15,5	92	-	4
BLC5L16045RN	BLW5L16045RN	16,0	16	32	42	15,5	92	-	5
BLC5L18045RN	BLW5L18045RN	18,0	18	32	42	17,5	92	-	5
BLC5L20045RN	BLW5L20045RN	20,0	20	38	52	19,5	104	-	5
BLC6L20045RN	BLW6L20045RN	20,0	20	38	52	19,5	104	-	6



Multi flute end mill; 45° helix; DIN6527L; long length; AlCrN coated

Schaftfräser multi Schneiden; 45° Drallwinkel; DIN6527L; lange Ausführung; AlCrN beschichtet

Workpiece material groups and cutting speed / Werkstoffgruppen und Schnittgeschwindigkeiten

Material Material	Tensile strength Zugfestigkeit Rm [N/mm ²]	Hardness Härte [HB/HRC]	Cutting speed Vc [m/min] Schnittgeschwindigkeiten		
			min	opt	max
P1 Plain carbon steel / Unlegierter Stahl	< 600	< 230	-	-	-
P2 Alloy Steel / Legierter Stahl	< 1200	< 350	150	175	200
P3 High alloy steel and tool steel / Hochlegierter Stahl und Werkzeugstahl	< 1400	< 380	100	120	140
M1 Aust. and Ferr. Stainless steel / Aust. und Ferr. rostfreie Stähle	< 680	< 220	-	-	-
M2 Mart. Stainless steel / Mart. rostfreie Stähle	< 820	< 240	-	-	-
K1 Grey cast iron / Grauguß	-	< 280	120	150	180
K2 Ductile cast iron / Sphäroguß	-	< 320	90	110	130
N1 Non-ferrous alloys / Nichteisenmetalle	< 250	< 110	-	-	-
N2 Aluminium alloys / Aluminiumlegierungen	< 530	< 130	-	-	-
S1 High temperature alloys Fe, Ni and Co based / Warmfeste Leg. Fe, Ni und Co	< 3300	< 350	-	-	-
S2 Titanium alloys; Alpha and Beta / Titan Legierungen Alpha und Beta	< 2100	< 400	-	-	-
H1 Hardened steel / Gehärtete Stähle	-	< 54 HRC	150	180	210
H2 Hardened steel / Gehärtete Stähle	-	52-60 HRC	120	150	180
H3 Hardened steel / Gehärtete Stähle	-	> 58 HRC	90	120	150
G1 Graphite / Graphit	-	-	-	-	-

Cutting conditions / Zerspanungswerte

Peripheral milling / Umfangfräsen



Dc	Ap	Ae 1	Ae 2	fz 1	fz 2
	[1.5xD]	[0.015xD]	[0.03xD]	▼▼	▼
6,0	9,0	0,09	0,18	0,030	0,035
8,0	12,0	0,12	0,24	0,040	0,045
10,0	15,0	0,15	0,30	0,045	0,060
12,0	18,0	0,18	0,36	0,055	0,070
16,0	24,0	0,24	0,48	0,075	0,095
20,0	30,0	0,30	0,60	0,090	0,120

Multi flute end mill; 45° helix; DIN6527L; long length; AlCrN coated
 Schafffräser multi Schneiden; 45° Drallwinkel; DIN6527L; lange Ausführung; AlCrN beschichtet

Specifications / Spezifikationen



DIN 6535 HA	DIN 6535 HB	Dc	Ds	Lc	Ln	Dn	Lt	r	z
BLC6L06045SN	BLW6L06045SN	6,0	6	13	19	5,7	57	-	6
BLC6L08045SN	BLW6L08045SN	8,0	8	19	25	7,6	63	-	6
BLC6L10045SN	BLW6L10045SN	10,0	10	22	30	9,5	72	-	6
BLC6L12045SN	BLW6L12045SN	12,0	12	26	36	11,5	83	-	6
BLC6L16045SN	BLW6L16045SN	16,0	16	32	42	15,5	92	-	6
BLC8L20045SN	BLW8L20045SN	20,0	20	38	52	19,5	104	-	8



4 flute end mill; 40°-42° helix; DIN6527L; long length; AlCrN-based coated

Schafffräser 4 Schneiden; 40°-42° Drallwinkel; DIN6527L; lange Ausführung; AlCrN-basierte Schicht

Workpiece material groups and cutting speed / Werkstoffgruppen und Schnittgeschwindigkeiten

Material Material	Tensile strength Zugfestigkeit Rm [N/mm ²]	Hardness Härte [HB/HRC]	Cutting speed Vc [m/min] Schnittgeschwindigkeiten		
			min	opt	max
P1 Plain carbon steel / Unlegierter Stahl	< 600	< 230	-	-	-
P2 Alloy Steel / Legierter Stahl	< 1200	< 350	-	-	-
P3 High alloy steel and tool steel / Hochlegierter Stahl und Werkzeugstahl	< 1400	< 380	-	-	-
M1 Aust. and Ferr. Stainless steel / Aust. und Ferr. rostfreie Stähle	< 680	< 220	90	120	150
M2 Mart. Stainless steel / Mart. rostfreie Stähle	< 820	< 240	70	100	130
K1 Grey cast iron / Grauguß	-	< 280	-	-	-
K2 Ductile cast iron / Sphäroguß	-	< 320	-	-	-
N1 Non-ferrous alloys / Nichteisenmetalle	< 250	< 110	-	-	-
N2 Aluminium alloys / Aluminiumlegierungen	< 530	< 130	-	-	-
S1 High temperature alloys Fe, Ni and Co based / Warmfeste Leg. Fe, Ni und Co	< 3300	< 350	60	70	80
S2 Titanium alloys; Alpha and Beta / Titan Legierungen Alpha und Beta	< 2100	< 400	80	90	100
H1 Hardened steel / Gehärtete Stähle	-	< 54 HRC	-	-	-
H2 Hardened steel / Gehärtete Stähle	-	52-60 HRC	-	-	-
H3 Hardened steel / Gehärtete Stähle	-	> 58 HRC	-	-	-
G1 Graphite / Graphit	-	-	-	-	-

Cutting conditions / Zerspanungswerte

Peripheral milling / Umfangfräsen



Dc	Ap [1.5xD]	Ae 1 [0.3xD]	Ae 2	fz 1 ▼▼	fz 2 ▼
3,0	4,5	0,9	-	0,015	0,025
3,5	5,3	1,1	-	0,015	0,025
4,0	6,0	1,2	-	0,020	0,030
4,5	6,8	1,4	-	0,020	0,035
5,0	7,5	1,5	-	0,025	0,035
6,0	9,0	1,8	-	0,030	0,045
8,0	12,0	2,4	-	0,040	0,060
10,0	15,0	3,0	-	0,050	0,070
12,0	18,0	3,6	-	0,060	0,085
14,0	21,0	4,2	-	0,070	0,100
16,0	24,0	4,8	-	0,080	0,115
18,0	27,0	5,4	-	0,090	0,130
20,0	30,0	6,0	-	0,100	0,140

Slot milling / Vollnutfräsen



Dc	Ap [1xD]	Ae [1xD]	fz
3,0	3,0	3,0	0,020
3,5	3,5	3,5	0,025
4,0	4,0	4,0	0,025
4,5	4,5	4,5	0,030
5,0	5,0	5,0	0,030
6,0	6,0	6,0	0,035
8,0	8,0	8,0	0,050
10,0	10,0	10,0	0,060
12,0	12,0	12,0	0,070
14,0	14,0	14,0	0,085
16,0	16,0	16,0	0,095
18,0	18,0	18,0	0,105
20,0	20,0	20,0	0,120

4 flute end mill; 40°-42° helix; DIN6527L; long length; AlCrN-based coated
 Schafffräser 4 Schneiden; 40°-42° Drallwinkel; DIN6527L; lange Ausführung; AlCrN-basierte Schicht

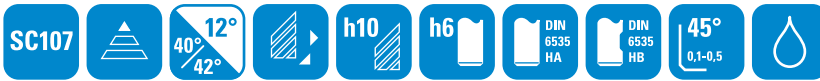
Specifications / Spezifikationen

DIN 6535 HA	DIN 6535 HB	Dc	Ds	Lc	Ln	Dn	Lt	r	z
BLC4L03042VN	BLW4L03042VN	3,0	6	8	14	2,8	57	-	4
BLC4L03542VN	BLW4L03542VN	3,5	6	10	16	3,3	57	-	4
BLC4L04042VN	BLW4L04042VN	4,0	6	11	16	3,8	57	-	4
BLC4L04542VN	BLW4L04542VN	4,5	6	11	18	4,3	57	-	4
BLC4L05042VN	BLW4L05042VN	5,0	6	13	18	4,8	57	-	4
BLC4L06042VN	BLW4L06042VN	6,0	6	13	19	5,7	57	-	4
BLC4L08042VN	BLW4L08042VN	8,0	8	19	25	7,6	63	-	4
BLC4L10042VN	BLW4L10042VN	10,0	10	22	30	9,5	72	-	4
BLC4L12042VN	BLW4L12042VN	12,0	12	26	36	11,5	83	-	4
BLC4L14042VN	BLW4L14042VN	14,0	14	26	36	13,5	83	-	4
BLC4L16042VN	BLW4L16042VN	16,0	16	32	42	15,5	92	-	4
BLC4L18042VN	BLW4L18042VN	18,0	18	32	42	17,5	92	-	4
BLC4L20042VN	BLW4L20042VN	20,0	20	38	52	19,5	104	-	4



4 flute torical end mill; 40°-42° helix; DIN6527L; long length; AlCr-based coated

Torusfräser 4 Schneiden; 40°-42° Drallwinkel; DIN6527L; lange Ausführung; AlCr-basierte Schicht

Workpiece material groups and cutting speed / Werkstoffgruppen und Schnittgeschwindigkeiten

Material Material	Tensile strength Zugfestigkeit Rm [N/mm ²]	Hardness Härte [HB/HRC]	Cutting speed Vc [m/min] Schnittgeschwindigkeiten		
			min	opt	max
P1 Plain carbon steel / Unlegierter Stahl	< 600	< 230	-	-	-
P2 Alloy Steel / Legierter Stahl	< 1200	< 350	-	-	-
P3 High alloy steel and tool steel / Hochlegierter Stahl und Werkzeugstahl	< 1400	< 380	-	-	-
M1 Aust. and Ferr. Stainless steel / Aust. und Ferr. rostfreie Stähle	< 680	< 220	90	120	150
M2 Mart. Stainless steel / Mart. rostfreie Stähle	< 820	< 240	70	100	130
K1 Grey cast iron / Grauguß	-	< 280	-	-	-
K2 Ductile cast iron / Sphäroguß	-	< 320	-	-	-
N1 Non-ferrous alloys / Nichteisenmetalle	< 250	< 110	-	-	-
N2 Aluminium alloys / Aluminiumlegierungen	< 530	< 130	-	-	-
S1 High temperature alloys Fe, Ni and Co based / Warmfeste Leg. Fe, Ni und Co	< 3300	< 350	60	70	80
S2 Titanium alloys; Alpha and Beta / Titan Legierungen Alpha und Beta	< 2100	< 400	80	90	100
H1 Hardened steel / Gehärtete Stähle	-	< 54 HRC	-	-	-
H2 Hardened steel / Gehärtete Stähle	-	52-60 HRC	-	-	-
H3 Hardened steel / Gehärtete Stähle	-	> 58 HRC	-	-	-
G1 Graphite / Graphit	-	-	-	-	-

Cutting conditions / Zerspanungswerte

Peripheral milling / Umfangfräsen



Dc	Ap [1.5xD]	Ae 1 [0.3xD]	Ae 2	fz 1 ▼▼	fz 2 ▼
6	9,0	1,8	-	0,015	0,025
8	12,0	2,4	-	0,015	0,025
10	15,0	3,0	-	0,020	0,030
12	18,0	3,6	-	0,020	0,035
16	24,0	4,8	-	0,025	0,035

Slot milling / Vollnutfräsen



Dc	Ap [1xD]	Ae [1xD]	fz
6	6,0	6	0,020
8	8,0	8	0,025
10	10,0	10	0,025
12	12,0	12	0,030
16	16,0	16	0,030

4 flute torical end mill; 40°-42° helix; DIN6527L; long length; AlCr-based coated
 Torusfräser 4 Schneiden; 40°-42° Drallwinkel; DIN6527L; lange Ausführung; AlCr-basierte Schicht

Specifications / Spezifikationen



NEW / NEU

DIN 6535 HA	DIN 6535 HB	Dc	Ds	Lc	Ln	Dn	Lt	r	z
BLC4L06042VNT05	BLW4L06042VNT05	6	6	13	19	5,7	57	0,5	4
BLC4L06042VNT10	BLW4L06042VNT10	6	6	13	19	5,7	57	1,0	4
BLC4L08042VNT05	BLW4L08042VNT05	8	8	19	25	7,6	63	0,5	4
BLC4L08042VNT10	BLW4L08042VNT10	8	8	19	25	7,6	63	1,0	4
BLC4L10042VNT05	BLW4L10042VNT05	10	10	22	30	9,5	72	0,5	4
BLC4L10042VNT10	BLW4L10042VNT10	10	10	22	30	9,5	72	1,0	4
BLC4L10042VNT20	BLW4L10042VNT20	10	10	22	30	9,5	72	2,0	4
BLC4L12042VNT05	BLW4L12042VNT05	12	12	26	36	11,5	83	0,5	4
BLC4L12042VNT10	BLW4L12042VNT10	12	12	26	36	11,5	83	1,0	4
BLC4L12042VNT20	BLW4L12042VNT20	12	12	26	36	11,5	83	2,0	4
BLC4L16042VNT05	BLW4L16042VNT05	16	16	32	42	15,5	92	0,5	4
BLC4L16042VNT10	BLW4L16042VNT10	16	16	32	42	15,5	92	1,0	4
BLC4L16042VNT20	BLW4L16042VNT20	16	16	32	42	15,5	92	2,0	4





BASICLINE
SOLID CARBIDE END MILLS®

PLUS+



Improving Quality Through Innovation

Product of Holland

UK D



PREMIUM LINE
SOLID CARBIDE END MILLS ®



- ▶ High performance tools / Hochleistungswerkzeuge
- ▶ Specific geometries / Spezifische Geometrien
- ▶ Edge preparation / Kantenpreparation
- ▶ Polished chip flute / Polierte Spannut
- ▶ Designed for large series production / Für Großserienfertigung



Improving Quality Through Innovation

Product of Holland

Table of contents

Inhaltsverzeichnis





















2 flute end mill; 30° helix; SCT norm; long reach; AlCrN coated Schafftfräser 2 Schneiden; 30° Drallwinkel; SCT Norm; abgesetzter Schaft; AlCrN beschichtet	4 - 5	
2 flute torical end mill; 30° helix; SCT norm; long reach; AlCrN coated Torusfräser 2 Schneiden; 30° Drallwinkel; SCT Norm; abgesetzter Schaft; AlCrN beschichtet	6 - 7	
3 flute end mill; 37°-38°-39° helix; SCT norm; short length; AlCrN coated Schafftfräser 3 Schneiden; 37°-38°-39° Drallwinkel; SCT Norm; kurze Ausführung; AlCrN beschichtet	8 - 9	
3 flute end mill; 37°-38°-39° helix; SCT norm; long length; AlCrN coated Schafftfräser 3 Schneiden; 37°-38°-39° Drallwinkel; SCT Norm; lange Ausführung; AlCrN beschichtet	10 - 11	
4 flute end mill; 44°-45° helix; SCT norm; long length; AlCrN coated Schafftfräser 4 Schneiden; 44°-45° Drallwinkel; SCT Norm; lange Ausführung; AlCrN beschichtet	12 - 13	
4 flute end mill; 55° helix; SCT norm; long length; AlCrN coated Schafftfräser 4 Schneiden; 55° Drallwinkel; SCT Norm; lange Ausführung; AlCrN beschichtet	14 - 15	
4 flute torical end mill; 44°-45° helix; SCT norm; long reach; AlCrN coated Torusfräser 4 Schneiden; 44°-45° Drallwinkel; SCT Norm; abgesetzter Schaft; AlCrN beschichtet	16 - 17	
Multi flute end mill; 50°-35° helix; SCT norm; long length; AlCrN coated Schafftfräser multi Schneiden; 50°-35° Drallwinkel; SCT Norm; lange Ausführung; AlCrN beschichtet	18 - 19	
Multi flute end mill; 50°-35° helix; SCT norm; XL length; AlCrN coated Schafftfräser multi Schneiden; 50°-35° Drallwinkel; SCT Norm; XL Ausführung; AlCrN beschichtet	20 - 21	
Multi flute torical end mill; 50°-35° helix; SCT norm; long reach; AlCrN coated Torusfräser multi Schneiden; 50°-35° Drallwinkel; SCT Norm; lange Ausführung; AlCrN beschichtet	22 - 23	
2 flute ball nose; 30° helix; SCT norm; long reach; AlCrN coated Radiusfräser 2 Schneiden; 30° Drallwinkel; SCT Norm; abgesetzter Schaft; AlCrN beschichtet	24 - 25	
4 flute ball nose; 30° helix; SCT norm; long reach; AlCrN coated Radiusfräser 4 Schneiden; 30° Drallwinkel; SCT Norm; abgesetzter Schaft; AlCrN beschichtet	26 - 27	
3 flute end mill; 54°-55°-56° helix; SCT norm; long length; AlCrN-based coated Schafftfräser 3 Schneiden; 54°-55°-56° Drallwinkel; SCT Norm; lange Ausführung; AlCrN-basierte Schicht	28 - 29	
4 flute end mill; 55° helix; SCT norm; long length; AlCrN-based coated Schafftfräser 4 Schneiden; 55° Drallwinkel; SCT Norm; lange Ausführung; AlCrN-basierte Schicht	30 - 31	
4 flute end mill; 55° helix; SCT norm; long reach; AlCrN-based coated Schafftfräser 4 Schneiden; 55° Drallwinkel; SCT Norm; abgesetzter Schaft; AlCrN-basierte Schicht	32 - 33	
3 flute rougher; 35°-36°-36° helix; SCT norm; long length; AlCrN-based coated Schafftfräser 3 Schneiden; 35°-36°-36° Drallwinkel; SCT Norm; lange Ausführung; AlCrN-basierte Schicht	34 - 35	
3 flute end mill; 44°-45°-46° helix; SCT norm; long length; CrN coated Schafftfräser 3 Schneiden; 44°-45°-46° Drallwinkel; SCT Norm; lange Ausführung; CrN beschichtet	36 - 37	

Table of contents
Inhaltsverzeichnis

<p>3 flute end mill; 44°-45°-46° helix; SCT norm; long reach; CrN coated Schaftfräser 3 Schneiden; 44°-45°-46° Drallwinkel; SCT Norm; abgesetzter Schaft; CrN beschichtet</p>	<p>38 - 39</p>	
<p>3 flute rougher; 35°-36°-36° helix; SCT norm; long length; CrN coated Schruppfräser 3 Schneiden; 35°-36°-36° Drallwinkel; SCT Norm; lange Ausführung; CrN beschichtet</p>	<p>40 - 41</p>	
<p>Multi flute fine pitch rougher; 25° helix; SCT norm; long length; CrN coated Schruppfräser Feinkordel multi Schneiden; 25° Drallwinkel; SCT Norm; lange Ausführung; CrN beschichtet</p>	<p>42 - 43</p>	
<p>3 flute ball nose; 44°-45°-46° helix; SCT norm; long reach; CrN coated Radiusfräser 3 Schneiden; 44°-45°-46° Drallwinkel; SCT Norm; abgesetzter Schaft; CrN beschichtet</p>	<p>44 - 45</p>	

2 flute end mill; 30° helix; SCT norm; long reach; AlCrN coated

Schafffräser 2 Schneiden; 30° Drallwinkel; SCT Norm; abgesetzter Schaft; AlCrN beschichtet

Workpiece material groups and cutting speed / Werkstoffgruppen und Schnittgeschwindigkeiten

Material Material	Tensile strength Zugfestigkeit Rm [N/mm ²]	Hardness Härte [HB/HRC]	Cutting speed Vc [m/min] Schnittgeschwindigkeiten		
			min	opt	max
P1 Plain carbon steel / Unlegierter Stahl	< 600	< 230	180	210	240
P2 Alloy Steel / Legierter Stahl	< 1200	< 350	150	175	200
P3 High alloy steel and tool steel / Hochlegierter Stahl und Werkzeugstahl	< 1400	< 380	100	120	140
M1 Aust. and Ferr. Stainless steel / Aust. und Ferr. rostfreie Stähle	< 680	< 220	-	-	-
M2 Mart. Stainless steel / Mart. rostfreie Stähle	< 820	< 240	-	-	-
K1 Grey cast iron / Grauguß	-	< 280	120	150	180
K2 Ductile cast iron / Sphäroguß	-	< 320	90	110	130
N1 Non-ferrous alloys / Nichteisenmetalle	< 250	< 110	-	-	-
N2 Aluminium alloys / Aluminiumlegierungen	< 530	< 130	-	-	-
S1 High temperature alloys Fe, Ni and Co based / Warmfeste Leg. Fe, Ni und Co	< 3300	< 350	40	50	60
S2 Titanium alloys; Alpha and Beta / Titan Legierungen Alpha und Beta	< 2100	< 400	60	70	80
H1 Hardened steel / Gehärtete Stähle	-	< 54 HRC	90	120	150
H2 Hardened steel / Gehärtete Stähle	-	52-60 HRC	70	100	130
H3 Hardened steel / Gehärtete Stähle	-	> 58 HRC	-	-	-
G1 Graphite / Graphit	-	-	-	-	-

Cutting conditions / Zerspanungswerte

Peripheral milling / Umfangfräsen



Dc	Ap [1xD]	Ae 1 [0.2xD]	Ae 2 [0.4xD]	fz 1 ▼▼	fz 2 ▼
2,0	2,0	0,4	0,8	0,008	0,012
2,5	2,5	0,5	1,0	0,010	0,015
3,0	3,0	0,6	1,2	0,012	0,018
3,5	3,5	0,7	1,4	0,014	0,021
4,0	4,0	0,8	1,6	0,016	0,024
4,5	4,5	0,9	1,8	0,018	0,027
5,0	5,0	1,0	2,0	0,020	0,030
5,5	5,5	1,1	2,2	0,022	0,033
6,0	6,0	1,2	2,4	0,024	0,036
7,0	7,0	1,4	2,8	0,028	0,042
8,0	8,0	1,6	3,2	0,032	0,048
9,0	9,0	1,8	3,6	0,036	0,054
10,0	10,0	2,0	4,0	0,040	0,060
11,0	11,0	2,2	4,4	0,044	0,066
12,0	12,0	2,4	4,8	0,048	0,072
13,0	13,0	2,6	5,2	0,052	0,078
14,0	14,0	2,8	5,6	0,056	0,084
15,0	15,0	3,0	6,0	0,060	0,090
16,0	16,0	3,2	6,4	0,064	0,096
18,0	18,0	3,6	7,2	0,072	0,108
20,0	20,0	4,0	8,0	0,080	0,120

Slot milling / Vollnutfräsen



Dc	Ap [0.25xD]	Ae [1xD]	fz
2,0	0,5	2,0	0,006
2,5	0,6	2,5	0,008
3,0	0,8	3,0	0,009
3,5	0,9	3,5	0,011
4,0	1,0	4,0	0,012
4,5	1,1	4,5	0,014
5,0	1,3	5,0	0,015
5,5	1,4	5,5	0,017
6,0	1,5	6,0	0,018
7,0	1,8	7,0	0,021
8,0	2,0	8,0	0,024
9,0	2,3	9,0	0,027
10,0	2,5	10,0	0,030
11,0	2,8	11,0	0,033
12,0	3,0	12,0	0,036
13,0	3,3	13,0	0,039
14,0	3,5	14,0	0,042
15,0	3,8	15,0	0,045
16,0	4,0	16,0	0,048
18,0	4,5	18,0	0,054
20,0	5,0	20,0	0,060

2 flute end mill; 30° helix; SCT norm; long reach; AlCrN coated
Schaftfräser 2 Schneiden; 30° Drallwinkel; SCT Norm; abgesetzter Schaft; AlCrN beschichtet
Specifications / Spezifikationen

DIN 6535 HA	DIN 6535 HB	Dc	Ds	Lc	Ln	Dn	Lt	r	z
PLSC2X02030S	PLSW2X02030S	2,0	6	3	9	1,8	54	-	2
PLSC2X02530S	PLSW2X02530S	2,5	6	3,5	9	2,2	54	-	2
PLSC2X03030S	PLSW2X03030S	3,0	6	4	11	2,7	54	-	2
PLSC2X03530S	PLSW2X03530S	3,5	6	4,5	11	3,1	57	-	2
PLSC2X04030S	PLSW2X04030S	4,0	6	5	15	3,6	57	-	2
PLSC2X04530S	PLSW2X04530S	4,5	6	5,5	15	4,1	57	-	2
PLSC2X05030S	PLSW2X05030S	5,0	6	6	23	4,5	62	-	2
PLSC2X05530S	PLSW2X05530S	5,5	6	6,5	23	5,0	62	-	2
PLSC2X06030S	PLSW2X06030S	6,0	6	7	24	5,4	62	-	2
PLSC2X07030S	PLSW2X07030S	7,0	8	8	28	6,3	68	-	2
PLSC2X08030S	PLSW2X08030S	8,0	8	9	30	7,2	68	-	2
PLSC2X09030S	PLSW2X09030S	9,0	10	10	36	8,2	80	-	2
PLSC2X10030S	PLSW2X10030S	10,0	10	11	38	9,0	80	-	2
PLSC2X11030S	PLSW2X11030S	11,0	12	12	44	10,0	93	-	2
PLSC2X12030S	PLSW2X12030S	12,0	12	13	46	11,0	93	-	2
PLSC2X13030S	PLSW2X13030S	13,0	14	14	44	12,0	93	-	2
PLSC2X14030S	PLSW2X14030S	14,0	14	15	46	13,0	93	-	2
PLSC2X15030S	PLSW2X15030S	15,0	16	16	56	14,0	108	-	2
PLSC2X16030S	PLSW2X16030S	16,0	16	17	58	15,0	108	-	2
PLSC2X18030S	PLSW2X18030S	18,0	18	19	58	17,0	108	-	2
PLSC2X20030S	PLSW2X20030S	20,0	20	21	74	19,0	126	-	2



2 flute torical end mill; 30° helix; SCT norm; long reach; AlCrN coated

Torusfräser 2 Schneiden; 30° Drallwinkel; SCT Norm; abgesetzter Schaft; AlCrN beschichtet

Workpiece material groups and cutting speed / Werkstoffgruppen und Schnittgeschwindigkeiten

Material Material	Tensile strength Zugfestigkeit Rm [N/mm ²]	Hardness Härte [HB/HRC]	Cutting speed Vc [m/min] Schnittgeschwindigkeiten		
			min	opt	max
P1 Plain carbon steel / Unlegierter Stahl	< 600	< 230	180	210	240
P2 Alloy Steel / Legierter Stahl	< 1200	< 350	150	175	200
P3 High alloy steel and tool steel / Hochlegierter Stahl und Werkzeugstahl	< 1400	< 380	100	120	140
M1 Aust. and Ferr. Stainless steel / Aust. und Ferr. rostfreie Stähle	< 680	< 220	-	-	-
M2 Mart. Stainless steel / Mart. rostfreie Stähle	< 820	< 240	-	-	-
K1 Grey cast iron / Grauguß	-	< 280	120	150	180
K2 Ductile cast iron / Sphäroguß	-	< 320	90	110	130
N1 Non-ferrous alloys / Nichteisenmetalle	< 250	< 110	-	-	-
N2 Aluminium alloys / Aluminiumlegierungen	< 530	< 130	-	-	-
S1 High temperature alloys Fe, Ni and Co based / Warmfeste Leg. Fe, Ni und Co	< 3300	< 350	40	50	60
S2 Titanium alloys; Alpha and Beta / Titan Legierungen Alpha und Beta	< 2100	< 400	60	70	80
H1 Hardened steel / Gehärtete Stähle	-	< 54 HRC	90	120	150
H2 Hardened steel / Gehärtete Stähle	-	52-60 HRC	70	100	130
H3 Hardened steel / Gehärtete Stähle	-	> 58 HRC	-	-	-
G1 Graphite / Graphit	-	-	-	-	-

Cutting conditions / Zerspanungswerte

Peripheral milling / Umfangfräsen



Dc	Ap [1xD]	Ae 1 [0.2xD]	Ae 2 [0.4xD]	fz 1 ▼▼	fz 2 ▼
4,0	4,0	0,8	1,6	0,02	0,030
6,0	6,0	1,2	2,4	0,03	0,045
8,0	8,0	1,6	3,2	0,04	0,060
10,0	10,0	2,0	4,0	0,05	0,075
12,0	12,0	2,4	4,8	0,06	0,090
16,0	16,0	3,2	6,4	0,08	0,120

Slot milling / Vollnutfräsen



Dc	Ap [0.25xD]	Ae [1xD]	fz
4,0	1,0	4,0	0,013
6,0	1,5	6,0	0,020
8,0	2,0	8,0	0,026
10,0	2,5	10,0	0,033
12,0	3,0	12,0	0,039
16,0	4,0	16,0	0,052

2 flute torical end mill; 30° helix; SCT norm; long reach; AlCrN coated
Torusfräser 2 Schneiden; 30° Drallwinkel; SCT Norm; abgesetzter Schaft; AlCrN beschichtet
Specifications / Spezifikationen

DIN 6535 HA	DIN 6535 HB	Dc	Ds	Lc	Ln	Dn	Lt	r	z
PLSC2X04030T03	PLSW2X04030T03	4,0	6	5	16	3,6	57	0,3	2
PLSC2X04030T05	PLSW2X04030T05	4,0	6	5	16	3,6	57	0,5	2
PLSC2X06030T03	PLSW2X06030T03	6,0	6	7	24	5,4	62	0,3	2
PLSC2X06030T05	PLSW2X06030T05	6,0	6	7	24	5,4	62	0,5	2
PLSC2X06030T10	PLSW2X06030T10	6,0	6	7	24	5,4	62	1,0	2
PLSC2X06030T15	PLSW2X06030T15	6,0	6	7	24	5,4	62	1,5	2
PLSC2X08030T03	PLSW2X08030T03	8,0	8	9	30	7,2	68	0,3	2
PLSC2X08030T05	PLSW2X08030T05	8,0	8	9	30	7,2	68	0,5	2
PLSC2X08030T10	PLSW2X08030T10	8,0	8	9	30	7,2	68	1,0	2
PLSC2X08030T15	PLSW2X08030T15	8,0	8	9	30	7,2	68	1,5	2
PLSC2X10030T05	PLSW2X10030T05	10,0	10	11	38	9,0	80	0,5	2
PLSC2X10030T10	PLSW2X10030T10	10,0	10	11	38	9,0	80	1,0	2
PLSC2X10030T15	PLSW2X10030T15	10,0	10	11	38	9,0	80	1,5	2
PLSC2X10030T20	PLSW2X10030T20	10,0	10	11	38	9,0	80	2,0	2
PLSC2X12030T05	PLSW2X12030T05	12,0	12	13	46	11,0	93	0,5	2
PLSC2X12030T10	PLSW2X12030T10	12,0	12	13	46	11,0	93	1,0	2
PLSC2X12030T15	PLSW2X12030T15	12,0	12	13	46	11,0	93	1,5	2
PLSC2X12030T20	PLSW2X12030T20	12,0	12	13	46	11,0	93	2,0	2
PLSC2X16030T10	PLSW2X16030T10	16,0	16	17	58	15,0	108	1,0	2
PLSC2X16030T20	PLSW2X16030T20	16,0	16	17	58	15,0	108	2,0	2
PLSC2X16030T30	PLSW2X16030T30	16,0	16	17	58	15,0	108	3,0	2
PLSC2X16030T40	PLSW2X16030T40	16,0	16	17	58	15,0	108	4,0	2



3 flute end mill; 37°-38°-39° helix; SCT norm; short length; AlCrN coated

Schaftfräser 3 Schneiden; 37°-38°-39° Drallwinkel; SCT Norm; kurze Ausführung; AlCrN beschichtet

Workpiece material groups and cutting speed / Werkstoffgruppen und Schnittgeschwindigkeiten

Material Material	Tensile strength Zugfestigkeit Rm [N/mm ²]	Hardness Härte [HB/HRC]	Cutting speed Vc [m/min] Schnittgeschwindigkeiten		
			min	opt	max
P1 Plain carbon steel / Unlegierter Stahl	< 600	< 230	180	210	240
P2 Alloy Steel / Legierter Stahl	< 1200	< 350	150	175	200
P3 High alloy steel and tool steel / Hochlegierter Stahl und Werkzeugstahl	< 1400	< 380	100	120	140
M1 Aust. and Ferr. Stainless steel / Aust. und Ferr. rostfreie Stähle	< 680	< 220	-	-	-
M2 Mart. Stainless steel / Mart. rostfreie Stähle	< 820	< 240	-	-	-
K1 Grey cast iron / Grauguß	-	< 280	120	150	180
K2 Ductile cast iron / Sphäroguß	-	< 320	90	110	130
N1 Non-ferrous alloys / Nichteisenmetalle	< 250	< 110	-	-	-
N2 Aluminium alloys / Aluminiumlegierungen	< 530	< 130	-	-	-
S1 High temperature alloys Fe, Ni and Co based / Warmfeste Leg. Fe, Ni und Co	< 3300	< 350	40	50	60
S2 Titanium alloys; Alpha and Beta / Titan Legierungen Alpha und Beta	< 2100	< 400	60	70	80
H1 Hardened steel / Gehärtete Stähle	-	< 54 HRC	90	120	150
H2 Hardened steel / Gehärtete Stähle	-	52-60 HRC	70	100	130
H3 Hardened steel / Gehärtete Stähle	-	> 58 HRC	-	-	-
G1 Graphite / Graphit	-	-	-	-	-

Cutting conditions / Zerspanungswerte

Peripheral milling / Umfangfräsen



Dc	Ap [1xD]	Ae 1 [0.2xD]	Ae 2 [0.4xD]	fz 1 ▼▼	fz 2 ▼
3,0	3,0	0,6	1,2	0,015	0,025
3,5	3,5	0,7	1,4	0,018	0,029
4,0	4,0	0,8	1,6	0,020	0,033
4,5	4,5	0,9	1,8	0,023	0,037
5,0	5,0	1,0	2,0	0,025	0,042
5,5	5,5	1,1	2,2	0,028	0,046
6,0	6,0	1,2	2,4	0,030	0,050
8,0	8,0	1,6	3,2	0,040	0,066
10,0	10,0	2,0	4,0	0,050	0,083
12,0	12,0	2,4	4,8	0,060	0,100
14,0	14,0	3,2	6,4	0,070	0,116
16,0	16,0	3,4	6,8	0,080	0,133
18,0	18,0	3,6	7,2	0,090	0,149
20,0	20,0	4,0	8,0	0,100	0,166

Slot milling / Vollnutfräsen



Dc	Ap [0.2xD]	Ae [1xD]	fz
3,0	0,6	3,0	0,009
3,5	0,7	3,5	0,011
4,0	0,8	4,0	0,012
4,5	0,9	4,5	0,014
5,0	1,0	5,0	0,015
5,5	1,1	5,5	0,017
6,0	1,2	6,0	0,018
8,0	1,6	8,0	0,024
10,0	2,0	10,0	0,030
12,0	2,4	12,0	0,036
14,0	2,8	14,0	0,042
16,0	3,2	16,0	0,048
18,0	3,6	18,0	0,054
20,0	4,0	20,0	0,060

3 flute end mill; 37°-38°-39° helix; SCT norm; short length; AlCrN coated
 Schafffräser 3 Schneiden; 37°-38°-39° Drallwinkel; SCT Norm; kurze Ausführung; AlCrN beschichtet

Specifications / Spezifikationen

DIN 6535 HA	DIN 6535 HB	Dc	Ds	Lc	Ln	Dn	Lt	r	z
PLSC3S03038V	PLSW3S03038V	3,0	6	5	-	-	50	-	3
PLSC3S03538V	PLSW3S03538V	3,5	6	6	-	-	50	-	3
PLSC3S04038V	PLSW3S04038V	4,0	6	8	13	3,8	54	-	3
PLSC3S04538V	PLSW3S04538V	4,5	6	8	13	4,3	54	-	3
PLSC3S05038V	PLSW3S05038V	5,0	6	9	15	4,8	54	-	3
PLSC3S05538V	PLSW3S05538V	5,5	6	9	15	5,3	54	-	3
PLSC3S06038V	PLSW3S06038V	6,0	6	10	16	5,7	54	-	3
PLSC3S08038V	PLSW3S08038V	8,0	8	12	20	7,6	58	-	3
PLSC3S10038V	PLSW3S10038V	10,0	10	14	24	9,5	66	-	3
PLSC3S12038V	PLSW3S12038V	12,0	12	16	26	11,5	73	-	3
PLSC3S14038V	PLSW3S14038V	14,0	14	16	26	13,5	73	-	3
PLSC3S16038V	PLSW3S16038V	16,0	16	22	32	15,5	82	-	3
PLSC3S18038V	PLSW3S18038V	18,0	18	22	32	17,5	82	-	3
PLSC3S20038V	PLSW3S20038V	20,0	20	26	40	19,5	92	-	3



3 flute end mill; 37°-38°-39° helix; SCT norm; long length; AlCrN coated

Schaftfräser 3 Schneiden; 37°-38°-39° Drallwinkel; SCT Norm; lange Ausführung; AlCrN beschichtet

Workpiece material groups and cutting speed / Werkstoffgruppen und Schnittgeschwindigkeiten

Material Material	Tensile strength Zugfestigkeit Rm [N/mm ²]	Hardness Härte [HB/HRC]	Cutting speed Vc [m/min] Schnittgeschwindigkeiten		
			min	opt	max
P1 Plain carbon steel / Unlegierter Stahl	< 600	< 230	180	210	240
P2 Alloy Steel / Legierter Stahl	< 1200	< 350	150	175	200
P3 High alloy steel and tool steel / Hochlegierter Stahl und Werkzeugstahl	< 1400	< 380	100	120	140
M1 Aust. and Ferr. Stainless steel / Aust. und Ferr. rostfreie Stähle	< 680	< 220	-	-	-
M2 Mart. Stainless steel / Mart. rostfreie Stähle	< 820	< 240	-	-	-
K1 Grey cast iron / Grauguß	-	< 280	120	150	180
K2 Ductile cast iron / Sphäroguß	-	< 320	90	110	130
N1 Non-ferrous alloys / Nichteisenmetalle	< 250	< 110	-	-	-
N2 Aluminium alloys / Aluminiumlegierungen	< 530	< 130	-	-	-
S1 High temperature alloys Fe, Ni and Co based / Warmfeste Leg. Fe, Ni und Co	< 3300	< 350	40	50	60
S2 Titanium alloys; Alpha and Beta / Titan Legierungen Alpha und Beta	< 2100	< 400	60	70	80
H1 Hardened steel / Gehärtete Stähle	-	< 54 HRC	90	120	150
H2 Hardened steel / Gehärtete Stähle	-	52-60 HRC	70	100	130
H3 Hardened steel / Gehärtete Stähle	-	> 58 HRC	-	-	-
G1 Graphite / Graphit	-	-	-	-	-

Cutting conditions / Zerspanungswerte

Peripheral milling / Umfangfräsen



Dc	Ap [1xD]	Ae 1 [0.1xD]	Ae 2 [0.4xD]	fz 1 ▼▼	fz 2 ▼
3,0	3,0	0,30	1,2	0,015	0,025
3,5	3,5	0,35	1,4	0,018	0,029
4,0	4,0	0,40	1,6	0,020	0,033
4,5	4,5	0,45	1,8	0,023	0,037
5,0	5,0	0,50	2,0	0,025	0,042
5,5	5,5	0,55	2,2	0,028	0,046
6,0	6,0	0,60	2,4	0,030	0,050
8,0	8,0	0,80	3,2	0,040	0,066
10,0	10,0	1,00	4,0	0,050	0,083
12,0	12,0	1,20	4,8	0,060	0,100
14,0	14,0	1,40	5,6	0,070	0,116
16,0	16,0	1,60	6,4	0,080	0,133
18,0	18,0	1,80	7,2	0,090	0,149
20,0	20,0	2,00	8,0	0,100	0,166

Slot milling / Vollnutfräsen



Dc	Ap [0.25xD]	Ae [1xD]	fz
3,0	0,8	3,0	0,013
3,5	0,9	3,5	0,015
4,0	1,0	4,0	0,017
4,5	1,1	4,5	0,019
5,0	1,3	5,0	0,022
5,5	1,4	5,5	0,024
6,0	1,5	6,0	0,026
8,0	2,0	8,0	0,035
10,0	2,5	10,0	0,043
12,0	3,0	12,0	0,052
14,0	3,5	14,0	0,061
16,0	4,0	16,0	0,069
18,0	4,5	18,0	0,078
20,0	5,0	20,0	0,087

3 flute end mill; 37°-38°-39° helix; SCT norm; long length; AlCrN coated
 Schafffräser 3 Schneiden; 37°-38°-39° Drallwinkel; SCT Norm; lange Ausführung; AlCrN beschichtet

Specifications / Spezifikationen

DIN 6535 HA	DIN 6535 HB	Dc	Ds	Lc	Ln	Dn	Lt	r	z
PLSC3L03038V	PLSW3L03038V	3,0	6	8	14	2,8	57	-	3
PLSC3L03538V	PLSW3L03538V	3,5	6	8	14	3,3	57	-	3
PLSC3L04038V	PLSW3L04038V	4,0	6	11	16	3,8	57	-	3
PLSC3L04538V	PLSW3L04538V	4,5	6	11	16	4,3	57	-	3
PLSC3L05038V	PLSW3L05038V	5,0	6	13	18	4,8	57	-	3
PLSC3L05538V	PLSW3L05538V	5,5	6	13	18	5,3	57	-	3
PLSC3L06038V	PLSW3L06038V	6,0	6	13	19	5,7	57	-	3
PLSC3L08038V	PLSW3L08038V	8,0	8	19	25	7,6	63	-	3
PLSC3L10038V	PLSW3L10038V	10,0	10	22	30	9,5	72	-	3
PLSC3L12038V	PLSW3L12038V	12,0	12	26	36	11,5	83	-	3
PLSC3L14038V	PLSW3L14038V	14,0	14	26	36	13,5	83	-	3
PLSC3L16038V	PLSW3L16038V	16,0	16	32	42	15,5	92	-	3
PLSC3L18038V	PLSW3L18038V	18,0	18	32	42	17,5	92	-	3
PLSC3L20038V	PLSW3L20038V	20,0	20	38	52	19,5	104	-	3



4 flute end mill; 44°-45° helix; SCT norm; long length; AlCrN coated

Schafffräser 4 Schneiden; 44°-45° Drallwinkel; SCT Norm; lange Ausführung; AlCrN beschichtet

Workpiece material groups and cutting speed / Werkstoffgruppen und Schnittgeschwindigkeiten

Material Material	Tensile strength Zugfestigkeit Rm [N/mm ²]	Hardness Härte [HB/HRC]	Cutting speed Vc [m/min] Schnittgeschwindigkeiten		
			min	opt	max
P1 Plain carbon steel / Unlegierter Stahl	< 600	< 230	180	210	240
P2 Alloy Steel / Legierter Stahl	< 1200	< 350	150	175	200
P3 High alloy steel and tool steel / Hochlegierter Stahl und Werkzeugstahl	< 1400	< 380	100	120	140
M1 Aust. and Ferr. Stainless steel / Aust. und Ferr. rostfreie Stähle	< 680	< 220	-	-	-
M2 Mart. Stainless steel / Mart. rostfreie Stähle	< 820	< 240	-	-	-
K1 Grey cast iron / Grauguß	-	< 280	120	150	180
K2 Ductile cast iron / Sphäroguß	-	< 320	90	110	130
N1 Non-ferrous alloys / Nichteisenmetalle	< 250	< 110	-	-	-
N2 Aluminium alloys / Aluminiumlegierungen	< 530	< 130	-	-	-
S1 High temperature alloys Fe, Ni and Co based / Warmfeste Leg. Fe, Ni und Co	< 3300	< 350	40	50	60
S2 Titanium alloys; Alpha and Beta / Titan Legierungen Alpha und Beta	< 2100	< 400	60	70	80
H1 Hardened steel / Gehärtete Stähle	-	< 54 HRC	90	120	150
H2 Hardened steel / Gehärtete Stähle	-	52-60 HRC	70	100	130
H3 Hardened steel / Gehärtete Stähle	-	> 58 HRC	-	-	-
G1 Graphite / Graphit	-	-	-	-	-

Cutting conditions / Zerspanungswerte

Peripheral milling / Umfangfräsen



Dc	Ap [1xD]	Ae 1 [0.2xD]	Ae 2 [0.4xD]	fz 1 ▼▼	fz 2 ▼
3,0	3,0	0,6	1,2	0,015	0,025
3,5	3,5	0,7	1,4	0,018	0,029
4,0	4,0	0,8	1,6	0,020	0,033
4,5	4,5	0,9	1,8	0,023	0,037
5,0	5,0	1,0	2,0	0,025	0,042
5,5	5,5	1,1	2,2	0,028	0,046
6,0	6,0	1,2	2,4	0,030	0,050
8,0	8,0	1,6	3,2	0,040	0,066
10,0	10,0	2,0	4,0	0,050	0,083
12,0	12,0	2,4	4,8	0,060	0,100
14,0	14,0	2,8	5,6	0,070	0,116
16,0	16,0	3,2	6,4	0,080	0,133
18,0	18,0	3,6	7,2	0,090	0,149
20,0	20,0	4,0	8,0	0,100	0,166
25,0	25,0	5,0	10,0	0,125	0,208

Slot milling / Vollnutfräsen



Dc	Ap [0.25xD]	Ae [1xD]	fz
3,0	0,8	3,0	0,009
3,5	0,9	3,5	0,011
4,0	1,0	4,0	0,012
4,5	1,1	4,5	0,014
5,0	1,3	5,0	0,015
5,5	1,4	5,5	0,017
6,0	1,5	6,0	0,018
8,0	2,0	8,0	0,024
10,0	2,5	10,0	0,030
12,0	3,0	12,0	0,036
14,0	3,5	14,0	0,042
16,0	4,0	16,0	0,048
18,0	4,5	18,0	0,054
20,0	5,0	20,0	0,060
25,0	6,3	25,0	0,075

4 flute end mill; 44°-45° helix; SCT norm; long length; AlCrN coated
 Schafffräser 4 Schneiden; 44°-45° Drallwinkel; SCT Norm; lange Ausführung; AlCrN beschichtet

Specifications / Spezifikationen

DIN 6535 HA	DIN 6535 HB	Dc	Ds	Lc	Ln	Dn	Lt	r	z
PLSC4L03045V	PLSW4L03045V	3,0	6	8	14	2,8	57	-	4
PLSC4L03545V	PLSW4L03545V	3,5	6	11	16	3,3	57	-	4
PLSC4L04045V	PLSW4L04045V	4,0	6	11	16	3,8	57	-	4
PLSC4L04545V	PLSW4L04545V	4,5	6	13	18	4,3	57	-	4
PLSC4L05045V	PLSW4L05045V	5,0	6	13	18	4,8	57	-	4
PLSC4L05545V	PLSW4L05545V	5,5	6	13	18	5,3	57	-	4
PLSC4L06045V	PLSW4L06045V	6,0	6	13	19	5,7	57	-	4
PLSC4L08045V	PLSW4L08045V	8,0	8	19	25	7,6	63	-	4
PLSC4L10045V	PLSW4L10045V	10,0	10	22	30	9,5	72	-	4
PLSC4L12045V	PLSW4L12045V	12,0	12	26	36	11,5	83	-	4
PLSC4L14045V	PLSW4L14045V	14,0	14	26	36	13,5	83	-	4
PLSC4L16045V	PLSW4L16045V	16,0	16	32	42	15,5	92	-	4
PLSC4L18045V	PLSW4L18045V	18,0	18	32	42	17,5	92	-	4
PLSC4L20045V	PLSW4L20045V	20,0	20	38	52	19,5	104	-	4
PLSC4L25045V	PLSW4L25045V	25,0	25	45	62	24,0	120	-	4



4 flute end mill; 55° helix; SCT norm; long length; AlCrN coated

Schaftfräser 4 Schneiden; 55° Drallwinkel; SCT Norm; lange Ausführung; AlCrN beschichtet

Workpiece material groups and cutting speed / Werkstoffgruppen und Schnittgeschwindigkeiten

Material Material	Tensile strength Zugfestigkeit Rm [N/mm ²]	Hardness Härte [HB/HRC]	Cutting speed Vc [m/min] Schnittgeschwindigkeiten		
			min	opt	max
P1 Plain carbon steel / Unlegierter Stahl	< 600	< 230	180	210	240
P2 Alloy Steel / Legierter Stahl	< 1200	< 350	150	175	200
P3 High alloy steel and tool steel / Hochlegierter Stahl und Werkzeugstahl	< 1400	< 380	100	120	140
M1 Aust. and Ferr. Stainless steel / Aust. und Ferr. rostfreie Stähle	< 680	< 220	-	-	-
M2 Mart. Stainless steel / Mart. rostfreie Stähle	< 820	< 240	-	-	-
K1 Grey cast iron / Grauguß	-	< 280	120	150	180
K2 Ductile cast iron / Sphäroguß	-	< 320	90	110	130
N1 Non-ferrous alloys / Nichteisenmetalle	< 250	< 110	-	-	-
N2 Aluminium alloys / Aluminiumlegierungen	< 530	< 130	-	-	-
S1 High temperature alloys Fe, Ni and Co based / Warmfeste Leg. Fe, Ni und Co	< 3300	< 350	40	50	60
S2 Titanium alloys; Alpha and Beta / Titan Legierungen Alpha und Beta	< 2100	< 400	60	70	80
H1 Hardened steel / Gehärtete Stähle	-	< 54 HRC	90	120	150
H2 Hardened steel / Gehärtete Stähle	-	52-60 HRC	70	100	130
H3 Hardened steel / Gehärtete Stähle	-	> 58 HRC	-	-	-
G1 Graphite / Graphit	-	-	-	-	-

Cutting conditions / Zerspanungswerte

Peripheral milling / Umfangfräsen



Dc	Ap [1xD]	Ae 1 [0.25xD]	Ae 2 [0.5xD]	fz 1 ▼▼	fz 2 ▼
4,0	4,0	1,0	2,0	0,015	0,020
5,0	5,0	1,3	2,5	0,019	0,025
6,0	6,0	1,5	3,0	0,023	0,030
8,0	8,0	2,0	4,0	0,030	0,040
10,0	10,0	2,5	5,0	0,038	0,050
12,0	12,0	3,0	6,0	0,045	0,060
14,0	14,0	3,5	7,0	0,053	0,070
16,0	16,0	4,0	8,0	0,060	0,080
18,0	18,0	4,5	9,0	0,068	0,090
20,0	20,0	5,0	10,0	0,075	0,100

Slot milling / Vollnutfräsen



Dc	Ap [1xD]	Ae [1xD]	fz
4,0	4,0	4,0	0,015
5,0	5,0	5,0	0,019
6,0	6,0	6,0	0,023
8,0	8,0	8,0	0,030
10,0	10,0	10,0	0,038
12,0	12,0	12,0	0,045
14,0	14,0	14,0	0,053
16,0	16,0	16,0	0,060
18,0	18,0	18,0	0,068
20,0	20,0	20,0	0,075

4 flute end mill; 55° helix; SCT norm; long length; AlCrN coated
 Schaftfräser 4 Schneiden; 55° Drallwinkel; SCT Norm; lange Ausführung; AlCrN beschichtet

Specifications / Spezifikationen



DIN 6535 HA	DIN 6535 HB	Dc	Ds	Lc	Ln	Dn	Lt	r	z
PLSC4L04055S	PLSW4L04055S	4,0	6	11	16	3,7	57	-	4
PLSC4L05055S	PLSW4L05055S	5,0	6	13	18	4,7	57	-	4
PLSC4L06055S	PLSW4L06055S	6,0	6	13	19	5,7	57	-	4
PLSC4L08055S	PLSW4L08055S	8,0	8	19	25	7,6	63	-	4
PLSC4L10055S	PLSW4L10055S	10,0	10	22	30	9,5	72	-	4
PLSC4L12055S	PLSW4L12055S	12,0	12	26	36	11,5	83	-	4
PLSC4L14055S	PLSW4L14055S	14,0	14	26	36	13,5	83	-	4
PLSC4L16055S	PLSW4L16055S	16,0	16	32	42	15,5	92	-	4
PLSC4L18055S	PLSW4L18055S	18,0	18	32	42	17,5	92	-	4
PLSC4L20055S	PLSW4L20055S	20,0	20	38	52	19,5	104	-	4



4 flute torical end mill; 44°-45° helix; SCT norm; long reach; ALCrN coated
Torusfräser 4 Schneiden; 44°-45° Drallwinkel; SCT Norm; abgesetzter Schaft; AlCrN beschichtet
Specifications / Spezifikationen

DIN 6535 HA	DIN 6535 HB	Dc	Ds	Lc	Ln	Dn	Lt	r	z
PLSC4X04045T03	PLSW4X04045T03	4,0	6	5	16	3,6	57	0,3	4
PLSC4X04045T05	PLSW4X04045T05	4,0	6	5	16	3,6	57	0,5	4
PLSC4X06045T03	PLSW4X06045T03	6,0	6	7	24	5,4	62	0,3	4
PLSC4X06045T05	PLSW4X06045T05	6,0	6	7	24	5,4	62	0,5	4
PLSC4X06045T10	PLSW4X06045T10	6,0	6	7	24	5,4	62	1,0	4
PLSC4X06045T15	PLSW4X06045T15	6,0	6	7	24	5,4	62	1,5	4
PLSC4X08045T03	PLSW4X08045T03	8,0	8	9	30	7,2	68	0,3	4
PLSC4X08045T05	PLSW4X08045T05	8,0	8	9	30	7,2	68	0,5	4
PLSC4X08045T10	PLSW4X08045T10	8,0	8	9	30	7,2	68	1,0	4
PLSC4X08045T15	PLSW4X08045T15	8,0	8	9	30	7,2	68	1,5	4
PLSC4X10045T05	PLSW4X10045T05	10,0	10	11	38	9,0	80	0,5	4
PLSC4X10045T10	PLSW4X10045T10	10,0	10	11	38	9,0	80	1,0	4
PLSC4X10045T15	PLSW4X10045T15	10,0	10	11	38	9,0	80	1,5	4
PLSC4X10045T20	PLSW4X10045T20	10,0	10	11	38	9,0	80	2,0	4
PLSC4X12045T05	PLSW4X12045T05	12,0	12	13	46	11,0	93	0,5	4
PLSC4X12045T10	PLSW4X12045T10	12,0	12	13	46	11,0	93	1,0	4
PLSC4X12045T15	PLSW4X12045T15	12,0	12	13	46	11,0	93	1,5	4
PLSC4X12045T20	PLSW4X12045T20	12,0	12	13	46	11,0	93	2,0	4
PLSC4X16045T10	PLSW4X16045T10	16,0	16	17	58	15,0	108	1,0	4
PLSC4X16045T20	PLSW4X16045T20	16,0	16	17	58	15,0	108	2,0	4
PLSC4X16045T30	PLSW4X16045T30	16,0	16	17	58	15,0	108	3,0	4
PLSC4X16045T40	PLSW4X16045T40	16,0	16	17	58	15,0	108	4,0	4



Multi flute end mill; 50°-35° helix; SCT norm; long length; AlCrN coated
 Schafffräser multi Schneiden; 50°-35° Drallwinkel; SCT Norm; lange Ausführung; AlCrN beschichtet

Specifications / Spezifikationen



DIN 6535 HA	DIN 6535 HB	Dc	Ds	Lc	Ln	Dn	Lt	r	z
PLSC6L06050S	PLSW6L06050S	6,0	6	13	-	-	57	-	6
PLSC6L08050S	PLSW6L08050S	8,0	8	19	-	-	63	-	6
PLSC6L10050S	PLSW6L10050S	10,0	10	22	-	-	72	-	6
PLSC6L12050S	PLSW6L12050S	12,0	12	26	-	-	83	-	6
PLSC6L14050S	PLSW6L14050S	14,0	14	26	-	-	83	-	6
PLSC6L16050S	PLSW6L16050S	16,0	16	32	-	-	92	-	6
PLSC8L18050S	PLSW8L18050S	18,0	18	32	-	-	92	-	8
PLSC8L20050S	PLSW8L20050S	20,0	20	38	-	-	104	-	8
PLSC8L25050S	PLSW8L25050S	25,0	25	45	-	-	120	-	8



Multi flute end mill; 50°-35° helix; SCT norm; XL length; AlCrN coated
 Schaftfräser multi Schneiden; 50°-35° Drallwinkel; SCT Norm; XL Ausführung; AlCrN beschichtet

Specifications / Spezifikationen



DIN 6535 HA	DIN 6535 HB	Dc	Ds	Lc	Ln	Dn	Lt	r	z
PLSC6X06050S	PLSW6X06050S	6,0	6	18	-	-	62	-	6
PLSC6X08050S	PLSW6X08050S	8,0	8	24	-	-	68	-	6
PLSC6X10050S	PLSW6X10050S	10,0	10	30	-	-	80	-	6
PLSC6X12050S	PLSW6X12050S	12,0	12	36	-	-	93	-	6
PLSC6X16050S	PLSW6X16050S	16,0	16	48	-	-	108	-	6
PLSC8X20050S	PLSW8X20050S	20,0	20	60	-	-	126	-	8
PLSC8X25050S	PLSW8X25050S	25,0	25	85	-	-	150	-	8



Multi flute torical end mill; 50°-35° helix; SCT norm; long reach; AlCrN coated
Torusfräser multi Schneiden; 50°-35° Drallwinkel; SCT Norm; lange Ausführung; AlCrN beschichtet
Specifications / Spezifikationen

DIN 6535 HA	DIN 6535 HB	Dc	Ds	Lc	Ln	Dn	Lt	r	z
PLSC6X06050T05	PLSW6X06050T05	6,0	6	13	-	-	62	0,5	6
PLSC6X06050T10	PLSW6X06050T10	6,0	6	13	-	-	62	1,0	6
PLSC6X08050T05	PLSW6X08050T05	8,0	8	19	-	-	68	0,5	6
PLSC6X08050T10	PLSW6X08050T10	8,0	8	19	-	-	68	1,0	6
PLSC6X10050T05	PLSW6X10050T05	10,0	10	22	-	-	80	0,5	6
PLSC6X10050T10	PLSW6X10050T10	10,0	10	22	-	-	80	1,0	6
PLSC6X10050T15	PLSW6X10050T15	10,0	10	22	-	-	80	1,5	6
PLSC6X10050T20	PLSW6X10050T20	10,0	10	22	-	-	80	2,0	6
PLSC6X12050T05	PLSW6X12050T05	12,0	12	26	-	-	93	0,5	6
PLSC6X12050T10	PLSW6X12050T10	12,0	12	26	-	-	93	1,0	6
PLSC6X12050T15	PLSW6X12050T15	12,0	12	26	-	-	93	1,5	6
PLSC6X12050T20	PLSW6X12050T20	12,0	12	26	-	-	93	2,0	6
PLSC6X16050T05	PLSW6X16050T05	16,0	16	32	-	-	108	0,5	6
PLSC6X16050T10	PLSW6X16050T10	16,0	16	32	-	-	108	1,0	6
PLSC6X16050T15	PLSW6X16050T15	16,0	16	32	-	-	108	1,5	6
PLSC6X16050T20	PLSW6X16050T20	16,0	16	32	-	-	108	2,0	6
PLSC8X20050T05	PLSW8X20050T05	20,0	20	38	-	-	126	0,5	8
PLSC8X20050T10	PLSW8X20050T10	20,0	20	38	-	-	126	1,0	8
PLSC8X20050T15	PLSW8X20050T15	20,0	20	38	-	-	126	1,5	8
PLSC8X20050T20	PLSW8X20050T20	20,0	20	38	-	-	126	2,0	8



2 flute ball nose; 30° helix; SCT norm; long reach; AlCrN coated
 Radiusfräser 2 Schneiden; 30° Drallwinkel; SCT Norm; abgesetzter Schaft; AlCrN beschichtet

Specifications / Spezifikationen



DIN 6535 HA	DIN 6535 HB	Dc	Ds	Lc	Ln	Dn	Lt	r	z
PLSC2X02030B	PLSW2X02030B	2,0	6	3	7	1,9	62	1,0	2
PLSC2X03030B	PLSW2X03030B	3,0	6	4	9,5	2,8	62	1,5	2
PLSC2X04030B	PLSW2X04030B	4,0	6	5	12	4,8	62	2,0	2
PLSC2X05030B	PLSW2X05030B	5,0	6	6	14,5	4,8	80	2,5	2
PLSC2X06030B	PLSW2X06030B	6,0	6	7	17	5,7	80	3,0	2
PLSC2X08030B	PLSW2X08030B	8,0	8	9	22	7,6	90	4,0	2
PLSC2X10030B	PLSW2X10030B	10,0	10	11	27	9,5	100	5,0	2
PLSC2X12030B	PLSW2X12030B	12,0	12	13	32	11,5	120	6,0	2
PLSC2X14030B	PLSW2X14030B	14,0	14	15	37	13,5	120	7,0	2
PLSC2X16030B	PLSW2X16030B	16,0	16	17	42	15,5	140	8,0	2
PLSC2X18030B	PLSW2X18030B	18,0	18	19	47	17,5	140	9,0	2
PLSC2X20030B	PLSW2X20030B	20,0	20	21	52	19,5	160	10,0	2



Other dimensions on request / Andere Abmessungen auf Anfrage

Dimensions in mm / Maße in mm

4 flute ball nose; 30° helix; SCT norm; long reach; AlCrN coated
 Radiusfräser 4 Schneiden; 30° Drallwinkel; SCT Norm; abgesetzter Schaft; AlCrN beschichtet

Specifications / Spezifikationen



DIN 6535 HA	DIN 6535 HB	Dc	Ds	Lc	Ln	Dn	Lt	r	z
PLSC4X02030B	PLSW4X02030B	2,0	6	3	7	1,9	62	1,0	4
PLSC4X03030B	PLSW4X03030B	3,0	6	4	9,5	2,8	62	1,5	4
PLSC4X04030B	PLSW4X04030B	4,0	6	5	12	3,8	62	2,0	4
PLSC4X05030B	PLSW4X05030B	5,0	6	6	14,5	4,8	80	2,5	4
PLSC4X06030B	PLSW4X06030B	6,0	6	7	17	5,7	80	3,0	4
PLSC4X08030B	PLSW4X08030B	8,0	8	9	22	7,6	90	4,0	4
PLSC4X10030B	PLSW4X10030B	10,0	10	11	27	9,5	100	5,0	4
PLSC4X12030B	PLSW4X12030B	12,0	12	13	32	11,5	120	6,0	4
PLSC4X14030B	PLSW4X14030B	14,0	14	15	37	13,5	120	7,0	4
PLSC4X16030B	PLSW4X16030B	16,0	16	17	42	15,5	140	8,0	4
PLSC4X18030B	PLSW4X18030B	18,0	18	19	47	17,5	140	9,0	4
PLSC4X20030B	PLSW4X20030B	20,0	20	21	52	19,5	160	10,0	4



3 flute end mill; 54°-55°-56° helix; SCT norm; long length; AlCrN-based coated

Schafffräser 3 Schneiden; 54°-55°-56° Drallwinkel; SCT Norm; lange Ausführung; AlCrN-basierte Schicht

Workpiece material groups and cutting speed / Werkstoffgruppen und Schnittgeschwindigkeiten

Material Material	Tensile strength Zugfestigkeit Rm [N/mm ²]	Hardness Härte [HB/HRC]	Cutting speed Vc [m/min] Schnittgeschwindigkeiten		
			min	opt	max
P1 Plain carbon steel / Unlegierter Stahl	< 600	< 230	-	-	-
P2 Alloy Steel / Legierter Stahl	< 1200	< 350	-	-	-
P3 High alloy steel and tool steel / Hochlegierter Stahl und Werkzeugstahl	< 1400	< 380	-	-	-
M1 Aust. and Ferr. Stainless steel / Aust. und Ferr. rostfreie Stähle	< 680	< 220	90	120	150
M2 Mart. Stainless steel / Mart. rostfreie Stähle	< 820	< 240	70	100	130
K1 Grey cast iron / Grauguß	-	< 280	-	-	-
K2 Ductile cast iron / Sphäroguß	-	< 320	-	-	-
N1 Non-ferrous alloys / Nichteisenmetalle	< 250	< 110	-	-	-
N2 Aluminium alloys / Aluminiumlegierungen	< 530	< 130	-	-	-
S1 High temperature alloys Fe, Ni and Co based / Warmfeste Leg. Fe, Ni und Co	< 3300	< 350	60	70	80
S2 Titanium alloys; Alpha and Beta / Titan Legierungen Alpha und Beta	< 2100	< 400	80	90	100
H1 Hardened steel / Gehärtete Stähle	-	< 54 HRC	-	-	-
H2 Hardened steel / Gehärtete Stähle	-	52-60 HRC	-	-	-
H3 Hardened steel / Gehärtete Stähle	-	> 58 HRC	-	-	-
G1 Graphite / Graphit	-	-	-	-	-

Cutting conditions / Zerspanungswerte

Peripheral milling / Umfangfräsen



Dc	Ap [2.3xD]	Ae 1 [0.2xD]	Ae 2 [0.4xD]	fz 1 ▼▼	fz 2 ▼
3,0	6,9	0,6	1,2	0,025	0,035
4,0	9,2	0,8	1,6	0,033	0,047
5,0	11,5	1,0	2,0	0,042	0,058
6,0	13,8	1,2	2,4	0,050	0,070
8,0	18,4	1,6	3,2	0,067	0,093
10,0	23,0	2,0	4,0	0,083	0,117
12,0	27,6	2,4	4,8	0,100	0,140
14,0	32,2	2,8	5,6	0,117	0,163
16,0	36,8	3,2	6,4	0,133	0,187
18,0	41,4	3,6	7,2	0,150	0,210
20,0	46,0	4,0	8,0	0,167	0,233

Slot milling / Vollnutfräsen



Dc	Ap [0.25xD]	Ae [1xD]	fz
3,0	0,8	3,0	0,015
4,0	1,0	4,0	0,020
5,0	1,3	5,0	0,025
6,0	1,5	6,0	0,030
8,0	2,0	8,0	0,040
10,0	2,5	10,0	0,050
12,0	3,0	12,0	0,060
14,0	3,5	14,0	0,070
16,0	4,0	16,0	0,080
18,0	4,5	18,0	0,090
20,0	5,0	20,0	0,100

3 flute end mill; 54°-55°-56° helix; SCT norm; long length; AlCrN-based coated
 Schafffräser 3 Schneiden; 54°-55°-56° Drallwinkel; SCT Norm; lange Ausführung; AlCrN-basierte Schicht

Specifications / Spezifikationen

DIN 6535 HA	DIN 6535 HB	Dc	Ds	Lc	Ln	Dn	Lt	r	z
PLIC3L03055V	PLIW3L03055V	3,0	6	8	14	2,8	57	-	3
PLIC3L04055V	PLIW3L04055V	4,0	6	11	16	3,8	57	-	3
PLIC3L05055V	PLIW3L05055V	5,0	6	13	18	4,8	57	-	3
PLIC3L06055V	PLIW3L06055V	6,0	6	13	19	5,7	57	-	3
PLIC3L08055V	PLIW3L08055V	8,0	8	19	25	7,6	63	-	3
PLIC3L10055V	PLIW3L10055V	10,0	10	22	30	9,5	72	-	3
PLIC3L12055V	PLIW3L12055V	12,0	12	26	36	11,5	83	-	3
PLIC3L14055V	PLIW3L14055V	14,0	14	26	36	13,5	83	-	3
PLIC3L16055V	PLIW3L16055V	16,0	16	32	42	15,5	92	-	3
PLIC3L18055V	PLIW3L18055V	18,0	18	32	42	17,5	92	-	3
PLIC3L20055V	PLIW3L20055V	20,0	20	38	52	19,5	104	-	3



4 flute end mill; 55° helix; SCT norm; long length; AlCrN-based coated

Schaftfräser 4 Schneiden; 55° Drallwinkel; SCT Norm; lange Ausführung; AlCrN-basierte Schicht

Workpiece material groups and cutting speed / Werkstoffgruppen und Schnittgeschwindigkeiten

Material Material	Tensile strength Zugfestigkeit Rm [N/mm ²]	Hardness Härte [HB/HRC]	Cutting speed Vc [m/min] Schnittgeschwindigkeiten		
			min	opt	max
P1 Plain carbon steel / Unlegierter Stahl	< 600	< 230	-	-	-
P2 Alloy Steel / Legierter Stahl	< 1200	< 350	-	-	-
P3 High alloy steel and tool steel / Hochlegierter Stahl und Werkzeugstahl	< 1400	< 380	-	-	-
M1 Aust. and Ferr. Stainless steel / Aust. und Ferr. rostfreie Stähle	< 680	< 220	90	120	150
M2 Mart. Stainless steel / Mart. rostfreie Stähle	< 820	< 240	70	100	130
K1 Grey cast iron / Grauguß	-	< 280	-	-	-
K2 Ductile cast iron / Sphäroguß	-	< 320	-	-	-
N1 Non-ferrous alloys / Nichteisenmetalle	< 250	< 110	-	-	-
N2 Aluminium alloys / Aluminiumlegierungen	< 530	< 130	-	-	-
S1 High temperature alloys Fe, Ni and Co based / Warmfeste Leg. Fe, Ni und Co	< 3300	< 350	60	70	80
S2 Titanium alloys; Alpha and Beta / Titan Legierungen Alpha und Beta	< 2100	< 400	80	90	100
H1 Hardened steel / Gehärtete Stähle	-	< 54 HRC	-	-	-
H2 Hardened steel / Gehärtete Stähle	-	52-60 HRC	-	-	-
H3 Hardened steel / Gehärtete Stähle	-	> 58 HRC	-	-	-
G1 Graphite / Graphit	-	-	-	-	-

Cutting conditions / Zerspanungswerte

Peripheral milling / Umfangfräsen



Dc	Ap	Ae 1	Ae 2	fz 1	fz 2
	[1.75xD]	[0.2xD]	[0.4xD]	▼▼	▼
6,0	10,5	1,2	2,4	0,017	0,03
8,0	14,0	1,6	3,2	0,023	0,04
10,0	17,5	2,0	4,0	0,028	0,05
12,0	21,0	2,4	4,8	0,034	0,06
14,0	24,5	2,8	5,6	0,040	0,07
16,0	28,0	3,2	6,4	0,045	0,08
18,0	31,5	3,6	7,2	0,051	0,09
20,0	35,0	4,0	8,0	0,057	0,10

Slot milling / Vollnutfräsen



Dc	Ap	Ae	fz
	[1xD]	[1xD]	
6,0	6,0	6,0	0,020
8,0	8,0	8,0	0,027
10,0	10,0	10,0	0,033
12,0	12,0	12,0	0,040
14,0	14,0	14,0	0,047
16,0	16,0	16,0	0,053
18,0	18,0	18,0	0,060
20,0	20,0	20,0	0,067

4 flute end mill; 55° helix; SCT norm; long length; AlCrN-based coated
 Schafffräser 4 Schneiden; 55° Drallwinkel; SCT Norm; lange Ausführung; AlCrN-basierte Schicht

Specifications / Spezifikationen



DIN 6535 HA	DIN 6535 HB	Dc	Ds	Lc	Ln	Dn	Lt	r	z
PLIC4L06055S	PLIW4L06055S	6,0	6	13	19	5,7	57	-	4
PLIC4L08055S	PLIW4L08055S	8,0	8	19	25	7,6	63	-	4
PLIC4L10055S	PLIW4L10055S	10,0	10	22	30	9,5	72	-	4
PLIC4L12055S	PLIW4L12055S	12,0	12	26	36	11,5	83	-	4
PLIC4L14055S	PLIW4L14055S	14,0	14	26	36	13,5	83	-	4
PLIC4L16055S	PLIW4L16055S	16,0	16	32	42	15,5	92	-	4
PLIC4L18055S	PLIW4L18055S	18,0	18	32	42	17,5	92	-	4
PLIC4L20055S	PLIW4L20055S	20,0	20	38	52	19,5	104	-	4



4 flute end mill; 55° helix; SCT norm; long reach; AlCrN-based coated

Schafffräser 4 Schneiden; 55° Drallwinkel; SCT Norm; abgesetzter Schaft; AlCrN-basierte Schicht

Workpiece material groups and cutting speed / Werkstoffgruppen und Schnittgeschwindigkeiten

Material Material	Tensile strength Zugfestigkeit Rm [N/mm ²]	Hardness Härte [HB/HRC]	Cutting speed Vc [m/min] Schnittgeschwindigkeiten		
			min	opt	max
P1 Plain carbon steel / Unlegierter Stahl	< 600	< 230	-	-	-
P2 Alloy Steel / Legierter Stahl	< 1200	< 350	-	-	-
P3 High alloy steel and tool steel / Hochlegierter Stahl und Werkzeugstahl	< 1400	< 380	-	-	-
M1 Aust. and Ferr. Stainless steel / Aust. und Ferr. rostfreie Stähle	< 680	< 220	90	120	150
M2 Mart. Stainless steel / Mart. rostfreie Stähle	< 820	< 240	70	100	130
K1 Grey cast iron / Grauguß	-	< 280	-	-	-
K2 Ductile cast iron / Sphäroguß	-	< 320	-	-	-
N1 Non-ferrous alloys / Nichteisenmetalle	< 250	< 110	-	-	-
N2 Aluminium alloys / Aluminiumlegierungen	< 530	< 130	-	-	-
S1 High temperature alloys Fe, Ni and Co based / Warmfeste Leg. Fe, Ni und Co	< 3300	< 350	60	70	80
S2 Titanium alloys; Alpha and Beta / Titan Legierungen Alpha und Beta	< 2100	< 400	80	90	100
H1 Hardened steel / Gehärtete Stähle	-	< 54 HRC	-	-	-
H2 Hardened steel / Gehärtete Stähle	-	52-60 HRC	-	-	-
H3 Hardened steel / Gehärtete Stähle	-	> 58 HRC	-	-	-
G1 Graphite / Graphit	-	-	-	-	-

Cutting conditions / Zerspanungswerte

Peripheral milling / Umfangfräsen



Dc	Ap [0.5xD]	Ae 1 [0.2xD]	Ae 2 [0.4xD]	fz 1 ▼▼	fz 2 ▼
6,0	3,0	1,2	2,4	0,017	0,03
8,0	4,0	1,6	3,2	0,023	0,04
10,0	5,0	2,0	4,0	0,028	0,05
12,0	6,0	2,4	4,8	0,034	0,06
14,0	7,0	2,8	5,6	0,040	0,07
16,0	8,0	3,2	6,4	0,045	0,08
18,0	9,0	3,6	7,2	0,051	0,09
20,0	10,0	4,0	8,0	0,057	0,10

Slot milling / Vollnutfräsen



Dc	Ap [0.5xD]	Ae [1xD]	fz
6,0	3,0	6,0	0,020
8,0	4,0	8,0	0,027
10,0	5,0	10,0	0,033
12,0	6,0	12,0	0,040
14,0	7,0	14,0	0,047
16,0	8,0	16,0	0,053
18,0	9,0	18,0	0,060
20,0	10,0	20,0	0,067

4 flute end mill; 55° helix; SCT norm; long reach; AlCrN-based coated
 Schafffräser 4 Schneiden; 55° Drallwinkel; SCT Norm; abgesetzter Schaft; AlCrN-basierte Schicht

Specifications / Spezifikationen



DIN 6535 HA	DIN 6535 HB	Dc	Ds	Lc	Ln	Dn	Lt	r	z
PLIC4X06055S	PLIW4X06055S	6,0	6	7	24	5,4	62	-	4
PLIC4X08055S	PLIW4X08055S	8,0	8	9	30	7,2	68	-	4
PLIC4X10055S	PLIW4X10055S	10,0	10	11	38	9,0	80	-	4
PLIC4X12055S	PLIW4X12055S	12,0	12	13	46	11,0	93	-	4
PLIC4X14055S	PLIW4X14055S	14,0	14	15	46	13,0	93	-	4
PLIC4X16055S	PLIW4X16055S	16,0	16	17	58	15,0	108	-	4
PLIC4X18055S	PLIW4X18055S	18,0	18	19	59	17,0	108	-	4
PLIC4X20055S	PLIW4X20055S	20,0	20	21	74	19,0	126	-	4



Other dimensions on request / Andere Abmessungen auf Anfrage

Dimensions in mm / Maße in mm

3 flute rougher; 35°-36°-36° helix; SCT norm; long length; AlCrN-based coated

Schafffräser 3 Schneiden; 35°-36°-36° Drallwinkel; SCT Norm; lange Ausführung; AlCrN-basierte Schicht

Workpiece material groups and cutting speed / Werkstoffgruppen und Schnittgeschwindigkeiten

Material Material	Tensile strength Zugfestigkeit Rm [N/mm ²]	Hardness Härte [HB/HRC]	Cutting speed Vc [m/min] Schnittgeschwindigkeiten		
			min	opt	max
P1 Plain carbon steel / Unlegierter Stahl	< 600	< 230	-	-	-
P2 Alloy Steel / Legierter Stahl	< 1200	< 350	-	-	-
P3 High alloy steel and tool steel / Hochlegierter Stahl und Werkzeugstahl	< 1400	< 380	-	-	-
M1 Aust. and Ferr. Stainless steel / Aust. und Ferr. rostfreie Stähle	< 680	< 220	90	120	150
M2 Mart. Stainless steel / Mart. rostfreie Stähle	< 820	< 240	70	100	130
K1 Grey cast iron / Grauguß	-	< 280	-	-	-
K2 Ductile cast iron / Sphäroguß	-	< 320	-	-	-
N1 Non-ferrous alloys / Nichteisenmetalle	< 250	< 110	-	-	-
N2 Aluminium alloys / Aluminiumlegierungen	< 530	< 130	-	-	-
S1 High temperature alloys Fe, Ni and Co based / Warmfeste Leg. Fe, Ni und Co	< 3300	< 350	60	70	80
S2 Titanium alloys; Alpha and Beta / Titan Legierungen Alpha und Beta	< 2100	< 400	80	90	100
H1 Hardened steel / Gehärtete Stähle	-	< 54 HRC	-	-	-
H2 Hardened steel / Gehärtete Stähle	-	52-60 HRC	-	-	-
H3 Hardened steel / Gehärtete Stähle	-	> 58 HRC	-	-	-
G1 Graphite / Graphit	-	-	-	-	-

Cutting conditions / Zerspanungswerte

Peripheral milling / Umfangfräsen



Dc	Ap	Ae 1	Ae 2	fz 1	fz 2
	[1.75xD]	[0.4xD]	[0.6xD]	▼▼	▼
6,0	10,5	2,4	3,6	0,015	0,035
8,0	14,0	3,2	4,8	0,02	0,047
10,0	17,5	4,0	6,0	0,025	0,058
12,0	21,0	4,8	7,2	0,03	0,07
16,0	28,0	6,4	9,6	0,04	0,093
20,0	35,0	8,0	12,0	0,05	0,117

Slot milling / Vollnutfräsen



Dc	Ap	Ae	fz
	[1xD]	[1xD]	
6,0	6,0	6,0	0,020
8,0	8,0	8,0	0,027
10,0	10,0	10,0	0,033
12,0	12,0	12,0	0,040
16,0	16,0	16,0	0,053
20,0	20,0	20,0	0,067

3 flute rougher; 35°-36°-36° helix; SCT norm; long length; AlCrN-based coated
 Schaftfräser 3 Schneiden; 35°-36°-36° Drallwinkel; SCT Norm; lange Ausführung; AlCrN-basierte Schicht

Specifications / Spezifikationen



DIN 6535 HA	DIN 6535 HB	Dc	Ds	Lc	Ln	Dn	Lt	r	z
PLIC3L06035R	PLIW3L06035R	6,0	6	13	19	5,7	57	-	3
PLIC3L08035R	PLIW3L08035R	8,0	8	19	25	7,6	63	-	3
PLIC3L10305R	PLIW3L10035R	10,0	10	22	30	9,5	72	-	3
PLIC3L12035R	PLIW3L12035R	12,0	12	26	36	11,5	83	-	3
PLIC3L16035R	PLIW3L16035R	16,0	16	32	42	15,5	92	-	3
PLIC3L20035R	PLIW3L20035R	20,0	20	38	52	19,5	104	-	3



3 flute end mill; 44°-45°-46° helix; SCT norm; long length; CrN coated

Schaftfräser 3 Schneiden; 44°-45°-46° Drallwinkel; SCT Norm; lange Ausführung; CrN beschichtet

Workpiece material groups and cutting speed / Werkstoffgruppen und Schnittgeschwindigkeiten

Material Material	Tensile strength Zugfestigkeit Rm [N/mm ²]	Hardness Härte [HB/HRC]	Cutting speed Vc [m/min] Schnittgeschwindigkeiten		
			min	opt	max
P1 Plain carbon steel / Unlegierter Stahl	< 600	< 230	-	-	-
P2 Alloy Steel / Legierter Stahl	< 1200	< 350	-	-	-
P3 High alloy steel and tool steel / Hochlegierter Stahl und Werkzeugstahl	< 1400	< 380	-	-	-
M1 Aust. and Ferr. Stainless steel / Aust. und Ferr. rostfreie Stähle	< 680	< 220	-	-	-
M2 Mart. Stainless steel / Mart. rostfreie Stähle	< 820	< 240	-	-	-
K1 Grey cast iron / Grauguß	-	< 280	-	-	-
K2 Ductile cast iron / Sphäroguß	-	< 320	-	-	-
N1 Non-ferrous alloys / Nichteisenmetalle	< 250	< 110	300	500	700
N2 Aluminium alloys / Aluminiumlegierungen	< 530	< 130	150	200	250
S1 High temperature alloys Fe, Ni and Co based / Warmfeste Leg. Fe, Ni und Co	< 3300	< 350	-	-	-
S2 Titanium alloys; Alpha and Beta / Titan Legierungen Alpha und Beta	< 2100	< 400	-	-	-
H1 Hardened steel / Gehärtete Stähle	-	< 54 HRC	-	-	-
H2 Hardened steel / Gehärtete Stähle	-	52-60 HRC	-	-	-
H3 Hardened steel / Gehärtete Stähle	-	> 58 HRC	-	-	-
G1 Graphite / Graphit	-	-	-	-	-

Cutting conditions / Zerspanungswerte

Peripheral milling / Umfangfräsen



Dc	Ap [2xD]	Ae 1 [0.4xD]	Ae 2 [0.6xD]	fz 1 ▼▼	fz 2 ▼
6,0	12,0	2,4	3,6	0,036	0,054
8,0	16,0	3,2	4,8	0,048	0,072
10,0	20,0	4,0	6,0	0,060	0,090
12,0	24,0	4,8	7,2	0,072	0,108
14,0	28,0	5,6	8,4	0,084	0,126
16,0	32,0	6,4	9,6	0,096	0,144
18,0	36,0	7,2	10,8	0,108	0,162
20,0	40,0	8,0	12,0	0,120	0,180
25,0	50,0	10,0	15,0	0,150	0,225

Slot milling / Vollnutfräsen



Dc	Ap [1.5xD]	Ae [1xD]	fz
6,0	9,0	6,0	0,021
8,0	12,0	8,0	0,028
10,0	15,0	10,0	0,035
12,0	18,0	12,0	0,042
14,0	21,0	14,0	0,049
16,0	24,0	16,0	0,056
18,0	27,0	18,0	0,063
20,0	30,0	20,0	0,070
25,0	37,5	25,0	0,088

3 flute end mill; 44°-45°-46° helix; SCT norm; long length; CrN coated
 Schaftfräser 3 Schneiden; 44°-45°-46° Drallwinkel; SCT Norm; lange Ausführung; CrN beschichtet

Specifications / Spezifikationen



DIN 6535 HA	DIN 6535 HB	Dc	Ds	Lc	Ln	Dn	Lt	r	z
PLAC3L06045V	PLAW3L06045V	6,0	6	15	-	-	57	0,2	3
PLAC3L08045V	PLAW3L08045V	8,0	8	21	-	-	63	0,2	3
PLAC3L10045V	PLAW3L10045V	10,0	10	24	-	-	72	0,3	3
PLAC3L12045V	PLAW3L12045V	12,0	12	28	-	-	83	0,4	3
PLAC3L14045V	PLAW3L14045V	14,0	14	30	-	-	83	0,4	3
PLAC3L16045V	PLAW3L16045V	16,0	16	35	-	-	92	0,5	3
PLAC3L18045V	PLAW3L18045V	18,0	18	38	-	-	92	0,5	3
PLAC3L20045V	PLAW3L20045V	20,0	20	42	-	-	104	0,6	3
PLAC3L25045V	PLAW3L25045V	25,0	25	50	-	-	120	0,6	3



3 flute end mill; 44°-45°-46° helix; SCT norm; long reach; CrN coated

Schaftfräser 3 Schneiden; 44°-45°-46° Drallwinkel; SCT Norm; abgesetzter Schaft; CrN beschichtet

Workpiece material groups and cutting speed / Werkstoffgruppen und Schnittgeschwindigkeiten

Material Material	Tensile strength Zugfestigkeit Rm [N/mm ²]	Hardness Härte [HB/HRC]	Cutting speed Vc [m/min] Schnittgeschwindigkeiten		
			min	opt	max
P1 Plain carbon steel / Unlegierter Stahl	< 600	< 230	-	-	-
P2 Alloy Steel / Legierter Stahl	< 1200	< 350	-	-	-
P3 High alloy steel and tool steel / Hochlegierter Stahl und Werkzeugstahl	< 1400	< 380	-	-	-
M1 Aust. and Ferr. Stainless steel / Aust. und Ferr. rostfreie Stähle	< 680	< 220	-	-	-
M2 Mart. Stainless steel / Mart. rostfreie Stähle	< 820	< 240	-	-	-
K1 Grey cast iron / Grauguß	-	< 280	-	-	-
K2 Ductile cast iron / Sphäroguß	-	< 320	-	-	-
N1 Non-ferrous alloys / Nichteisenmetalle	< 250	< 110	300	500	700
N2 Aluminium alloys / Aluminiumlegierungen	< 530	< 130	150	200	250
S1 High temperature alloys Fe, Ni and Co based / Warmfeste Leg. Fe, Ni und Co	< 3300	< 350	-	-	-
S2 Titanium alloys; Alpha and Beta / Titan Legierungen Alpha und Beta	< 2100	< 400	-	-	-
H1 Hardened steel / Gehärtete Stähle	-	< 54 HRC	-	-	-
H2 Hardened steel / Gehärtete Stähle	-	52-60 HRC	-	-	-
H3 Hardened steel / Gehärtete Stähle	-	> 58 HRC	-	-	-
G1 Graphite / Graphit	-	-	-	-	-

Cutting conditions / Zerspanungswerte

Peripheral milling / Umfangfräsen



Dc	Ap [0.5xD]	Ae 1 [0.2xD]	Ae 2 [0.3xD]	fz 1 ▼▼	fz 2 ▼
6,0	3,0	1,2	1,8	0,036	0,06
8,0	4,0	1,6	2,4	0,048	0,08
10,0	5,0	2,0	3,0	0,060	0,10
12,0	6,0	2,4	3,6	0,072	0,12
14,0	7,0	2,8	4,2	0,084	0,14
16,0	8,0	3,2	4,8	0,096	0,16
18,0	9,0	3,6	5,4	0,108	0,18
20,0	10,0	4,0	6,0	0,120	0,20
25,0	12,5	5,0	7,5	0,150	0,25

Slot milling / Vollnutfräsen



Dc	Ap [0.25xD]	Ae [1xD]	fz
6,0	1,5	6,0	0,024
8,0	2,0	8,0	0,032
10,0	2,5	10,0	0,040
12,0	3,0	12,0	0,048
14,0	3,5	14,0	0,056
16,0	4,0	16,0	0,064
18,0	4,5	18,0	0,072
20,0	5,0	20,0	0,080
25,0	6,3	25,0	0,100

3 flute end mill; 44°-45°-46° helix; SCT norm; long reach; CrN coated
 Schaftfräser 3 Schneiden; 44°-45°-46° Drallwinkel; SCT Norm; abgesetzter Schaft; CrN beschichtet

Specifications / Spezifikationen

DIN 6535 HA	DIN 6535 HB	Dc	Ds	Lc	Ln	Dn	Lt	r	z
PLAC3X06045V	PLAW3X06045V	6,0	6	7	24	5,0	62	0,2	3
PLAC3X08045V	PLAW3X08045V	8,0	8	9	30	7,0	68	0,2	3
PLAC3X10045V	PLAW3X10045V	10,0	10	11	38	9,0	80	0,3	3
PLAC3X12045V	PLAW3X12045V	12,0	12	13	46	11,0	93	0,4	3
PLAC3X14045V	PLAW3X14045V	14,0	14	15	46	13,0	93	0,4	3
PLAC3X16045V	PLAW3X16045V	16,0	16	17	58	15,0	108	0,5	3
PLAC3X18045V	PLAW3X18045V	18,0	18	19	58	17,0	108	0,5	3
PLAC3X20045V	PLAW3X20045V	20,0	20	21	74	19,0	126	0,6	3
PLAC3X25045V	PLAW3X25045V	25,0	25	26	92	24,0	150	0,6	3



3 flute rougher; 35°-36°-36° helix; SCT norm; long length; CrN coated

Schruppfräser 3 Schneiden; 35°-36°-36° Drallwinkel; SCT Norm; lange Ausführung; CrN beschichtet

Workpiece material groups and cutting speed / Werkstoffgruppen und Schnittgeschwindigkeiten

Material Material	Tensile strength Zugfestigkeit Rm [N/mm ²]	Hardness Härte [HB/HRC]	Cutting speed Vc [m/min] Schnittgeschwindigkeiten		
			min	opt	max
P1 Plain carbon steel / Unlegierter Stahl	< 600	< 230	-	-	-
P2 Alloy Steel / Legierter Stahl	< 1200	< 350	-	-	-
P3 High alloy steel and tool steel / Hochlegierter Stahl und Werkzeugstahl	< 1400	< 380	-	-	-
M1 Aust. and Ferr. Stainless steel / Aust. und Ferr. rostfreie Stähle	< 680	< 220	-	-	-
M2 Mart. Stainless steel / Mart. rostfreie Stähle	< 820	< 240	-	-	-
K1 Grey cast iron / Grauguß	-	< 280	-	-	-
K2 Ductile cast iron / Sphäroguß	-	< 320	-	-	-
N1 Non-ferrous alloys / Nichteisenmetalle	< 250	< 110	300	500	700
N2 Aluminium alloys / Aluminiumlegierungen	< 530	< 130	150	200	250
S1 High temperature alloys Fe, Ni and Co based / Warmfeste Leg. Fe, Ni und Co	< 3300	< 350	-	-	-
S2 Titanium alloys; Alpha and Beta / Titan Legierungen Alpha und Beta	< 2100	< 400	-	-	-
H1 Hardened steel / Gehärtete Stähle	-	< 54 HRC	-	-	-
H2 Hardened steel / Gehärtete Stähle	-	52-60 HRC	-	-	-
H3 Hardened steel / Gehärtete Stähle	-	> 58 HRC	-	-	-
G1 Graphite / Graphit	-	-	-	-	-

Cutting conditions / Zerspanungswerte

Peripheral milling / Umfangfräsen



Dc	Ap [2xD]	Ae 1 [0.2xD]	Ae 2 [0.4xD]	fz 1 ▼▼	fz 2 ▼
6,0	12,0	1,2	2,4	0,036	0,06
8,0	16,0	1,6	3,2	0,048	0,08
10,0	20,0	2,0	4,0	0,060	0,10
12,0	24,0	2,4	4,8	0,072	0,12
14,0	28,0	2,8	5,6	0,084	0,14
16,0	32,0	3,2	6,4	0,096	0,16
18,0	36,0	3,6	7,2	0,108	0,18
20,0	40,0	4,0	8,0	0,120	0,20
25,0	50,0	5,0	10,0	0,150	0,25

Slot milling / Vollnutfräsen



Dc	Ap [1.5xD]	Ae [1xD]	fz
6,0	9,0	6,0	0,024
8,0	12,0	8,0	0,032
10,0	15,0	10,0	0,040
12,0	18,0	12,0	0,048
14,0	21,0	14,0	0,056
16,0	24,0	16,0	0,064
18,0	27,0	18,0	0,072
20,0	30,0	20,0	0,080
25,0	37,5	25,0	0,100

3 flute rougher; 35°-36°-36° helix; SCT norm; long length; CrN coated
 Schruppfräser 3 Schneiden; 35°-36°-36° Drallwinkel; SCT Norm; lange Ausführung; CrN beschichtet

Specifications / Spezifikationen



DIN 6535 HA	DIN 6535 HB	Dc	Ds	Lc	Ln	Dn	Lt	r	z
PLAC3L06035R	PLAW3L06035R	6,0	6	13	-	-	57	-	3
PLAC3L08035R	PLAW3L08035R	8,0	8	19	-	-	63	-	3
PLAC3L10035R	PLAW3L10035R	10,0	10	23	-	-	72	-	3
PLAC3L12035R	PLAW3L12035R	12,0	12	28	-	-	83	-	3
PLAC3L14035R	PLAW3L14035R	14,0	14	28	-	-	83	-	3
PLAC3L16035R	PLAW3L16035R	16,0	16	34	-	-	92	-	3
PLAC3L18035R	PLAW3L18035R	18,0	18	34	-	-	92	-	3
PLAC3L20035R	PLAW3L20035R	20,0	20	42	-	-	104	-	3
PLAC3L25035R	PLAW3L25035R	25,0	25	52	-	-	120	-	3



Multi flute fine pitch rougher; 25° helix; SCT norm; long length; CrN coated

Schrappfräser Feinkordel multi Schneiden; 25° Drallwinkel; SCT Norm; lange Ausführung; CrN beschichtet

Workpiece material groups and cutting speed / Werkstoffgruppen und Schnittgeschwindigkeiten

Material Material	Tensile strength Zugfestigkeit Rm [N/mm ²]	Hardness Härte [HB/HRC]	Cutting speed Vc [m/min] Schnittgeschwindigkeiten		
			min	opt	max
P1 Plain carbon steel / Unlegierter Stahl	< 600	< 230	-	-	-
P2 Alloy Steel / Legierter Stahl	< 1200	< 350	-	-	-
P3 High alloy steel and tool steel / Hochlegierter Stahl und Werkzeugstahl	< 1400	< 380	-	-	-
M1 Aust. and Ferr. Stainless steel / Aust. und Ferr. rostfreie Stähle	< 680	< 220	-	-	-
M2 Mart. Stainless steel / Mart. rostfreie Stähle	< 820	< 240	-	-	-
K1 Grey cast iron / Grauguß	-	< 280	-	-	-
K2 Ductile cast iron / Sphäroguß	-	< 320	-	-	-
N1 Non-ferrous alloys / Nichteisenmetalle	< 250	< 110	300	500	700
N2 Aluminium alloys / Aluminiumlegierungen	< 530	< 130	150	200	250
S1 High temperature alloys Fe, Ni and Co based / Warmfeste Leg. Fe, Ni und Co	< 3300	< 350	-	-	-
S2 Titanium alloys; Alpha and Beta / Titan Legierungen Alpha und Beta	< 2100	< 400	-	-	-
H1 Hardened steel / Gehärtete Stähle	-	< 54 HRC	-	-	-
H2 Hardened steel / Gehärtete Stähle	-	52-60 HRC	-	-	-
H3 Hardened steel / Gehärtete Stähle	-	> 58 HRC	-	-	-
G1 Graphite / Graphit	-	-	-	-	-

Cutting conditions / Zerspanungswerte

Peripheral milling / Umfangfräsen



Dc	Ap	Ae 1	Ae 2	fz 1	fz 2
	[1.5xD]	[0.25xD]	[0.5xD]	▼▼	▼
4,0	6,0	1,0	2,0	0,020	0,04
5,0	7,5	1,3	2,5	0,025	0,05
6,0	9,0	1,5	3,0	0,030	0,06
8,0	12,0	2,0	4,0	0,040	0,08
10,0	15,0	2,5	5,0	0,050	0,10
12,0	18,0	3,0	6,0	0,060	0,12
16,0	24,0	4,0	8,0	0,080	0,16
20,0	30,0	5,0	10,0	0,100	0,20

Slot milling / Vollnutfräsen



Dc	Ap	Ae	fz
	[1xD]	[1xD]	
4,0	4,0	4,0	0,016
5,0	5,0	5,0	0,020
6,0	6,0	6,0	0,024
8,0	8,0	8,0	0,032
10,0	10,0	10,0	0,040
12,0	12,0	12,0	0,048
16,0	16,0	16,0	0,064
20,0	20,0	20,0	0,080

Multi flute fine pitch rougher; 25° helix; SCT norm; long length; CrN coated
 Schruppfräser Feinkordel multi Schneiden; 25° Drallwinkel; SCT Norm; lange Ausführung; CrN beschichtet

Specifications / Spezifikationen



DIN 6535 HA	DIN 6535 HB	Dc	Ds	Lc	Ln	Dn	Lt	r	z
PLAC3L04025RF	PLAW3L04025RF	4,0	6	11	16	3,7	57	-	3
PLAC3L05025RF	PLAW3L05025RF	5,0	6	13	18	4,7	57	-	3
PLAC3L06025RF	PLAW3L06025RF	6,0	6	13	19	5,7	57	-	3
PLAC4L08025RF	PLAW4L08025RF	8,0	8	19	25	7,5	63	-	4
PLAC4L10025RF	PLAW4L10025RF	10,0	10	22	30	9,5	72	-	4
PLAC4L12025RF	PLAW4L12025RF	12,0	12	26	36	15,5	83	-	4
PLAC4L16025RF	PLAW4L16025RF	16,0	16	32	42	15,5	92	-	4
PLAC4L20025RF	PLAW4L20025RF	20,0	20	38	52	19,5	104	-	4



3 flute ball nose; 44°-45°-46° helix; SCT norm; long reach; CrN coated
 Radiusfräser 3 Schneiden; 44°-45°-46° Drallwinkel; SCT Norm; abgesetzter Schaft; CrN beschichtet

Specifications / Spezifikationen

DIN 6535 HA	DIN 6535 HB	Dc	Ds	Lc	Ln	Dn	Lt	r	z
PLAC3X06045B	PLAW3X06045B	6,0	6	9	24	5,4	62	3,0	3
PLAC3X08045B	PLAW3X08045B	8,0	8	12	30	7,2	68	4,0	3
PLAC3X10045B	PLAW3X10045B	10,0	10	15	38	9,0	80	5,0	3
PLAC3X12045B	PLAW3X12045B	12,0	12	18	46	11,0	93	6,0	3
PLAC3X14045B	PLAW3X14045B	14,0	14	21	46	13,0	93	7,0	3
PLAC3X16045B	PLAW3X16045B	16,0	16	24	58	15,0	108	8,0	3
PLAC3X18045B	PLAW3X18045B	18,0	18	27	58	17,0	108	9,0	3
PLAC3X20045B	PLAW3X20045B	20,0	20	30	74	19,0	126	10,0	3
PLAC3X25045B	PLAW3X25045B	25,0	25	38	92	24,0	150	12,5	3





PREMIUMLINE
SOLID CARBIDE END MILLS ®



Improving Quality Through Innovation

Product of Holland

UK D



ULTRA-X LINE

SOLID CARBIDE END MILLS ®

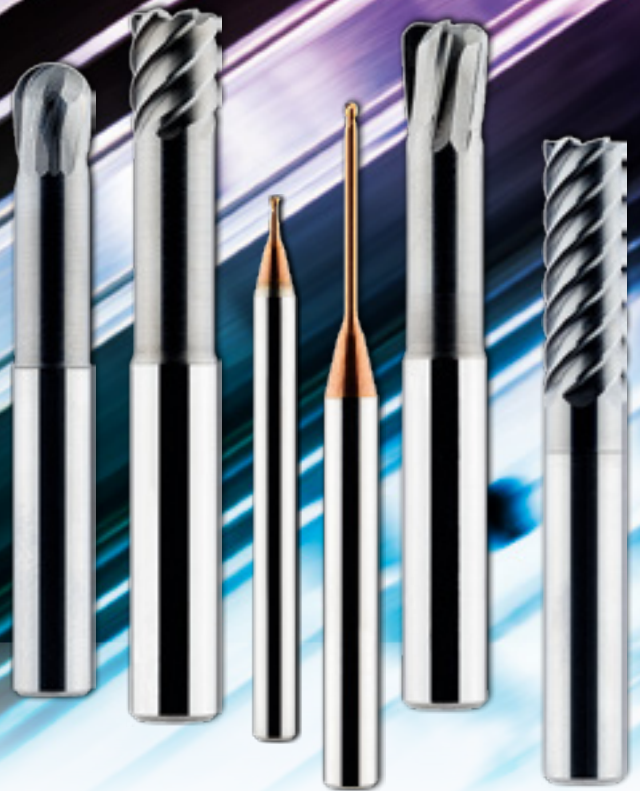

- ▶ Designed for mould & die / Entwickelt für Werkzeug- und Formenbau
- ▶ Hard machining / Hartbearbeitung
- ▶ High performance tools / Hochleistungswerkzeuge
- ▶ Specific carbide grades / Spezifische Hartmetallsorten
- ▶ Specific coatings / Spezifische Beschichtungen















Improving Quality Through Innovation

Product of Holland

Table of contents

Inhaltsverzeichnis

4 flute torical end mill; 30° helix; DIN6527S; short length; AlCrN-based Torusfräser 4 Schneiden; 30° Drallwinkel; DIN6527K; kurze Ausführung; AlCrN-basierte Schicht	4 - 5	
4 flute torical end mill; 30° helix; SCT norm; long reach; AlCrN-based Torusfräser 4 Schneiden; 30° Drallwinkel; SCT Norm; abgesetzter Schaft; AlCrN-basierte Schicht	6 - 7	
4 flute torical end mill; 10° helix; DIN6527S; long reach; AlCrN-based Torusfräser 4 Schneiden; 10° Drallwinkel; DIN6527K; abgesetzter Schaft; AlCrN-basierte Schicht	8 - 9	
4 flute torical end mill; 10° helix; SCT Norm; long reach; AlCrN-based Torusfräser 4 Schneiden; 10° Drallwinkel; SCT Norm; abgesetzter Schaft; AlCrN-basierte Schicht	10 - 11	
Multi flute torical end mill; 50° helix; DIN6527L; long reach; AlCrN-based Torusfräser multi Schneiden; 50° Drallwinkel; DIN6527L; abgesetzter Schaft, AlCrN-basierte Schicht	12 - 13	
Multi flute end mill; 50° helix; SCT norm; long length; AlCrN-based Torusfräser multi Schneiden; 50° Drallwinkel; SCT Norm; lange Ausführung, AlCrN-basierte Schicht	14 - 15	
Multi flute torical end mill; 50° helix; SCT norm; long reach; AlCrN-based Torusfräser multi Schneiden; 50° Drallwinkel; SCT Norm; abgesetzter Schaft, AlCrN-basierte Schicht	16 - 17	
2 flute ball nose end mill; 15° helix; DIN6527S; short length; AlCrN-based Radiusfräser 2 Schneiden; 15° Drallwinkel; DIN6527K; kurze Ausführung; AlCrN-basierte Schicht	18 - 19	
2 flute ball nose end mill; 15° helix; SCT norm; long reach; AlCrN-based Radiusfräser 2 Schneiden; 15° Drallwinkel; SCT Norm; abgesetzter Schaft; AlCrN-basierte Schicht	20 - 21	
2 flute torical end mill; 30° helix; SCT norm; short length; TiAINSi Torusfräser 2 Schneiden; 30° Drallwinkel; SCT Norm; kurze Ausführung; TiAINSi	NEW / NEU M I C R O 22 - 23	
2 flute torical end mill; 30° helix; SCT norm; long reach; TiAINSi Torusfräser 2 Schneiden; 30° Drallwinkel; SCT Norm; abgesetzter Schaft; TiAINSi	NEW / NEU M I C R O 24 - 25	
2 flute ballnose end mill; 30° helix; SCT norm; short length; TiAINSi Radiusfräser 2 Schneiden; 30° Drallwinkel; SCT Norm; kurze Ausführung; TiAINSi	NEW / NEU M I C R O 26 - 27	
2 flute ballnose end mill; 30° helix; SCT norm; long reach; TiAINSi Radiusfräser 2 Schneiden; 30° Drallwinkel; SCT Norm; abgesetzter Schaft; TiAINSi	NEW / NEU M I C R O 28 - 29	

4 flute torical end mill; 30° helix; DIN6527S; short length; AlCrN-based
 Torusfräser 4 Schneiden; 30° Drallwinkel; DIN6527K; kurzu Ausführung; AlCrN-basierte Schicht

Specifications / Spezifikationen



DIN 6535 HA	DIN 6535 HB	Dc	Ds	Lc	Ln	Dn	Lt	r	z
ULC4S03030SNT03	-	3,0	6	4	9	2,8	50	0.3	4
ULC4S04030SNT05	-	4,0	6	5	13	3,8	54	0.5	4
ULC4S05030SNT05	-	5,0	6	6	16	4,8	54	0.5	4
ULC4S06030SNT05	-	6,0	6	7	17	5,7	54	0.5	4
ULC4S06030SNT10	-	6,0	6	7	17	5,7	54	1.0	4
ULC4S08030SNT05	-	8,0	8	9	21	7,6	58	0.5	4
ULC4S08030SNT10	-	8,0	8	9	21	7,6	58	1.0	4
ULC4S10030SNT05	-	10,0	10	11	25	9,5	66	0.5	4
ULC4S10030SNT10	-	10,0	10	11	25	9,5	66	1.0	4
ULC4S12030SNT05	-	12,0	12	13	27	11,5	73	0.5	4
ULC4S12030SNT10	-	12,0	12	13	27	11,5	73	1.0	4



4 flute torical end mill; 30° helix; SCT norm; long reach; AlCrN-based
 Torusfräser 4 Schneiden; 30° Drallwinkel; SCT Norm; abgesetzter Schaft; AlCrN-basierte Schicht

Specifications / Spezifikationen



DIN 6535 HA	DIN 6535 HB	Dc	Ds	Lc	Ln	Dn	Lt	r	z
ULC4X03030SNT03	-	3,0	6	4	15	2,8	57	0.3	4
ULC4X04030SNT05	-	4,0	6	5	16	3,8	57	0.5	4
ULC4X05030SNT05	-	5,0	6	6	20	4,8	57	0.5	4
ULC4X06030SNT05	-	6,0	6	7	24	5,7	62	0.5	4
ULC4X06030SNT10	-	6,0	6	7	24	5,7	62	1.0	4
ULC4X08030SNT05	-	8,0	8	9	30	7,6	68	0.5	4
ULC4X08030SNT10	-	8,0	8	9	30	7,6	68	1.0	4
ULC4X10030SNT05	-	10,0	10	11	38	9,5	80	0.5	4
ULC4X10030SNT10	-	10,0	10	11	38	9,5	80	1.0	4
ULC4X12030SNT05	-	12,0	12	13	46	11,5	93	0.5	4
ULC4X12030SNT10	-	12,0	12	13	46	11,5	93	1.0	4



4 flute torical end mill; 10° helix; DIN6527S; long reach; AlCrN-based
 Torusfräser 4 Schneiden; 10° Drallwinkel; DIN6527K; abgesetzter Schaft; AlCrN-basierte Schicht

Specifications / Spezifikationen



DIN 6535 HA	DIN 6535 HB	Dc	Ds	Lc	Ln	Dn	Lt	r	z
ULC4S03010SNT075	-	3,0	6	4	9	2,7	50	0,75	4
ULC4S04010SNT100	-	4,0	6	5	13	3,6	54	1,00	4
ULC4S06010SNT150	-	6,0	6	7	17	5,4	54	1,50	4
ULC4S08010SNT200	-	8,0	8	9	22	7,2	58	2,00	4
ULC4S10010SNT200	-	10,0	10	11	26	9,0	66	2,00	4
ULC4S12010SNT300	-	12,0	12	13	28	11,0	73	3,00	4



Other dimensions on request / Andere Abmessungen auf Anfrage

Dimensions in mm / Maße in mm

4 flute torical end mill; 10° helix; SCT Norm; long reach; AlCrN-based

Torusfräser 4 Schneiden; 10° Drallwinkel; SCT Norm; abgesetzter Schaft; AlCrN-basierte Schicht

Workpiece material groups and cutting speed / Werkstoffgruppen und Schnittgeschwindigkeiten

Material Material	Tensile strength Zugfestigkeit Rm [N/mm ²]	Hardness Härte [HB/HRC]	Cutting speed Vc [m/min] Schnittgeschwindigkeiten		
			min	opt	max
P1 Plain carbon steel / Unlegierter Stahl	< 600	< 230	-	-	-
P2 Alloy Steel / Legierter Stahl	< 1200	< 350	-	-	-
P3 High alloy steel and tool steel / Hochlegierter Stahl und Werkzeugstahl	< 1400	< 380	-	-	-
M1 Aust. and Ferr. Stainless steel / Aust. und Ferr. rostfreie Stähle	< 680	< 220	-	-	-
M2 Mart. Stainless steel / Mart. rostfreie Stähle	< 820	< 240	-	-	-
K1 Grey cast iron / Grauguß	-	< 280	-	-	-
K2 Ductile cast iron / Sphäroguß	-	< 320	-	-	-
N1 Non-ferrous alloys / Nichteisenmetalle	< 250	< 110	-	-	-
N2 Aluminium alloys / Aluminiumlegierungen	< 530	< 130	-	-	-
S1 High temperature alloys Fe, Ni and Co based / Warmfeste Leg. Fe, Ni und Co	< 3300	< 350	-	-	-
S2 Titanium alloys; Alpha and Beta / Titan Legierungen Alpha und Beta	< 2100	< 400	-	-	-
H1 Hardened steel / Gehärtete Stähle	-	< 54 HRC	-	-	-
H2 Hardened steel / Gehärtete Stähle	-	52-60 HRC	60	120	180
H3 Hardened steel / Gehärtete Stähle	-	> 58 HRC	40	80	120
G1 Graphite / Graphit	-	-	-	-	-

Cutting conditions / Zerspanungswerte

High speed milling / Hochgeschwindigkeitsfräsen



Dc	Ap max [0.15xƒ]	Ae min [Dc-2ƒ]	fz 1 ▼▼
3	0,11	1,5	0,090
4	0,15	2,0	0,120
6	0,23	3,0	0,180
8	0,30	4,0	0,240
10	0,30	6,0	0,300
12	0,45	6,0	0,360

4 flute torical end mill; 10° helix; SCT Norm; long reach; AlCrN-based
 Torusfräser 4 Schneiden; 10° Drallwinkel; SCT Norm; abgesetzter Schaft; AlCrN-basierte Schicht

Specifications / Spezifikationen



DIN 6535 HA	DIN 6535 HB	Dc	Ds	Lc	Ln	Dn	Lt	r	z
ULC4X03010SNT075	-	3,0	6	4	11	2,7	57	0,75	4
ULC4X04010SNT100	-	4,0	6	5	16	3,6	57	1,00	4
ULC4X06010SNT150	-	6,0	6	7	24	5,4	62	1,50	4
ULC4X08010SNT200	-	8,0	8	9	30	7,2	68	2,00	4
ULC4X10010SNT200	-	10,0	10	11	38	9,0	80	2,00	4
ULC4X12010SNT300	-	12,0	12	13	46	11,0	93	3,00	4



Multi flute torical end mill; 50° helix; DIN6527L; long reach; AlCrN-based
 Torusfräser multi Schneiden; 50° Drallwinkel; DIN6527L; abgesetzter Schaft, AlCrN-basierte Schicht

Specifications / Spezifikationen



DIN 6535 HA	DIN 6535 HB	Dc	Ds	Lc	Ln	Dn	Lt	r	z
ULC6L03050SNT03	-	3,0	6,0	8	14	2,8	57	0,30	6
ULC6L04050SNT03	-	4,0	6,0	11	16	3,8	57	0,30	6
ULC6L05050SNT03	-	5,0	6,0	13	18	4,8	57	0,30	6
ULC6L06050SNT05	-	6,0	6,0	13	19	5,7	57	0,50	6
ULC6L08050SNT05	-	8,0	8,0	19	25	7,6	63	0,50	6
ULC6L10050SNT10	-	10,0	10,0	22	30	9,5	72	1,00	6
ULC6L12050SNT10	-	12,0	12,0	26	36	11,5	83	1,00	6
ULC8L16050SNT10	-	16,0	16,0	32	42	15,5	92	1,00	8
ULC10L20050SNT20	-	20,0	20,0	38	52	19,5	104	2,00	10



Multi flute end mill; 50° helix; SCT norm; long length; AlCrN-based
 Torusfräser multi Schneiden; 50° Drallwinkel; SCT Norm; lange Ausführung, AlCrN-basierte Schicht

Specifications / Spezifikationen



DIN 6535 HA	DIN 6535 HB	Dc	Ds	Lc	Ln	Dn	Lt	c	z
ULC6X06050S	-	6,0	6,0	18	-	-	62	0,10	6
ULC6X08050S	-	8,0	8,0	24	-	-	68	0,10	6
ULC6X10050S	-	10,0	10,0	30	-	-	80	0,10	6
ULC6X12050S	-	12,0	12,0	36	-	-	93	0,15	6
ULC8X16050S	-	16,0	16,0	48	-	-	108	0,15	8
ULC10X20050S	-	20,0	20,0	60	-	-	126	0,15	10



Multi flute torical end mill; 50° helix; SCT norm; long reach; AlCrN-based
 Torusfräser multi Schneiden; 50° Drallwinkel; SCT Norm; abgesetzter Schaft, AlCrN-basierte Schicht

Specifications / Spezifikationen

DIN 6535 HA	DIN 6535 HB	Dc	Ds	Lc	Ln	Dn	Lt	r	z
ULC6X06050SNT03	-	6,0	6,0	7	24	5,4	62	0,30	6
ULC6X06050SNT05	-	6,0	6,0	7	24	5,4	62	0,50	6
ULC6X06050SNT10	-	6,0	6,0	7	24	5,4	62	1,00	6
ULC6X08050SNT03	-	8,0	8,0	9	30	7,2	68	0,30	6
ULC6X08050SNT05	-	8,0	8,0	9	30	7,2	68	0,50	6
ULC6X08050SNT10	-	8,0	8,0	9	30	7,2	68	1,00	6
ULC6X10050SNT03	-	10,0	10,0	11	38	9,0	80	0,30	6
ULC6X10050SNT05	-	10,0	10,0	11	38	9,0	80	0,50	6
ULC6X10050SNT10	-	10,0	10,0	11	38	9,0	80	1,00	6
ULC6X10050SNT20	-	10,0	10,0	11	38	9,0	80	2,00	6
ULC6X12050SNT03	-	12,0	12,0	13	46	11,0	93	0,30	6
ULC6X12050SNT05	-	12,0	12,0	13	46	11,0	93	0,50	6
ULC6X12050SNT10	-	12,0	12,0	13	46	11,0	93	1,00	6
ULC6X12050SNT20	-	12,0	12,0	13	46	11,0	93	2,00	6
ULC8X16050SNT10	-	16,0	16,0	17	58	15,0	108	1,00	8
ULC8X16050SNT20	-	16,0	16,0	17	58	15,0	108	2,00	8
ULC10X20050SNT10	-	20,0	20,0	21	70	19,0	126	1,00	10
ULC10X20050SNT20	-	20,0	20,0	21	70	19,0	126	2,00	10



2 flute ball nose end mill; 15° helix; DIN6527S; short length; AlCrN-based
 Radiusfräser 2 Schneiden; 15° Drallwinkel; DIN6527K; kurze Ausführung; AlCrN-basierte Schicht

Specifications / Spezifikationen



DIN 6535 HA	DIN 6535 HB	Dc	Ds	Lc	Ln	Dn	Lt	r	z
ULC2S03015B	-	3,0	6	4	9	2,8	50	1,50	2
ULC2S04015B	-	4,0	6	5	13	3,8	54	2,00	2
ULC2S05015B	-	5,0	6	6	16	4,8	54	2,50	2
ULC2S06015B	-	6,0	6	7	17	5,7	54	3,00	2
ULC2S08015B	-	8,0	8	9	21	7,6	58	4,00	2
ULC2S10015B	-	10,0	10	11	25	9,5	66	5,00	2
ULC2S12015B	-	12,0	12	13	27	11,5	73	6,00	2



2 flute ball nose end mill; 15° helix; SCT norm; long reach; AlCrN-based
 Radiusfräser 2 Schneiden; 15° Drallwinkel; SCT Norm; abgesetzter Schaft; AlCrN-basierte Schicht

Specifications / Spezifikationen



DIN 6535 HA	DIN 6535 HB	Dc	Ds	Lc	Ln	Dn	Lt	r	z
ULC2X03015B	-	3,0	6	4	15	2,8	57	1,50	2
ULC2X04015B	-	4,0	6	5	16	3,8	57	2,00	2
ULC2X05015B	-	5,0	6	6	20	4,8	57	2,50	2
ULC2X06015B	-	6,0	6	7	24	5,7	62	3,00	2
ULC2X08015B	-	8,0	8	9	30	7,6	68	4,00	2
ULC2X10015B	-	10,0	10	11	38	9,5	80	5,00	2
ULC2X12015B	-	12,0	12	13	46	11,5	93	6,00	2



2 flute torical end mill; 30° helix; SCT norm; short length; TiAINSi
 Torusfräser 2 Schneiden; 30° Drallwinkel; SCT Norm; kurze Ausführung; TiAINSi

Specifications / Spezifikationen



NEW / NEU
 MICRO

DIN 6535 HA	DIN 6535 HB	Dc	Ds	Lc	Ln	Dn	Lt	r	z
ULC2S00230T005	-	0,2	4	0,2	-	-	50	0,05	2
ULC2S00330T005	-	0,3	4	0,3	-	-	50	0,05	2
ULC2S00430T010	-	0,4	4	0,4	-	-	50	0,10	2
ULC2S00530T010	-	0,5	4	0,5	-	-	50	0,10	2
ULC2S00630T010	-	0,6	4	0,6	-	-	50	0,10	2
ULC2S00830T010	-	0,8	4	0,8	-	-	50	0,10	2
ULC2S01030T020	-	1,0	4	1,0	-	-	50	0,20	2
ULC2S01530T020	-	1,5	4	1,5	-	-	50	0,20	2
ULC2S02030T020	-	2,0	4	2,0	-	-	50	0,20	2
ULC2S02030T050	-	2,0	4	2,0	-	-	50	0,50	2



2 flute torical end mill; 30° helix; SCT norm; long reach; TiAlNSi
Torusfräser 2 Schneiden; 30° Drallwinkel; SCT Norm; abgesetzter Schaft; TiAlNSi
Specifications / Spezifikationen

NEW / NEU
M I C R O

DIN 6535 HA	DIN 6535 HB	Dc	Ds	Lc	Ln	Dn	Lt	r	z
ULC2S00230N004T005	-	0,2	4	0,2	0,4	0,17	50	0,05	2
ULC2S00230N006T005	-	0,2	4	0,2	0,6	0,17	50	0,05	2
ULC2S00330N006T005	-	0,3	4	0,3	0,6	0,27	50	0,05	2
ULC2S00330N009T005	-	0,3	4	0,3	0,9	0,27	50	0,05	2
ULC2S00330N015T005	-	0,3	4	0,3	1,5	0,27	50	0,05	2
ULC2S00430N015T010	-	0,4	4	0,4	1,5	0,37	50	0,10	2
ULC2S00430N030T010	-	0,4	4	0,4	3,0	0,37	50	0,10	2
ULC2S00430N050T010	-	0,4	4	0,4	5,0	0,37	50	0,10	2
ULC2S00530N015T010	-	0,5	4	0,5	1,5	0,46	50	0,10	2
ULC2S00530N030T010	-	0,5	4	0,5	3,0	0,46	50	0,10	2
ULC2S00530N050T010	-	0,5	4	0,5	5,0	0,46	50	0,10	2
ULC2S00530N100T010	-	0,5	4	0,5	10,0	0,46	50	0,10	2
ULC2S00630N030T010	-	0,6	4	0,6	3,0	0,56	50	0,10	2
ULC2S00630N050T010	-	0,6	4	0,6	5,0	0,56	50	0,10	2
ULC2S00630N100T010	-	0,6	4	0,6	10,0	0,56	50	0,10	2
ULC2S00830N030T010	-	0,8	4	0,8	3,0	0,74	50	0,10	2
ULC2S00830N050T010	-	0,8	4	0,8	5,0	0,74	50	0,10	2
ULC2S00830N100T010	-	0,8	4	0,8	10,0	0,74	50	0,10	2
ULC2S00830N150T010	-	0,8	4	0,8	15,0	0,74	50	0,10	2
ULC2S01030N050T020	-	1,0	4	1,0	5,0	0,94	50	0,20	2
ULC2S01030N100T020	-	1,0	4	1,0	10,0	0,94	50	0,20	2
ULC2S01030N150T020	-	1,0	4	1,0	15,0	0,94	50	0,20	2
ULC2S01030N200T020	-	1,0	4	1,0	20,0	0,94	75	0,20	2
ULC2S01030N250T020	-	1,0	4	1,0	25,0	0,94	75	0,20	2
ULC2S01530N050T020	-	1,5	4	1,5	5,0	1,44	50	0,20	2
ULC2S01530N100T020	-	1,5	4	1,5	10,0	1,44	50	0,20	2
ULC2S01530N150T020	-	1,5	4	1,5	15,0	1,44	50	0,20	2
ULC2S01530N200T020	-	1,5	4	1,5	20,0	1,44	75	0,20	2
ULC2S01530N250T020	-	1,5	4	1,5	25,0	1,44	75	0,20	2
ULC2S02030N050T020	-	2,0	4	2,0	5,0	1,94	50	0,20	2
ULC2S02030N050T050	-	2,0	4	2,0	5,0	1,94	50	0,50	2
ULC2S02030N100T020	-	2,0	4	2,0	10,0	1,94	50	0,20	2
ULC2S02030N100T050	-	2,0	4	2,0	10,0	1,94	50	0,50	2
ULC2S02030N150T020	-	2,0	4	2,0	15,0	1,94	50	0,20	2
ULC2S02030N150T050	-	2,0	4	2,0	15,0	1,94	50	0,50	2
ULC2S02030N200T020	-	2,0	4	2,0	20,0	1,94	75	0,20	2
ULC2S02030N200T050	-	2,0	4	2,0	20,0	1,94	75	0,50	2
ULC2S02030N250T020	-	2,0	4	2,0	25,0	1,94	75	0,20	2
ULC2S02030N250T050	-	2,0	4	2,0	25,0	1,94	75	0,50	2
ULC2S02030N300T020	-	2,0	4	2,0	30,0	1,94	75	0,20	2
ULC2S02030N300T050	-	2,0	4	2,0	30,0	1,94	75	0,50	2
ULC2S02030N400T020	-	2,0	4	2,0	40,0	1,94	75	0,20	2
ULC2S02030N400T050	-	2,0	4	2,0	40,0	1,94	75	0,50	2



Other dimensions on request / Andere Abmessungen auf Anfrage

Dimensions in mm / Maße in mm

2 flute ballnose end mill; 30° helix; SCT norm; short length; TiAINSi
 Radiusfräser 2 Schneiden; 30° Drallwinkel; SCT Norm; kurze Ausführung; TiAINSi

Specifications / Spezifikationen



NEW / NEU
 MICRO

DIN 6535 HA	DIN 6535 HB	Dc	Ds	Lc	Ln	Dn	Lt	r	z
ULC2S00230B	-	0,2	4	0,2	-	-	50	0,10	2
ULC2S00330B	-	0,3	4	0,3	-	-	50	0,15	2
ULC2S00430B	-	0,4	4	0,4	-	-	50	0,20	2
ULC2S00530B	-	0,5	4	0,5	-	-	50	0,25	2
ULC2S00630B	-	0,6	4	0,6	-	-	50	0,30	2
ULC2S00830B	-	0,8	4	0,8	-	-	50	0,40	2
ULC2S01030B	-	1,0	4	1,0	-	-	50	0,50	2
ULC2S01530B	-	1,5	4	1,5	-	-	50	0,75	2
ULC2S02030B	-	2,0	4	2,0	-	-	50	1,00	2



2 flute ballnose end mill; 30° helix; SCT norm; long reach; TiAlN
 Radiusfräser 2 Schneiden; 30° Drallwinkel; SCT Norm; abgesetzter Schaft; TiAlN

Specifications / Spezifikationen

NEW / NEU
M I C R O

DIN 6535 HA	DIN 6535 HB	Dc	Ds	Lc	Ln	Dn	Lt	r	z
ULC2S00230N004B	-	0,2	4	0,2	0,4	0,17	50	0,10	2
ULC2S00230N006B	-	0,2	4	0,2	0,6	0,17	50	0,10	2
ULC2S00330N006B	-	0,3	4	0,3	0,6	0,27	50	0,15	2
ULC2S00330N009B	-	0,3	4	0,3	0,9	0,27	50	0,15	2
ULC2S00330N015B	-	0,3	4	0,3	1,5	0,27	50	0,15	2
ULC2S00430N015B	-	0,4	4	0,4	1,5	0,37	50	0,20	2
ULC2S00430N030B	-	0,4	4	0,4	3,0	0,37	50	0,20	2
ULC2S00430N050B	-	0,4	4	0,4	5,0	0,37	50	0,20	2
ULC2S00530N030B	-	0,5	4	0,5	3,0	0,46	50	0,25	2
ULC2S00530N050B	-	0,5	4	0,5	5,0	0,46	50	0,25	2
ULC2S00630N030B	-	0,6	4	0,6	3,0	0,56	50	0,30	2
ULC2S00630N050B	-	0,6	4	0,6	5,0	0,56	50	0,30	2
ULC2S00830N030B	-	0,8	4	0,8	3,0	0,74	50	0,40	2
ULC2S00830N050B	-	0,8	4	0,8	5,0	0,74	50	0,40	2
ULC2S01030N050B	-	1,0	4	1,0	5,0	0,94	50	0,50	2
ULC2S01030N100B	-	1,0	4	1,0	10,0	0,94	50	0,50	2
ULC2S01030N150B	-	1,0	4	1,0	15,0	0,94	50	0,50	2
ULC2S01030N200B	-	1,0	4	1,0	20,0	0,94	75	0,50	2
ULC2S01030N250B	-	1,0	4	1,0	25,0	0,94	75	0,50	2
ULC2S01530N050B	-	1,5	4	1,5	5,0	1,44	50	0,75	2
ULC2S01530N100B	-	1,5	4	1,5	10,0	1,44	50	0,75	2
ULC2S01530N150B	-	1,5	4	1,5	15,0	1,44	50	0,75	2
ULC2S01530N200B	-	1,5	4	1,5	20,0	1,44	75	0,75	2
ULC2S01530N250B	-	1,5	4	1,5	25,0	1,44	75	0,75	2
ULC2S01530N300B	-	1,5	4	1,5	30,0	1,44	75	0,75	2
ULC2S02030N050B	-	2,0	4	2,0	5,0	1,94	50	1,00	2
ULC2S02030N100B	-	2,0	4	2,0	10,0	1,94	50	1,00	2
ULC2S02030N150B	-	2,0	4	2,0	15,0	1,94	50	1,00	2
ULC2S02030N200B	-	2,0	4	2,0	20,0	1,94	75	1,00	2
ULC2S02030N300B	-	2,0	4	2,0	30,0	1,94	75	1,00	2
ULC2S02030N400B	-	2,0	4	2,0	40,0	1,94	75	1,00	2





ULTRA-X LINE
SOLID CARBIDE END MILLS ®



Improving Quality Through Innovation

Product of Holland

UK

▶ Technical information Solid Carbide End Mills

D

▶ Technische Informationen VHM Fräser

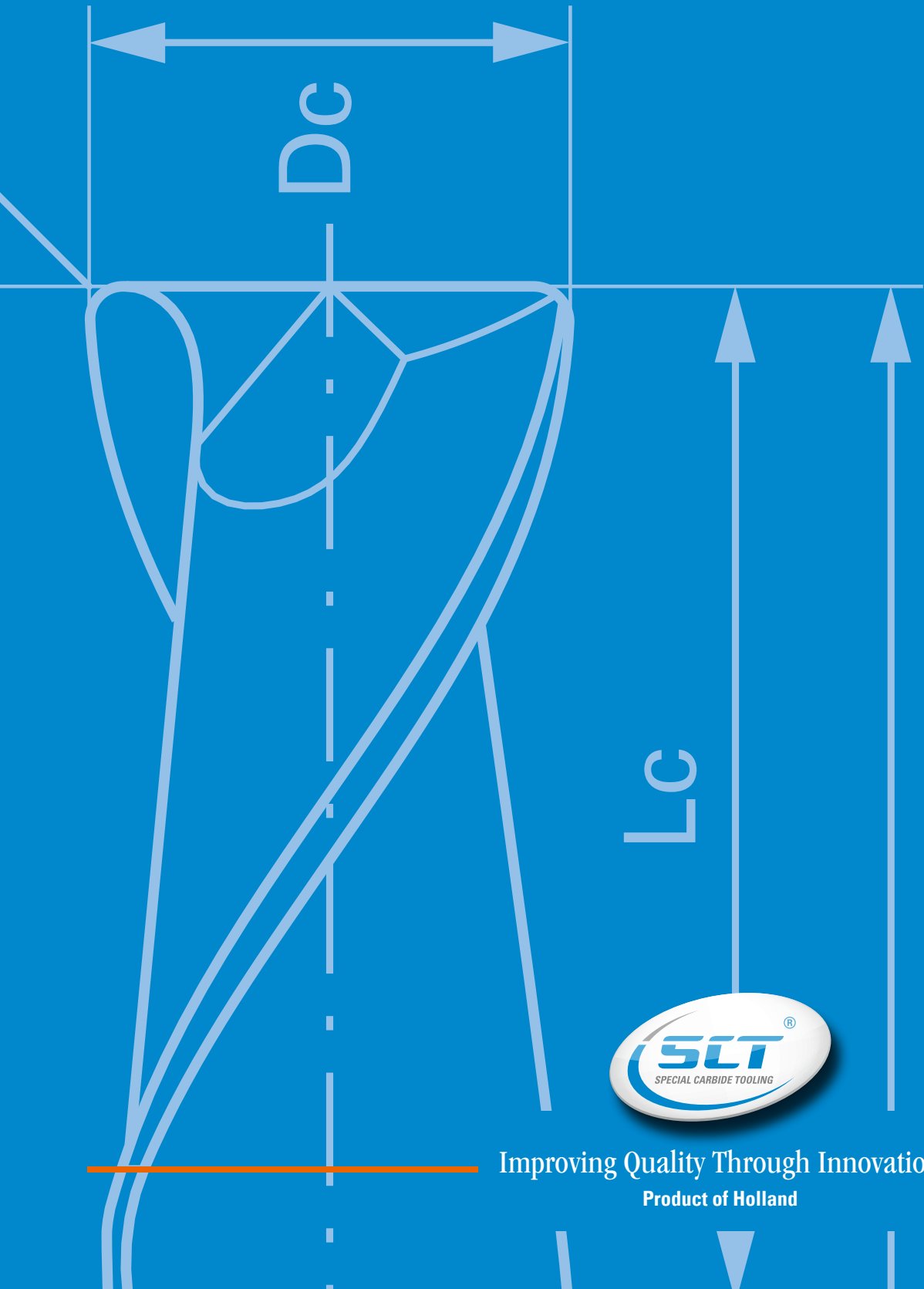

Improving Quality Through Innovation

Product of Holland

Shank and adapter specifications

Schaft und Spannflächen Spezifikation

Cylindrical shank DIN 6535 form HA and HB / Zylinderschaft nach DIN 6535 Form HA und HB

without flat ohne Spannfläche		with flat mit Spannfläche			
d_{1h6}	L_1	b_1	h_{1h11}	L_1	L_2
6	36	4,2	5,1	36	18,0
8	36	5,5	6,9	36	18,0
10	40	7,0	8,5	40	20,0
12	45	8,0	10,4	45	22,5
14	45	8,0	12,7	45	22,5
16	48	10,0	14,2	48	24,0
18	48	10,0	16,2	48	24,0
20	50	11,0	18,2	50	25,0

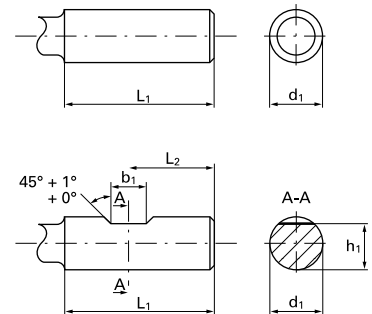

Cylindrical shank DIN 6535 form HA and HB / Zylinderschaft nach DIN 6535 Form HA und HB

without flat ohne Spannfläche		with flat mit Spannfläche				
d_{1h6}	L_1	b_1	h_{1h11}	L_1	L_2	f_1
25	56	12,0	23,0	56	32,0	17
32	60	14,0	30,0	60	35,0	19

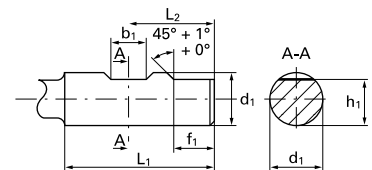

Adapter type DIN 1835 form B / Werkzeughalter Typ DIN 1835 Form B

d_{1h5}	d_2	d_3	d_4	f_1	L_3
6	25	M6	8	1,0	35
8	28	M8	10	1,3	35
10	35	M10	12	1,5	39
12	42	M12	14	1,6	44
14	44	M12	14	1,6	44
16	48	M14	16	1,7	47
18	50	M14	16	1,7	47
20	52	M16	18	2,1	49

Screw size/opt. torque Schraube/ opt. Drehmoment

M6	5 Nm
M8	10 Nm
M10	16 Nm
M12	28 Nm
M14	42 Nm
M16	50 Nm

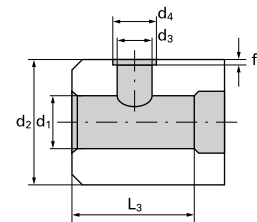

Adapter type DIN 1835 form B / Werkzeughalter Typ DIN 1835 Form B

d_{1h5}	d_2	d_3	d_4	f_1	L_3
25	65	M18	20	2,1	54
32	72	M20	22	2,2	58

Screw size/opt. torque Schraube/ opt. Drehmoment

M18	60 Nm
M20	60 Nm

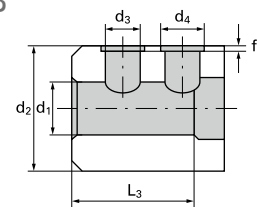

End mill specifications Fräser Spezifikationen

List of abbreviations / Bedeutung der Abkürzungen

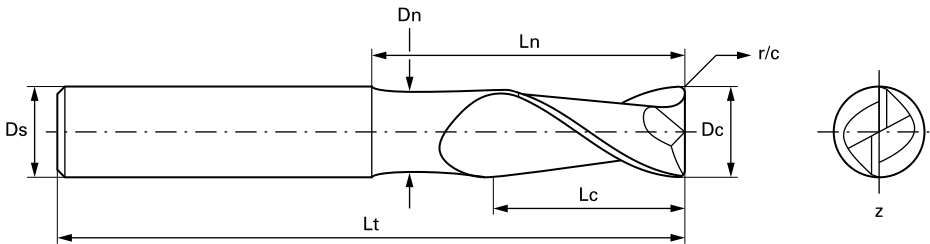

- Dc** Cutting diameter / Durchmesser Schneide
Ds Shank diameter / Durchmesser Schaft
Dn Neck diameter / Durchmesser Freischliff
Lc Length of cut / Schneidelänge
Lt Total length / Gesamtlänge
Ln Length of neck / Freischlifflänge
z Number of teeth / Schneiden
r Radius dimension / Eckenradius
c Chamfer dimension / Eckenfase

Tolerances according to DIN 7160 and 7161 / Toleranz nach DIN 7160 und 7161

	$\varnothing > 1 - 3$	$\varnothing > 3 - 6$	$\varnothing > 6 - 10$	$\varnothing > 10 - 18$	$\varnothing > 18 - 30$
e8	-0,014 -0,028	-0,020 -0,038	-0,025 -0,047	-0,032 -0,059	-0,040 -0,073
h10	0 -0,04	0 -0,048	0 -0,058	0 -0,07	0 -0,084
h5	0 -0,004	0 -0,005	0 -0,006	0 -0,008	0 -0,009
h6	0 -0,006	0 -0,008	0 -0,009	0 -0,011	0 -0,013

Problems and solutions

Anwendungsprobleme und Lösungsansätze

Thermal cracks / Wärmerisse

- Decrease feed per tooth [fz] / Reduzierung des Vorschubs pro Zahn [fz]
- Increase cutting speed [Vc] / Erhöhen der Schnittgeschwindigkeit [Vc]

Chipping of the cutting edges / Abplatzen der Schneidkanten

- Decrease feed per tooth [fz] / Reduzierung des Vorschubs pro Zahn [fz]
- Control rigidity machine, workpiece and fixture / Kontrolle der Maschinenfestigkeit des Werkstücks und der Aufnahmevorrichtung
- Change to climb milling / Wechsel zu Gegenlaufräsen
- Minimize overhang / Überstand reduzieren

Fatal breakage / Schwerer Bruch

- Increase cutting speed [Vc] / Erhöhen der Schnittgeschwindigkeit [Vc]
- Decrease feed per tooth [fz] / Reduzierung des Vorschubs pro Zahn [fz]
- Decrease depth of cut [Ap] / Reduzierung der Schnitttiefe [Ap]
- Minimize overhang / Überstand reduzieren
- Optimize chipflow by coolant or air pressure / Optimierung des Spanabflusses durch Kühlmittel oder Luftdruck
- Decrease width of cut [Ae] / Reduzierung der Schnittbreite [Ae]

Wear on relief angle / Abnutzung am Freiwinkel

- Increase feed per tooth [fz] / Erhöhen Reduzierung des Vorschubs pro Zahn [fz]
- Decrease cutting speed [Vc] / Reduzierung der Schnittgeschwindigkeit [Vc]
- Use coated grade / Einsatz beschichteter Werkzeuge

Built up edge / Aufbauschneide

- Increase cutting speed [Vc] / Erhöhen der Schnittgeschwindigkeit [Vc]
- Increase feed per tooth [fz] / Erhöhen Reduzierung des Vorschubs pro Zahn [fz]
- Optimize coolant flow / Optimierung des Kühlmittelflusses
- Check emulsion percentage / Überprüfung des Emulsionsgehalts

Chattering / Rattern

- Optimize workpiece fixture / Optimierung der Werkstückaufnahme
- Change to climb milling / Wechsel zu Gegenlaufräsen
- Change to other cutting geometry / Wechsel zu anderer Schneidgeometrie
- Decrease metal removal rate [Q] / Reduzierung der Zerspanungsleistung [Q]

Bad workpiece surface / Schlechte Werkstückoberfläche

- Increase cutting speed [Vc] / Erhöhen der Schnittgeschwindigkeit [Vc]
- Optimize rigidity / Optimierung der Eigensteifigkeit
- Use multi-flute end mills / Benutzung von Schafffräser multi Schneiden
- Use higher helix geometries / Benutzung höherer Drallwinkel

Cutting formulas Zerspanungsformeln

Cutting speed / Schnittgeschwindigkeit

$$V_c = \frac{D_c \times \pi \times n}{1000} \quad [\text{m/min}]$$

- V_c** Cutting speed [m/min] / Schnittgeschwindigkeit [m/min]
D_c Cutting diameter [mm] / Durchmesser Schneide [mm]
n Revolutions per minute / Umdrehungen pro Minute
π Pi / Pi

Revolutions per minute / Umdrehungen

$$n = \frac{V_c \times 1000}{D_c \times \pi} \quad [\text{r.p.m.}]$$

- V_c** Cutting speed [m/min] / Schnittgeschwindigkeit [m/min]
D_c Cutting diameter [mm] / Durchmesser Schneide [mm]
n Revolutions per minute / Umdrehungen pro Minute
π Pi / Pi

Table feed rate / Tischvorschub

$$V_f = f_z \times z \times n \quad [\text{mm/min}]$$

- V_f** Table feed [mm/min] / Tischvorschub [mm/min]
f_z Feed per tooth [mm] / Vorschub pro Zahn [mm]
z Number of teeth / Schneiden
n Revolutions per minute / Umdrehungen pro Minute

Feed per tooth / Vorschub pro Zahn

$$f_z = \frac{V_f}{z \times n} \quad [\text{mm}]$$

- f_z** Feed per tooth [mm] / Vorschub pro Zahn [mm]
V_f Table feed [mm/min] / Tischvorschub [mm/min]
z Number of teeth / Schneiden
n Revolutions per minute / Umdrehungen pro Minute

Metal removal rate / Zerspanungsvolumen

$$Q = \frac{A_p \times A_e \times V_f}{1000} \quad [\text{cm}^3/\text{min}]$$

- Q** Metal removal rate [cm³/min] / Zerspanungsvolumen [cm³/min]
A_p Depth of cut [mm] / Schnitttiefe [mm]
A_e Width of cut [mm] / Schnittbreite [mm]
V_f Table feed [mm/min] / Tischvorschub [mm/min]

Ball nose formulas Radiusfräser Zerspanungsformeln

Calculation R_{th} / Berechnung R_{th}

$$R_{th} = \frac{d_1}{2} - \frac{\sqrt{d_1^2 - A_e^2}}{4}$$

- d_1** Cutting diameter [mm] / Durchmesser Schneide [mm]
 R_{th} Theoretical roughness [mm] / Theoretische Rauhtiefe [mm]
 A_e Steps [mm] / Schnittbreite [mm]

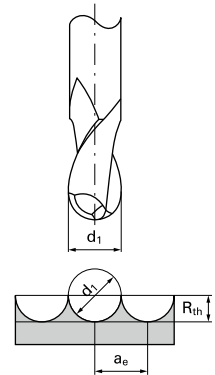

Calculation A_e / Berechnung A_e

$$A_e = 2\sqrt{R_{th}(d_1 - R_{th})}$$

- d_1** Cutting diameter [mm] / Durchmesser Schneide [mm]
 R_{th} Theoretical roughness [mm] / Theoretische Rauhtiefe [mm]
 A_e Steps [mm] / Schnittbreite [mm]

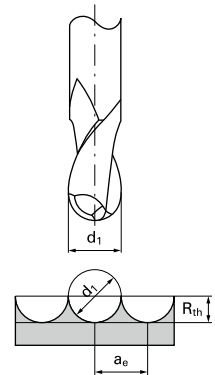

Calculation d_{eff} / Berechnung d_{eff}

$$D_{eff} = 2\sqrt{A_p(d_1 - A_p)}$$

- d_1** Cutting diameter [mm] / Durchmesser Schneide [mm]
 R_{eff} Effective cutting diameter [mm] / Effektiver Durchmesser [mm]
 A_p Depth of cut [mm] / Schnitttiefe [mm]

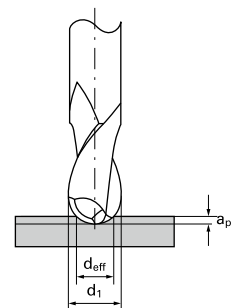

Legenda

Legende

	Material-coating combination Material-Beschichtung Kombination		Ballnose Vollradius
	Specific tool geometry Spezifische Werkzeuggeometrie		Oil coolant Öl-Kühlung
	Semi-specific tool geometry Halb spezifische Werkzeuggeometrie		Air coolant Luft-Kühlung
	Universal tool geometry Universal-Werkzeuggeometrie		Minimal lubrication Minimal Schmierung
	Geometry for high hard cutting Werkzeuggeometrie für Hartbearbeitung		Material group Materialgruppe
	Rake angle / Spannwinkel Helix angle / Drallwinkel		Finishing operation Schlichtbearbeitung
	Feed movement Vorschubrichtung		Universal operation Universal-Bearbeitung
	Tolerance cutting diameter Toleranz Durchmesser Schneide		Roughing operation Schruppbearbeitung
	Tolerance shank diameter Toleranz Durchmesser Schaft		
	Shank design Schaftausführung		
	90° Sharp-edge end face 90° Stirn Ausführung		
	Chamfer Eckenfase		
	Corner radius Eckenradius		

UK D



- ▶ Short and long drills / Kurze und lange Spiralbohrer
- ▶ NC Spot drills / NC - Anbohrer
- ▶ Uncoated / Unbeschichtet



Improving Quality Through Innovation

Product of Holland

Table of contents
Inhaltsverzeichnis

Solid carbide drill; DIN6539; short length; uncoated
VHM Bohrer; DIN6539; kurze Ausführung; unbeschichtet

4 - 7



Solid carbide drill; SCT norm; long length; uncoated
VHM Bohrer; SCT Norm; lange Ausführung; unbeschichtet

8 - 11



Solid carbide NC spot drill 90°; SCT norm; long length; uncoated
VHM NC Anbohrer 90°; SCT Norm; lange Ausführung; unbeschichtet

12 - 13



Solid carbide NC spot drill 120°; SCT norm; long length; uncoated
VHM NC Anbohrer 120°; SCT Norm; lange Ausführung; unbeschichtet

14 - 15



Solid carbide drill; DIN6539; short length; uncoated

VHM Bohrer; DIN6539; kurze Ausführung; unbeschichtet

Workpiece material groups and cutting speed / Werkstoffgruppen und Schnittgeschwindigkeiten

Material Material	Tensile strength Zugfestigkeit Rm [N/mm ²]	Hardness Härte [HB/HRC]	Cutting speed Vc [m/min] Schnittgeschwindigkeiten		
			min	opt	max
P1 Plain carbon steel / Unlegierter Stahl	< 600	< 230	60	70	80
P2 Alloy Steel / Legierter Stahl	< 1200	< 350	50	60	70
P3 High alloy steel and tool steel / Hochlegierter Stahl und Werkzeugstahl	< 1400	< 380	-	-	-
M1 Aust. and Ferr. Stainless steel / Aust. und Ferr. rostfreie Stähle	< 680	< 220	20	25	30
M2 Mart. Stainless steel / Mart. rostfreie Stähle	< 820	< 240	20	25	30
K1 Grey cast iron / Grauguß	-	< 280	70	80	90
K2 Ductile cast iron / Sphäroguß	-	< 320	60	70	80
N1 Non-ferrous alloys / Nichteisenmetalle	< 250	< 110	120	160	200
N2 Aluminium alloys / Aluminiumlegierungen	< 530	< 130	170	200	230
S1 High temperature alloys Fe, Ni and Co based / Warmfeste Leg. Fe, Ni und Co	< 3300	< 350	10	15	20
S2 Titanium alloys; Alpha and Beta / Titan Legierungen Alpha und Beta	< 2100	< 400	10	15	20
H1 Hardened steel / Gehärtete Stähle	-	< 54 HRC	-	-	-
H2 Hardened steel / Gehärtete Stähle	-	52-60 HRC	-	-	-
H3 Hardened steel / Gehärtete Stähle	-	> 58 HRC	-	-	-
G1 Graphite / Graphit	-	-	-	-	-

Cutting conditions / Zerspanungswerte

Material Material	f Feed per revolution [mm] / Vorschub pro Umdrehung [mm]										
	Ø 0 - 2	Ø 2 - 2,5	Ø 2,5 - 3	Ø 3 - 4	Ø 4 - 5	Ø 5 - 6	Ø 6 - 8	Ø 8 - 10	Ø 10 - 12	Ø 12 - 16	Ø 16 - 20
P1	0,080	0,100	0,125	0,160	0,160	0,200	0,250	0,315	0,315	0,400	0,500
P2	0,063	0,080	0,100	0,125	0,125	0,160	0,200	0,250	0,250	0,315	0,400
P3	0,050	0,063	0,080	0,100	0,100	0,125	0,160	0,200	0,200	0,250	0,315
M1	0,040	0,050	0,063	0,080	0,080	0,100	0,125	0,160	0,160	0,200	0,250
M2	0,032	0,040	0,050	0,063	0,063	0,080	0,100	0,125	0,125	0,160	0,200
K1	0,125	0,160	0,160	0,200	0,250	0,315	0,315	0,400	0,500	0,630	0,630
K2	0,100	0,125	0,160	0,200	0,200	0,250	0,315	0,400	0,400	0,500	0,630
N1	0,100	0,125	0,160	0,200	0,200	0,250	0,315	0,400	0,400	0,500	0,630
N2	0,125	0,160	0,160	0,200	0,250	0,315	0,315	0,400	0,500	0,630	0,630
S1	0,040	0,050	0,063	0,080	0,080	0,100	0,125	0,160	0,160	0,200	0,250
S2	0,032	0,040	0,050	0,063	0,063	0,080	0,100	0,125	0,125	0,160	0,200
H1	0,032	0,040	0,050	0,063	0,063	0,080	0,100	0,125	0,125	0,160	0,200
H2	0,025	0,032	0,040	0,050	0,050	0,063	0,080	0,100	0,100	0,125	0,160
H3	-	-	-	-	-	-	-	-	-	-	-
G1	-	-	-	-	-	-	-	-	-	-	-

Solid carbide drill; DIN6539; short length; uncoated
VHM Bohrer; DIN6539; kurze Ausführung; unbeschichtet
Specifications / Spezifikationen

DIN 6535 HA	DIN 6535 HE	Dc	Ds	Ls	Ln	Dn	Lt	r	z
FLDC2S015030S	-	1,5	1,5	9	-	-	32	-	2
FLDC2S016030S	-	1,6	1,6	10	-	-	34	-	2
FLDC2S020030S	-	2,0	2,0	12	-	-	38	-	2
FLDC2S021030S	-	2,1	2,1	12	-	-	38	-	2
FLDC2S022030S	-	2,2	2,2	13	-	-	40	-	2
FLDC2S023030S	-	2,3	2,3	13	-	-	40	-	2
FLDC2S024030S	-	2,4	2,4	14	-	-	43	-	2
FLDC2S025030S	-	2,5	2,5	14	-	-	43	-	2
FLDC2S026030S	-	2,6	2,6	14	-	-	43	-	2
FLDC2S027030S	-	2,7	2,7	16	-	-	46	-	2
FLDC2S028030S	-	2,8	2,8	16	-	-	46	-	2
FLDC2S029030S	-	2,9	2,9	16	-	-	46	-	2
FLDC2S030030S	-	3,0	3,0	16	-	-	46	-	2
FLDC2S031030S	-	3,1	3,1	18	-	-	49	-	2
FLDC2S032030S	-	3,2	3,2	18	-	-	49	-	2
FLDC2S033030S	-	3,3	3,3	18	-	-	49	-	2
FLDC2S034030S	-	3,4	3,4	20	-	-	52	-	2
FLDC2S035030S	-	3,5	3,5	20	-	-	52	-	2
FLDC2S036030S	-	3,6	3,6	20	-	-	52	-	2
FLDC2S037030S	-	3,7	3,7	20	-	-	52	-	2
FLDC2S038030S	-	3,8	3,8	22	-	-	55	-	2
FLDC2S039030S	-	3,9	3,9	22	-	-	55	-	2
FLDC2S040030S	-	4,0	4,0	22	-	-	55	-	2
FLDC2S041030S	-	4,1	4,1	22	-	-	55	-	2
FLDC2S042030S	-	4,2	4,2	22	-	-	55	-	2
FLDC2S043030S	-	4,3	4,3	24	-	-	58	-	2
FLDC2S044030S	-	4,4	4,4	24	-	-	58	-	2
FLDC2S045030S	-	4,5	4,5	24	-	-	58	-	2
FLDC2S046030S	-	4,6	4,6	24	-	-	58	-	2
FLDC2S047030S	-	4,7	4,7	24	-	-	58	-	2
FLDC2S048030S	-	4,8	4,8	26	-	-	62	-	2
FLDC2S049030S	-	4,9	4,9	26	-	-	62	-	2
FLDC2S050030S	-	5,0	5,0	26	-	-	62	-	2
FLDC2S052030S	-	5,2	5,2	26	-	-	62	-	2
FLDC2S055030S	-	5,5	5,5	28	-	-	66	-	2
FLDC2S058030S	-	5,8	5,8	28	-	-	66	-	2
FLDC2S060030S	-	6,0	6,0	28	-	-	66	-	2
FLDC2S065030S	-	6,5	6,5	31	-	-	70	-	2
FLDC2S068030S	-	6,8	6,8	34	-	-	74	-	2
FLDC2S070030S	-	7,0	7,0	34	-	-	74	-	2
FLDC2S075030S	-	7,5	7,5	34	-	-	74	-	2
FLDC2S080030S	-	8,0	8,0	37	-	-	79	-	2
FLDC2S085030S	-	8,5	8,5	37	-	-	79	-	2
FLDC2S088030S	-	8,8	8,8	40	-	-	84	-	2



Other dimensions on request / Andere Abmessungen auf Anfrage

Dimensions in mm / Maße in mm

Solid carbide drill; DIN6539; short length; uncoated

VHM Bohrer; DIN6539; kurze Ausführung; unbeschichtet

Workpiece material groups and cutting speed / Werkstoffgruppen und Schnittgeschwindigkeiten

Material Material	Tensile strength Zugfestigkeit Rm [N/mm ²]	Hardness Härte [HB/HRC]	Cutting speed Vc [m/min] Schnittgeschwindigkeiten		
			min	opt	max
P1 Plain carbon steel / Unlegierter Stahl	< 600	< 230	60	70	80
P2 Alloy Steel / Legierter Stahl	< 1200	< 350	50	60	70
P3 High alloy steel and tool steel / Hochlegierter Stahl und Werkzeugstahl	< 1400	< 380	-	-	-
M1 Aust. and Ferr. Stainless steel / Aust. und Ferr. rostfreie Stähle	< 680	< 220	20	25	30
M2 Mart. Stainless steel / Mart. rostfreie Stähle	< 820	< 240	20	25	30
K1 Grey cast iron / Grauguß	-	< 280	70	80	90
K2 Ductile cast iron / Sphäroguß	-	< 320	60	70	80
N1 Non-ferrous alloys / Nichteisenmetalle	< 250	< 110	120	160	200
N2 Aluminium alloys / Aluminiumlegierungen	< 530	< 130	170	200	230
S1 High temperature alloys Fe, Ni and Co based / Warmfeste Leg. Fe, Ni und Co	< 3300	< 350	10	15	20
S2 Titanium alloys; Alpha and Beta / Titan Legierungen Alpha und Beta	< 2100	< 400	10	15	20
H1 Hardened steel / Gehärtete Stähle	-	< 54 HRC	-	-	-
H2 Hardened steel / Gehärtete Stähle	-	52-60 HRC	-	-	-
H3 Hardened steel / Gehärtete Stähle	-	> 58 HRC	-	-	-
G1 Graphite / Graphit	-	-	-	-	-

Cutting conditions / Zerspanungswerte

Material Material	f Feed per revolution [mm] / Vorschub pro Umdrehung [mm]										
	Ø 0 - 2	Ø 2 - 2,5	Ø 2,5 - 3	Ø 3 - 4	Ø 4 - 5	Ø 5 - 6	Ø 6 - 8	Ø 8 - 10	Ø 10 - 12	Ø 12 - 16	Ø 16 - 20
P1	0,080	0,100	0,125	0,160	0,160	0,200	0,250	0,315	0,315	0,400	0,500
P2	0,063	0,080	0,100	0,125	0,125	0,160	0,200	0,250	0,250	0,315	0,400
P3	0,050	0,063	0,080	0,100	0,100	0,125	0,160	0,200	0,200	0,250	0,315
M1	0,040	0,050	0,063	0,080	0,080	0,100	0,125	0,160	0,160	0,200	0,250
M2	0,032	0,040	0,050	0,063	0,063	0,080	0,100	0,125	0,125	0,160	0,200
K1	0,125	0,160	0,160	0,200	0,250	0,315	0,315	0,400	0,500	0,630	0,630
K2	0,100	0,125	0,160	0,200	0,200	0,250	0,315	0,400	0,400	0,500	0,630
N1	0,100	0,125	0,160	0,200	0,200	0,250	0,315	0,400	0,400	0,500	0,630
N2	0,125	0,160	0,160	0,200	0,250	0,315	0,315	0,400	0,500	0,630	0,630
S1	0,040	0,050	0,063	0,080	0,080	0,100	0,125	0,160	0,160	0,200	0,250
S2	0,032	0,040	0,050	0,063	0,063	0,080	0,100	0,125	0,125	0,160	0,200
H1	0,032	0,040	0,050	0,063	0,063	0,080	0,100	0,125	0,125	0,160	0,200
H2	0,025	0,032	0,040	0,050	0,050	0,063	0,080	0,100	0,100	0,125	0,160
H3	-	-	-	-	-	-	-	-	-	-	-
G1	-	-	-	-	-	-	-	-	-	-	-

Solid carbide drill; DIN6539; short length; uncoated
 VHM Bohrer; DIN6539; kurze Ausführung; unbeschichtet

Specifications / Spezifikationen



DIN 6535 HA	DIN 6535 HE	Dc	Ds	Ls	Ln	Dn	Lt	r	z
FLDC2S090030S	-	9,0	9,0	40	-	-	84	-	2
FLDC2S095030S	-	9,5	9,5	40	-	-	84	-	2
FLDC2S100030S	-	10,0	10,0	43	-	-	89	-	2
FLDC2S102030S	-	10,2	10,2	43	-	-	89	-	2
FLDC2S105030S	-	10,5	10,5	43	-	-	89	-	2
FLDC2S110030S	-	11,0	11,0	47	-	-	95	-	2
FLDC2S115030S	-	11,5	11,5	47	-	-	95	-	2
FLDC2S120030S	-	12,0	12,0	51	-	-	102	-	2



Solid carbide drill; SCT norm; long length; uncoated

VHM Bohrer; SCT Norm; lange Ausführung; unbeschichtet

Workpiece material groups and cutting speed / Werkstoffgruppen und Schnittgeschwindigkeiten

Material Material	Tensile strength Zugfestigkeit Rm [N/mm ²]	Hardness Härte [HB/HRC]	Cutting speed Vc [m/min] Schnittgeschwindigkeiten		
			min	opt	max
P1 Plain carbon steel / Unlegierter Stahl	< 600	< 230	60	70	80
P2 Alloy Steel / Legierter Stahl	< 1200	< 350	50	60	70
P3 High alloy steel and tool steel / Hochlegierter Stahl und Werkzeugstahl	< 1400	< 380	-	-	-
M1 Aust. and Ferr. Stainless steel / Aust. und Ferr. rostfreie Stähle	< 680	< 220	20	25	30
M2 Mart. Stainless steel / Mart. rostfreie Stähle	< 820	< 240	20	25	30
K1 Grey cast iron / Grauguß	-	< 280	70	80	90
K2 Ductile cast iron / Sphäroguß	-	< 320	50	60	70
N1 Non-ferrous alloys / Nichteisenmetalle	< 250	< 110	120	160	200
N2 Aluminium alloys / Aluminiumlegierungen	< 530	< 130	170	200	230
S1 High temperature alloys Fe, Ni and Co based / Warmfeste Leg. Fe, Ni und Co	< 3300	< 350	10	15	20
S2 Titanium alloys; Alpha and Beta / Titan Legierungen Alpha und Beta	< 2100	< 400	10	15	20
H1 Hardened steel / Gehärtete Stähle	-	< 54 HRC	-	-	-
H2 Hardened steel / Gehärtete Stähle	-	52-60 HRC	-	-	-
H3 Hardened steel / Gehärtete Stähle	-	> 58 HRC	-	-	-
G1 Graphite / Graphit	-	-	-	-	-

Cutting conditions / Zerspanungswerte

Material Material	f Feed per revolution [mm] / Vorschub pro Umdrehung [mm]										
	Ø 0 - 2	Ø 2 - 2,5	Ø 2,5 - 3	Ø 3 - 4	Ø 4 - 5	Ø 5 - 6	Ø 6 - 8	Ø 8 - 10	Ø 10 - 12	Ø 12 - 16	Ø 16 - 20
P1	0,080	0,100	0,125	0,160	0,160	0,200	0,250	0,315	0,315	0,400	0,500
P2	0,063	0,080	0,100	0,125	0,125	0,160	0,200	0,250	0,250	0,315	0,400
P3	0,050	0,063	0,080	0,100	0,100	0,125	0,160	0,200	0,200	0,250	0,315
M1	0,040	0,050	0,063	0,080	0,080	0,100	0,125	0,160	0,160	0,200	0,250
M2	0,032	0,040	0,050	0,063	0,063	0,080	0,100	0,125	0,125	0,160	0,200
K1	0,125	0,160	0,160	0,200	0,250	0,315	0,315	0,400	0,500	0,630	0,630
K2	0,100	0,125	0,160	0,200	0,200	0,250	0,315	0,400	0,400	0,500	0,630
N1	0,100	0,125	0,160	0,200	0,200	0,250	0,315	0,400	0,400	0,500	0,630
N2	0,125	0,160	0,160	0,200	0,250	0,315	0,315	0,400	0,500	0,630	0,630
S1	0,040	0,050	0,063	0,080	0,080	0,100	0,125	0,160	0,160	0,200	0,250
S2	0,032	0,040	0,050	0,063	0,063	0,080	0,100	0,125	0,125	0,160	0,200
H1	0,032	0,040	0,050	0,063	0,063	0,080	0,100	0,125	0,125	0,160	0,200
H2	0,025	0,032	0,040	0,050	0,050	0,063	0,080	0,100	0,100	0,125	0,160
H3	-	-	-	-	-	-	-	-	-	-	-
G1	-	-	-	-	-	-	-	-	-	-	-

Solid carbide drill; SCT norm; long length; uncoated
VHM Bohrer; SCT Norm; lange Ausführung; unbeschichtet

Specifications / Spezifikationen

DIN 6535 HA	DIN 6535 HE	Dc	Ds	Ls	Ln	Dn	Lt	r	z
FLDC2L020030S	-	2,0	2,0	24	-	-	49	-	2
FLDC2L021030S	-	2,1	2,1	24	-	-	49	-	2
FLDC2L022030S	-	2,2	2,2	27	-	-	53	-	2
FLDC2L023030S	-	2,3	2,3	27	-	-	53	-	2
FLDC2L024030S	-	2,4	2,4	30	-	-	57	-	2
FLDC2L025030S	-	2,5	2,5	30	-	-	57	-	2
FLDC2L026030S	-	2,6	2,6	30	-	-	57	-	2
FLDC2L027030S	-	2,7	2,7	33	-	-	61	-	2
FLDC2L028030S	-	2,8	2,8	33	-	-	61	-	2
FLDC2L029030S	-	2,9	2,9	33	-	-	61	-	2
FLDC2L030030S	-	3,0	3,0	33	-	-	61	-	2
FLDC2L031030S	-	3,1	3,1	36	-	-	65	-	2
FLDC2L032030S	-	3,2	3,2	36	-	-	65	-	2
FLDC2L033030S	-	3,3	3,3	36	-	-	65	-	2
FLDC2L034030S	-	3,4	3,4	39	-	-	70	-	2
FLDC2L035030S	-	3,5	3,5	39	-	-	70	-	2
FLDC2L036030S	-	3,6	3,6	39	-	-	70	-	2
FLDC2L037030S	-	3,7	3,7	39	-	-	70	-	2
FLDC2L038030S	-	3,8	3,8	43	-	-	75	-	2
FLDC2L039030S	-	3,9	3,9	43	-	-	75	-	2
FLDC2L040030S	-	4,0	4,0	43	-	-	75	-	2
FLDC2L041030S	-	4,1	4,1	43	-	-	75	-	2
FLDC2L042030S	-	4,2	4,2	43	-	-	75	-	2
FLDC2L043030S	-	4,3	4,3	47	-	-	80	-	2
FLDC2L044030S	-	4,4	4,4	47	-	-	80	-	2
FLDC2L045030S	-	4,5	4,5	47	-	-	80	-	2
FLDC2L046030S	-	4,6	4,6	47	-	-	80	-	2
FLDC2L047030S	-	4,7	4,7	47	-	-	80	-	2
FLDC2L048030S	-	4,8	4,8	52	-	-	86	-	2
FLDC2L049030S	-	4,9	4,9	52	-	-	86	-	2
FLDC2L050030S	-	5,0	5,0	52	-	-	86	-	2
FLDC2L055030S	-	5,5	5,5	57	-	-	93	-	2
FLDC2L060030S	-	6,0	6,0	57	-	-	93	-	2
FLDC2L065030S	-	6,5	6,5	63	-	-	101	-	2
FLDC2L068030S	-	6,8	6,8	69	-	-	109	-	2
FLDC2L070030S	-	7,0	7,0	69	-	-	109	-	2
FLDC2L075030S	-	7,5	7,5	69	-	-	109	-	2
FLDC2L080030S	-	8,0	8,0	75	-	-	117	-	2
FLDC2L085030S	-	8,5	8,5	75	-	-	117	-	2
FLDC2L090030S	-	9,0	9,0	81	-	-	125	-	2
FLDC2L095030S	-	9,5	9,5	91	-	-	125	-	2
FLDC2L100030S	-	10,0	10,0	87	-	-	133	-	2
FLDC2L102030S	-	10,2	10,2	87	-	-	133	-	2
FLDC2L105030S	-	10,5	10,5	87	-	-	133	-	2



Other dimensions on request / Andere Abmessungen auf Anfrage

Dimensions in mm / Maße in mm

Solid carbide drill; SCT norm; long length; uncoated

VHM Bohrer; SCT Norm; lange Ausführung; unbeschichtet

Workpiece material groups and cutting speed / Werkstoffgruppen und Schnittgeschwindigkeiten

Material Material	Tensile strength Zugfestigkeit Rm [N/mm ²]	Hardness Härte [HB/HRC]	Cutting speed Vc [m/min] Schnittgeschwindigkeiten		
			min	opt	max
P1 Plain carbon steel / Unlegierter Stahl	< 600	< 230	60	70	80
P2 Alloy Steel / Legierter Stahl	< 1200	< 350	50	60	70
P3 High alloy steel and tool steel / Hochlegierter Stahl und Werkzeugstahl	< 1400	< 380	-	-	-
M1 Aust. and Ferr. Stainless steel / Aust. und Ferr. rostfreie Stähle	< 680	< 220	20	25	30
M2 Mart. Stainless steel / Mart. rostfreie Stähle	< 820	< 240	20	25	30
K1 Grey cast iron / Grauguß	-	< 280	70	80	90
K2 Ductile cast iron / Sphäroguß	-	< 320	50	60	70
N1 Non-ferrous alloys / Nichteisenmetalle	< 250	< 110	120	160	200
N2 Aluminium alloys / Aluminiumlegierungen	< 530	< 130	170	200	230
S1 High temperature alloys Fe, Ni and Co based / Warmfeste Leg. Fe, Ni und Co	< 3300	< 350	10	15	20
S2 Titanium alloys; Alpha and Beta / Titan Legierungen Alpha und Beta	< 2100	< 400	10	15	20
H1 Hardened steel / Gehärtete Stähle	-	< 54 HRC	-	-	-
H2 Hardened steel / Gehärtete Stähle	-	52-60 HRC	-	-	-
H3 Hardened steel / Gehärtete Stähle	-	> 58 HRC	-	-	-
G1 Graphite / Graphit	-	-	-	-	-

Cutting conditions / Zerspanungswerte

Material Material	f Feed per revolution [mm] / Vorschub pro Umdrehung [mm]										
	Ø 0 - 2	Ø 2 - 2,5	Ø 2,5 - 3	Ø 3 - 4	Ø 4 - 5	Ø 5 - 6	Ø 6 - 8	Ø 8 - 10	Ø 10 - 12	Ø 12 - 16	Ø 16 - 20
P1	0,080	0,100	0,125	0,160	0,160	0,200	0,250	0,315	0,315	0,400	0,500
P2	0,063	0,080	0,100	0,125	0,125	0,160	0,200	0,250	0,250	0,315	0,400
P3	0,050	0,063	0,080	0,100	0,100	0,125	0,160	0,200	0,200	0,250	0,315
M1	0,040	0,050	0,063	0,080	0,080	0,100	0,125	0,160	0,160	0,200	0,250
M2	0,032	0,040	0,050	0,063	0,063	0,080	0,100	0,125	0,125	0,160	0,200
K1	0,125	0,160	0,160	0,200	0,250	0,315	0,315	0,400	0,500	0,630	0,630
K2	0,100	0,125	0,160	0,200	0,200	0,250	0,315	0,400	0,400	0,500	0,630
N1	0,100	0,125	0,160	0,200	0,200	0,250	0,315	0,400	0,400	0,500	0,630
N2	0,125	0,160	0,160	0,200	0,250	0,315	0,315	0,400	0,500	0,630	0,630
S1	0,040	0,050	0,063	0,080	0,080	0,100	0,125	0,160	0,160	0,200	0,250
S2	0,032	0,040	0,050	0,063	0,063	0,080	0,100	0,125	0,125	0,160	0,200
H1	0,032	0,040	0,050	0,063	0,063	0,080	0,100	0,125	0,125	0,160	0,200
H2	0,025	0,032	0,040	0,050	0,050	0,063	0,080	0,100	0,100	0,125	0,160
H3	-	-	-	-	-	-	-	-	-	-	-
G1	-	-	-	-	-	-	-	-	-	-	-

Solid carbide drill; SCT norm; long length; uncoated
 VHM Bohrer; SCT Norm; lange Ausführung; unbeschichtet

Specifications / Spezifikationen



DIN 6535 HA	DIN 6535 HE	Dc	Ds	Ls	Ln	Dn	Lt	r	z
FLDC2L110030S	-	11,0	11,0	94	-	-	142	-	2
FLDC2L115030S	-	11,5	11,5	94	-	-	142	-	2
FLDC2L120030S	-	12,0	12,0	101	-	-	151	-	2



Other dimensions on request / Andere Abmessungen auf Anfrage

Dimensions in mm / Maße in mm

Solid carbide NC spot drill 90°; SCT norm; long length; uncoated
VHM NC Anbohrer 90°; SCT Norm; lange Ausführung; unbeschichtet

Workpiece material groups and cutting speed / Werkstoffgruppen und Schnittgeschwindigkeiten

Material Material	Tensile strength Zugfestigkeit Rm [N/mm ²]	Hardness Härte [HB/HRC]	Cutting speed Vc [m/min] Schnittgeschwindigkeiten		
			min	opt	max
P1 Plain carbon steel / Unlegierter Stahl	< 600	< 230	60	70	80
P2 Alloy Steel / Legierter Stahl	< 1200	< 350	50	60	70
P3 High alloy steel and tool steel / Hochlegierter Stahl und Werkzeugstahl	< 1400	< 380	-	-	-
M1 Aust. and Ferr. Stainless steel / Aust. und Ferr. rostfreie Stähle	< 680	< 220	20	25	30
M2 Mart. Stainless steel / Mart. rostfreie Stähle	< 820	< 240	20	25	30
K1 Grey cast iron / Grauguß	-	< 280	70	80	90
K2 Ductile cast iron / Sphäroguß	-	< 320	50	60	70
N1 Non-ferrous alloys / Nichteisenmetalle	< 250	< 110	120	160	200
N2 Aluminium alloys / Aluminiumlegierungen	< 530	< 130	170	200	230
S1 High temperature alloys Fe, Ni and Co based / Warmfeste Leg. Fe, Ni und Co	< 3300	< 350	10	15	20
S2 Titanium alloys; Alpha and Beta / Titan Legierungen Alpha und Beta	< 2100	< 400	10	15	20
H1 Hardened steel / Gehärtete Stähle	-	< 54 HRC	-	-	-
H2 Hardened steel / Gehärtete Stähle	-	52-60 HRC	-	-	-
H3 Hardened steel / Gehärtete Stähle	-	> 58 HRC	-	-	-
G1 Graphite / Graphit	-	-	-	-	-

Cutting conditions / Zerspanungswerte

Material Material	f Feed per revolution [mm] / Vorschub pro Umdrehung [mm]										
	Ø 0 - 2	Ø 2 - 2,5	Ø 2,5 - 3	Ø 3 - 4	Ø 4 - 5	Ø 5 - 6	Ø 6 - 8	Ø 8 - 10	Ø 10 - 12	Ø 12 - 16	Ø 16 - 20
P1	0,080	0,100	0,125	0,160	0,160	0,200	0,250	0,315	0,315	0,400	0,500
P2	0,063	0,080	0,100	0,125	0,125	0,160	0,200	0,250	0,250	0,315	0,400
P3	0,050	0,063	0,080	0,100	0,100	0,125	0,160	0,200	0,200	0,250	0,315
M1	0,040	0,050	0,063	0,080	0,080	0,100	0,125	0,160	0,160	0,200	0,250
M2	0,032	0,040	0,050	0,063	0,063	0,080	0,100	0,125	0,125	0,160	0,200
K1	0,125	0,160	0,160	0,200	0,250	0,315	0,315	0,400	0,500	0,630	0,630
K2	0,100	0,125	0,160	0,200	0,200	0,250	0,315	0,400	0,400	0,500	0,630
N1	0,100	0,125	0,160	0,200	0,200	0,250	0,315	0,400	0,400	0,500	0,630
N2	0,125	0,160	0,160	0,200	0,250	0,315	0,315	0,400	0,500	0,630	0,630
S1	0,040	0,050	0,063	0,080	0,080	0,100	0,125	0,160	0,160	0,200	0,250
S2	0,032	0,040	0,050	0,063	0,063	0,080	0,100	0,125	0,125	0,160	0,200
H1	0,032	0,040	0,050	0,063	0,063	0,080	0,100	0,125	0,125	0,160	0,200
H2	0,025	0,032	0,040	0,050	0,050	0,063	0,080	0,100	0,100	0,125	0,160
H3	-	-	-	-	-	-	-	-	-	-	-
G1	-	-	-	-	-	-	-	-	-	-	-

Solid carbide NC spot drill 90°; SCT norm; long length; uncoated
 VHM NC Anbohrer 90°; SCT Norm; lange Ausführung; unbeschichtet

Specifications / Spezifikationen



DIN 6535 HA	DIN 6535 HE	Dc	Ds	Ls	Ln	Dn	Lt	r	z
FLDC2S0600A90	-	6,0	6	15	-	-	65	-	2
FLDC2S0800A90	-	8,0	8	20	-	-	80	-	2
FLDC2S1000A90	-	10,0	10	25	-	-	90	-	2
FLDC2S1200A90	-	12,0	12	30	-	-	100	-	2



Other dimensions on request / Andere Abmessungen auf Anfrage

Dimensions in mm / Maße in mm

Solid carbide NC spot drill 120°; SCT norm; long length; uncoated

VHM NC Anbohrer 120°; SCT Norm; lange Ausführung; unbeschichtet

Workpiece material groups and cutting speed / Werkstoffgruppen und Schnittgeschwindigkeiten

Material Material	Tensile strength Zugfestigkeit Rm [N/mm ²]	Hardness Härte [HB/HRC]	Cutting speed Vc [m/min] Schnittgeschwindigkeiten		
			min	opt	max
P1 Plain carbon steel / Unlegierter Stahl	< 600	< 230	60	70	80
P2 Alloy Steel / Legierter Stahl	< 1200	< 350	50	60	70
P3 High alloy steel and tool steel / Hochlegierter Stahl und Werkzeugstahl	< 1400	< 380	-	-	-
M1 Aust. and Ferr. Stainless steel / Aust. und Ferr. rostfreie Stähle	< 680	< 220	20	25	30
M2 Mart. Stainless steel / Mart. rostfreie Stähle	< 820	< 240	20	25	30
K1 Grey cast iron / Grauguß	-	< 280	70	80	90
K2 Ductile cast iron / Sphäroguß	-	< 320	50	60	70
N1 Non-ferrous alloys / Nichteisenmetalle	< 250	< 110	120	160	200
N2 Aluminium alloys / Aluminiumlegierungen	< 530	< 130	170	200	230
S1 High temperature alloys Fe, Ni and Co based / Warmfeste Leg. Fe, Ni und Co	< 3300	< 350	10	15	20
S2 Titanium alloys; Alpha and Beta / Titan Legierungen Alpha und Beta	< 2100	< 400	10	15	20
H1 Hardened steel / Gehärtete Stähle	-	< 54 HRC	-	-	-
H2 Hardened steel / Gehärtete Stähle	-	52-60 HRC	-	-	-
H3 Hardened steel / Gehärtete Stähle	-	> 58 HRC	-	-	-
G1 Graphite / Graphit	-	-	-	-	-

Cutting conditions / Zerspanungswerte

Material Material	f Feed per revolution [mm] / Vorschub pro Umdrehung [mm]										
	Ø 0 - 2	Ø 2 - 2,5	Ø 2,5 - 3	Ø 3 - 4	Ø 4 - 5	Ø 5 - 6	Ø 6 - 8	Ø 8 - 10	Ø 10 - 12	Ø 12 - 16	Ø 16 - 20
P1	0,080	0,100	0,125	0,160	0,160	0,200	0,250	0,315	0,315	0,400	0,500
P2	0,063	0,080	0,100	0,125	0,125	0,160	0,200	0,250	0,250	0,315	0,400
P3	0,050	0,063	0,080	0,100	0,100	0,125	0,160	0,200	0,200	0,250	0,315
M1	0,040	0,050	0,063	0,080	0,080	0,100	0,125	0,160	0,160	0,200	0,250
M2	0,032	0,040	0,050	0,063	0,063	0,080	0,100	0,125	0,125	0,160	0,200
K1	0,125	0,160	0,160	0,200	0,250	0,315	0,315	0,400	0,500	0,630	0,630
K2	0,100	0,125	0,160	0,200	0,200	0,250	0,315	0,400	0,400	0,500	0,630
N1	0,100	0,125	0,160	0,200	0,200	0,250	0,315	0,400	0,400	0,500	0,630
N2	0,125	0,160	0,160	0,200	0,250	0,315	0,315	0,400	0,500	0,630	0,630
S1	0,040	0,050	0,063	0,080	0,080	0,100	0,125	0,160	0,160	0,200	0,250
S2	0,032	0,040	0,050	0,063	0,063	0,080	0,100	0,125	0,125	0,160	0,200
H1	0,032	0,040	0,050	0,063	0,063	0,080	0,100	0,125	0,125	0,160	0,200
H2	0,025	0,032	0,040	0,050	0,050	0,063	0,080	0,100	0,100	0,125	0,160
H3	-	-	-	-	-	-	-	-	-	-	-
G1	-	-	-	-	-	-	-	-	-	-	-

Solid carbide NC spot drill 120°; SCT norm; long length; uncoated
 VHM NC Anbohrer 120°; SCT Norm; lange Ausführung; unbeschichtet

Specifications / Spezifikationen



DIN 6535 HA	DIN 6535 HE	Dc	Ds	Ls	Ln	Dn	Lt	r	z
FLDC2S0600A120	-	6,0	6	15	-	-	65	-	2
FLDC2S0800A120	-	8,0	8	20	-	-	80	-	2
FLDC2S1000A120	-	10,0	10	25	-	-	90	-	2
FLDC2S1200A120	-	12,0	12	30	-	-	100	-	2



Other dimensions on request / Andere Abmessungen auf Anfrage

Dimensions in mm / Maße in mm



FLEXLINE
SOLID CARBIDE DRILLS[®]



Improving Quality Through Innovation

Product of Holland

UK D



- ▶ Universal drills / Universalbohrer
- ▶ 3xD, 5xD, 8xD and 12xD / 3xD, 5xD, 8xD und 12xD
- ▶ DIN standard and SCT norm / DIN Norm und SCT Werksnorm
- ▶ Internal coolant / Innenkühlung
- ▶ TiAlN coated / TiAlN beschichtet



Improving Quality Through Innovation

Product of Holland



Table of contents Inhaltsverzeichnis

Solid carbide drill; 3xD; DIN6537K; without internal coolant holes; TiAlN coated
VHM Bohrer; 3xD; DIN6537K; ohne Innenkühlung; TiAlN beschichtet

4 - 9



Solid carbide drill; 3xD; DIN6537K; with internal coolant holes; TiAlN coated
VHM Bohrer; 3xD; DIN6537K; mit Innenkühlung; TiAlN beschichtet

10 - 15



Solid carbide drill; 5xD; DIN6537L; with internal coolant holes; TiAlN coated
VHM Bohrer; 5xD; DIN6537L; mit Innenkühlung; TiAlN beschichtet

16 - 21



Solid carbide drill; 8xD; SCT norm; with internal coolant holes; TiAlN coated
VHM Bohrer; 8xD; SCT Norm; mit Innenkühlung; TiAlN beschichtet

22 - 27



Solid carbide drill; 12xD; SCT norm; with internal coolant holes; TiAlN coated
VHM Bohrer; 12xD; SCT Norm; mit Innenkühlung; TiAlN beschichtet

28 - 33



Solid carbide drill; 3xD; DIN6537K; without internal coolant holes; TiAlN coated

VHM Bohrer; 3xD; DIN6537K; ohne Innenkühlung; TiAlN beschichtet

Workpiece material groups and cutting speed / Werkstoffgruppen und Schnittgeschwindigkeiten

Material Material	Tensile strength Zugfestigkeit Rm [N/mm ²]	Hardness Härte [HB/HRC]	Cutting speed Vc [m/min] Schnittgeschwindigkeiten		
			min	opt	max
P1 Plain carbon steel / Unlegierter Stahl	< 600	< 230	100	110	120
P2 Alloy Steel / Legierter Stahl	< 1200	< 350	80	90	100
P3 High alloy steel and tool steel / Hochlegierter Stahl und Werkzeugstahl	< 1400	< 380	60	70	80
M1 Aust. and Ferr. Stainless steel / Aust. und Ferr. rostfreie Stähle	< 680	< 220	40	50	60
M2 Mart. Stainless steel / Mart. rostfreie Stähle	< 820	< 240	40	50	60
K1 Grey cast iron / Grauguß	-	< 280	180	200	220
K2 Ductile cast iron / Sphäroguß	-	< 320	140	160	180
N1 Non-ferrous alloys / Nichteisenmetalle	< 250	< 110	-	-	-
N2 Aluminium alloys / Aluminiumlegierungen	< 530	< 130	-	-	-
S1 High temperature alloys Fe, Ni and Co based / Warmfeste Leg. Fe, Ni und Co	< 3300	< 350	20	30	40
S2 Titanium alloys; Alpha and Beta / Titan Legierungen Alpha und Beta	< 2100	< 400	30	40	50
H1 Hardened steel / Gehärtete Stähle	-	< 54 HRC	30	40	50
H2 Hardened steel / Gehärtete Stähle	-	52-60 HRC	20	25	30
H3 Hardened steel / Gehärtete Stähle	-	> 58 HRC	-	-	-
G1 Graphite / Graphit	-	-	-	-	-

Cutting conditions / Zerspanungswerte

Material Material	f Feed per revolution [mm] / Vorschub pro Umdrehung [mm]										
	Ø 0 - 2	Ø 2 - 2,5	Ø 2,5 - 3	Ø 3 - 4	Ø 4 - 5	Ø 5 - 6	Ø 6 - 8	Ø 8 - 10	Ø 10 - 12	Ø 12 - 16	Ø 16 - 20
P1	0,080	0,100	0,125	0,160	0,160	0,200	0,250	0,315	0,315	0,400	0,500
P2	0,063	0,080	0,100	0,125	0,125	0,160	0,200	0,250	0,250	0,315	0,400
P3	0,050	0,063	0,080	0,100	0,100	0,125	0,160	0,200	0,200	0,250	0,315
M1	0,040	0,050	0,063	0,080	0,080	0,100	0,125	0,160	0,160	0,200	0,250
M2	0,032	0,040	0,050	0,063	0,063	0,080	0,100	0,125	0,125	0,160	0,200
K1	0,125	0,160	0,160	0,200	0,250	0,315	0,315	0,400	0,500	0,630	0,630
K2	0,100	0,125	0,160	0,200	0,200	0,250	0,315	0,400	0,400	0,500	0,630
N1	0,100	0,125	0,160	0,200	0,200	0,250	0,315	0,400	0,400	0,500	0,630
N2	0,125	0,160	0,160	0,200	0,250	0,315	0,315	0,400	0,500	0,630	0,630
S1	0,040	0,050	0,063	0,080	0,080	0,100	0,125	0,160	0,160	0,200	0,250
S2	0,032	0,040	0,050	0,063	0,063	0,080	0,100	0,125	0,125	0,160	0,200
H1	0,032	0,040	0,050	0,063	0,063	0,080	0,100	0,125	0,125	0,160	0,200
H2	0,025	0,032	0,040	0,050	0,050	0,063	0,080	0,100	0,100	0,125	0,160
H3	-	-	-	-	-	-	-	-	-	-	-
G1	-	-	-	-	-	-	-	-	-	-	-

Solid carbide drill; 3xD; DIN6537K; without internal coolant holes; TiAlN coated
 VHM Bohrer; 3xD; DIN6537K; ohne Innenkühlung; TiAlN beschichtet

Specifications / Spezifikationen

DIN 6535 HA	DIN 6535 HE	Dc	Ds	Ls	Ln	Dn	Lt	r	z
BLDC203D030030S	BLDE203D030030S	3,0	6	20	-	-	62	-	2
BLDC203D031030S	BLDE203D031030S	3,1	6	20	-	-	62	-	2
BLDC203D032030S	BLDE203D032030S	3,2	6	20	-	-	62	-	2
BLDC203D033030S	BLDE203D033030S	3,3	6	20	-	-	62	-	2
BLDC203D034030S	BLDE203D034030S	3,4	6	20	-	-	62	-	2
BLDC203D035030S	BLDE203D035030S	3,5	6	20	-	-	62	-	2
BLDC203D036030S	BLDE203D036030S	3,6	6	20	-	-	62	-	2
BLDC203D037030S	BLDE203D037030S	3,7	6	20	-	-	62	-	2
BLDC203D038030S	BLDE203D038030S	3,8	6	24	-	-	66	-	2
BLDC203D039030S	BLDE203D039030S	3,9	6	24	-	-	66	-	2
BLDC203D040030S	BLDE203D040030S	4,0	6	24	-	-	66	-	2
BLDC203D041030S	BLDE203D041030S	4,1	6	24	-	-	66	-	2
BLDC203D042030S	BLDE203D042030S	4,2	6	24	-	-	66	-	2
BLDC203D043030S	BLDE203D043030S	4,3	6	24	-	-	66	-	2
BLDC203D044030S	BLDE203D044030S	4,4	6	24	-	-	66	-	2
BLDC203D045030S	BLDE203D045030S	4,5	6	24	-	-	66	-	2
BLDC203D046030S	BLDE203D046030S	4,6	6	24	-	-	66	-	2
BLDC203D047030S	BLDE203D047030S	4,7	6	24	-	-	66	-	2
BLDC203D048030S	BLDE203D048030S	4,8	6	28	-	-	66	-	2
BLDC203D049030S	BLDE203D049030S	4,9	6	28	-	-	66	-	2
BLDC203D050030S	BLDE203D050030S	5,0	6	28	-	-	66	-	2
BLDC203D051030S	BLDE203D051030S	5,1	6	28	-	-	66	-	2
BLDC203D052030S	BLDE203D052030S	5,2	6	28	-	-	66	-	2
BLDC203D053030S	BLDE203D053030S	5,3	6	28	-	-	66	-	2
BLDC203D054030S	BLDE203D054030S	5,4	6	28	-	-	66	-	2
BLDC203D055030S	BLDE203D055030S	5,5	6	28	-	-	66	-	2
BLDC203D056030S	BLDE203D056030S	5,6	6	28	-	-	66	-	2
BLDC203D057030S	BLDE203D057030S	5,7	6	28	-	-	66	-	2
BLDC203D058030S	BLDE203D058030S	5,8	6	28	-	-	66	-	2
BLDC203D059030S	BLDE203D059030S	5,9	6	28	-	-	66	-	2
BLDC203D060030S	BLDE203D060030S	6,0	6	28	-	-	66	-	2
BLDC203D061030S	BLDE203D061030S	6,1	8	34	-	-	79	-	2
BLDC203D062030S	BLDE203D062030S	6,2	8	34	-	-	79	-	2
BLDC203D063030S	BLDE203D063030S	6,3	8	34	-	-	79	-	2
BLDC203D064030S	BLDE203D064030S	6,4	8	34	-	-	79	-	2
BLDC203D065030S	BLDE203D065030S	6,5	8	34	-	-	79	-	2
BLDC203D066030S	BLDE203D066030S	6,6	8	34	-	-	79	-	2
BLDC203D067030S	BLDE203D067030S	6,7	8	34	-	-	79	-	2
BLDC203D068030S	BLDE203D068030S	6,8	8	34	-	-	79	-	2
BLDC203D069030S	BLDE203D069030S	6,9	8	34	-	-	79	-	2
BLDC203D070030S	BLDE203D070030S	7,0	8	34	-	-	79	-	2
BLDC203D071030S	BLDE203D071030S	7,1	8	41	-	-	79	-	2
BLDC203D072030S	BLDE203D072030S	7,2	8	41	-	-	79	-	2
BLDC203D073030S	BLDE203D073030S	7,3	8	41	-	-	79	-	2



Other dimensions on request / Andere Abmessungen auf Anfrage

Dimensions in mm / Maße in mm

Solid carbide drill; 3xD; DIN6537K; without internal coolant holes; TiAlN coated

VHM Bohrer; 3xD; DIN6537K; ohne Innenkühlung; TiAlN beschichtet

Workpiece material groups and cutting speed / Werkstoffgruppen und Schnittgeschwindigkeiten

Material Material	Tensile strength Zugfestigkeit Rm [N/mm ²]	Hardness Härte [HB/HRC]	Cutting speed Vc [m/min] Schnittgeschwindigkeiten		
			min	opt	max
P1 Plain carbon steel / Unlegierter Stahl	< 600	< 230	100	110	120
P2 Alloy Steel / Legierter Stahl	< 1200	< 350	80	90	100
P3 High alloy steel and tool steel / Hochlegierter Stahl und Werkzeugstahl	< 1400	< 380	60	70	80
M1 Aust. and Ferr. Stainless steel / Aust. und Ferr. rostfreie Stähle	< 680	< 220	40	50	60
M2 Mart. Stainless steel / Mart. rostfreie Stähle	< 820	< 240	40	50	60
K1 Grey cast iron / Grauguß	-	< 280	180	200	220
K2 Ductile cast iron / Sphäroguß	-	< 320	140	160	180
N1 Non-ferrous alloys / Nichteisenmetalle	< 250	< 110	-	-	-
N2 Aluminium alloys / Aluminiumlegierungen	< 530	< 130	-	-	-
S1 High temperature alloys Fe, Ni and Co based / Warmfeste Leg. Fe, Ni und Co	< 3300	< 350	20	30	40
S2 Titanium alloys; Alpha and Beta / Titan Legierungen Alpha und Beta	< 2100	< 400	30	40	50
H1 Hardened steel / Gehärtete Stähle	-	< 54 HRC	30	40	50
H2 Hardened steel / Gehärtete Stähle	-	52-60 HRC	20	25	30
H3 Hardened steel / Gehärtete Stähle	-	> 58 HRC	-	-	-
G1 Graphite / Graphit	-	-	-	-	-

Cutting conditions / Zerspanungswerte

Material Material	f Feed per revolution [mm] / Vorschub pro Umdrehung [mm]										
	Ø 0 - 2	Ø 2 - 2,5	Ø 2,5 - 3	Ø 3 - 4	Ø 4 - 5	Ø 5 - 6	Ø 6 - 8	Ø 8 - 10	Ø 10 - 12	Ø 12 - 16	Ø 16 - 20
P1	0,080	0,100	0,125	0,160	0,160	0,200	0,250	0,315	0,315	0,400	0,500
P2	0,063	0,080	0,100	0,125	0,125	0,160	0,200	0,250	0,250	0,315	0,400
P3	0,050	0,063	0,080	0,100	0,100	0,125	0,160	0,200	0,200	0,250	0,315
M1	0,040	0,050	0,063	0,080	0,080	0,100	0,125	0,160	0,160	0,200	0,250
M2	0,032	0,040	0,050	0,063	0,063	0,080	0,100	0,125	0,125	0,160	0,200
K1	0,125	0,160	0,160	0,200	0,250	0,315	0,315	0,400	0,500	0,630	0,630
K2	0,100	0,125	0,160	0,200	0,200	0,250	0,315	0,400	0,400	0,500	0,630
N1	0,100	0,125	0,160	0,200	0,200	0,250	0,315	0,400	0,400	0,500	0,630
N2	0,125	0,160	0,160	0,200	0,250	0,315	0,315	0,400	0,500	0,630	0,630
S1	0,040	0,050	0,063	0,080	0,080	0,100	0,125	0,160	0,160	0,200	0,250
S2	0,032	0,040	0,050	0,063	0,063	0,080	0,100	0,125	0,125	0,160	0,200
H1	0,032	0,040	0,050	0,063	0,063	0,080	0,100	0,125	0,125	0,160	0,200
H2	0,025	0,032	0,040	0,050	0,050	0,063	0,080	0,100	0,100	0,125	0,160
H3	-	-	-	-	-	-	-	-	-	-	-
G1	-	-	-	-	-	-	-	-	-	-	-

Solid carbide drill; 3xD; DIN6537K; without internal coolant holes; TiAlN coated
 VHM Bohrer; 3xD; DIN6537K; ohne Innenkühlung; TiAlN beschichtet

Specifications / Spezifikationen

DIN 6535 HA	DIN 6535 HE	Dc	Ds	Ls	Ln	Dn	Lt	r	z
BLDC203D074030S	BLDE203D074030S	7,4	8	41	-	-	79	-	2
BLDC203D075030S	BLDE203D075030S	7,5	8	41	-	-	79	-	2
BLDC203D076030S	BLDE203D076030S	7,6	8	41	-	-	79	-	2
BLDC203D077030S	BLDE203D077030S	7,7	8	41	-	-	79	-	2
BLDC203D078030S	BLDE203D078030S	7,8	8	41	-	-	79	-	2
BLDC203D079030S	BLDE203D079030S	7,9	8	41	-	-	79	-	2
BLDC203D080030S	BLDE203D080030S	8,0	8	41	-	-	79	-	2
BLDC203D081030S	BLDE203D081030S	8,1	10	47	-	-	89	-	2
BLDC203D082030S	BLDE203D082030S	8,2	10	47	-	-	89	-	2
BLDC203D083030S	BLDE203D083030S	8,3	10	47	-	-	89	-	2
BLDC203D084030S	BLDE203D084030S	8,4	10	47	-	-	89	-	2
BLDC203D085030S	BLDE203D085030S	8,5	10	47	-	-	89	-	2
BLDC203D086030S	BLDE203D086030S	8,6	10	47	-	-	89	-	2
BLDC203D087030S	BLDE203D087030S	8,7	10	47	-	-	89	-	2
BLDC203D088030S	BLDE203D088030S	8,8	10	47	-	-	89	-	2
BLDC203D089030S	BLDE203D089030S	8,9	10	47	-	-	89	-	2
BLDC203D090030S	BLDE203D090030S	9,0	10	47	-	-	89	-	2
BLDC203D091030S	BLDE203D091030S	9,1	10	47	-	-	89	-	2
BLDC203D092030S	BLDE203D092030S	9,2	10	47	-	-	89	-	2
BLDC203D093030S	BLDE203D093030S	9,3	10	47	-	-	89	-	2
BLDC203D094030S	BLDE203D094030S	9,4	10	47	-	-	89	-	2
BLDC203D095030S	BLDE203D095030S	9,5	10	47	-	-	89	-	2
BLDC203D096030S	BLDE203D096030S	9,6	10	47	-	-	89	-	2
BLDC203D097030S	BLDE203D097030S	9,7	10	47	-	-	89	-	2
BLDC203D098030S	BLDE203D098030S	9,8	10	47	-	-	89	-	2
BLDC203D099030S	BLDE203D099030S	9,9	10	47	-	-	89	-	2
BLDC203D100030S	BLDE203D100030S	10,0	10	47	-	-	89	-	2
BLDC203D101030S	BLDE203D101030S	10,1	12	55	-	-	102	-	2
BLDC203D102030S	BLDE203D102030S	10,2	12	55	-	-	102	-	2
BLDC203D103030S	BLDE203D103030S	10,3	12	55	-	-	102	-	2
BLDC203D104030S	BLDE203D104030S	10,4	12	55	-	-	102	-	2
BLDC203D105030S	BLDE203D105030S	10,5	12	55	-	-	102	-	2
BLDC203D106030S	BLDE203D106030S	10,6	12	55	-	-	102	-	2
BLDC203D107030S	BLDE203D107030S	10,7	12	55	-	-	102	-	2
BLDC203D108030S	BLDE203D108030S	10,8	12	55	-	-	102	-	2
BLDC203D109030S	BLDE203D109030S	10,9	12	55	-	-	102	-	2
BLDC203D110030S	BLDE203D110030S	11,0	12	55	-	-	102	-	2
BLDC203D111030S	BLDE203D111030S	11,1	12	55	-	-	102	-	2
BLDC203D112030S	BLDE203D112030S	11,2	12	55	-	-	102	-	2
BLDC203D113030S	BLDE203D113030S	11,3	12	55	-	-	102	-	2
BLDC203D114030S	BLDE203D114030S	11,4	12	55	-	-	102	-	2
BLDC203D115030S	BLDE203D115030S	11,5	12	55	-	-	102	-	2
BLDC203D116030S	BLDE203D116030S	11,6	12	55	-	-	102	-	2
BLDC203D117030S	BLDE203D117030S	11,7	12	55	-	-	102	-	2



Other dimensions on request / Andere Abmessungen auf Anfrage

Dimensions in mm / Maße in mm

Solid carbide drill; 3xD; DIN6537K; without internal coolant holes; TiAlN coated

VHM Bohrer; 3xD; DIN6537K; ohne Innenkühlung; TiAlN beschichtet

Workpiece material groups and cutting speed / Werkstoffgruppen und Schnittgeschwindigkeiten

Material Material	Tensile strength Zugfestigkeit Rm [N/mm ²]	Hardness Härte [HB/HRC]	Cutting speed Vc [m/min] Schnittgeschwindigkeiten		
			min	opt	max
P1 Plain carbon steel / Unlegierter Stahl	< 600	< 230	100	110	120
P2 Alloy Steel / Legierter Stahl	< 1200	< 350	80	90	100
P3 High alloy steel and tool steel / Hochlegierter Stahl und Werkzeugstahl	< 1400	< 380	60	70	80
M1 Aust. and Ferr. Stainless steel / Aust. und Ferr. rostfreie Stähle	< 680	< 220	40	50	60
M2 Mart. Stainless steel / Mart. rostfreie Stähle	< 820	< 240	40	50	60
K1 Grey cast iron / Grauguß	-	< 280	180	200	220
K2 Ductile cast iron / Sphäroguß	-	< 320	140	160	180
N1 Non-ferrous alloys / Nichteisenmetalle	< 250	< 110	-	-	-
N2 Aluminium alloys / Aluminiumlegierungen	< 530	< 130	-	-	-
S1 High temperature alloys Fe, Ni and Co based / Warmfeste Leg. Fe, Ni und Co	< 3300	< 350	20	30	40
S2 Titanium alloys; Alpha and Beta / Titan Legierungen Alpha und Beta	< 2100	< 400	30	40	50
H1 Hardened steel / Gehärtete Stähle	-	< 54 HRC	30	40	50
H2 Hardened steel / Gehärtete Stähle	-	52-60 HRC	20	25	30
H3 Hardened steel / Gehärtete Stähle	-	> 58 HRC	-	-	-
G1 Graphite / Graphit	-	-	-	-	-

Cutting conditions / Zerspanungswerte

Material Material	f Feed per revolution [mm] / Vorschub pro Umdrehung [mm]										
	Ø 0 - 2	Ø 2 - 2,5	Ø 2,5 - 3	Ø 3 - 4	Ø 4 - 5	Ø 5 - 6	Ø 6 - 8	Ø 8 - 10	Ø 10 - 12	Ø 12 - 16	Ø 16 - 20
P1	0,080	0,100	0,125	0,160	0,160	0,200	0,250	0,315	0,315	0,400	0,500
P2	0,063	0,080	0,100	0,125	0,125	0,160	0,200	0,250	0,250	0,315	0,400
P3	0,050	0,063	0,080	0,100	0,100	0,125	0,160	0,200	0,200	0,250	0,315
M1	0,040	0,050	0,063	0,080	0,080	0,100	0,125	0,160	0,160	0,200	0,250
M2	0,032	0,040	0,050	0,063	0,063	0,080	0,100	0,125	0,125	0,160	0,200
K1	0,125	0,160	0,160	0,200	0,250	0,315	0,315	0,400	0,500	0,630	0,630
K2	0,100	0,125	0,160	0,200	0,200	0,250	0,315	0,400	0,400	0,500	0,630
N1	0,100	0,125	0,160	0,200	0,200	0,250	0,315	0,400	0,400	0,500	0,630
N2	0,125	0,160	0,160	0,200	0,250	0,315	0,315	0,400	0,500	0,630	0,630
S1	0,040	0,050	0,063	0,080	0,080	0,100	0,125	0,160	0,160	0,200	0,250
S2	0,032	0,040	0,050	0,063	0,063	0,080	0,100	0,125	0,125	0,160	0,200
H1	0,032	0,040	0,050	0,063	0,063	0,080	0,100	0,125	0,125	0,160	0,200
H2	0,025	0,032	0,040	0,050	0,050	0,063	0,080	0,100	0,100	0,125	0,160
H3	-	-	-	-	-	-	-	-	-	-	-
G1	-	-	-	-	-	-	-	-	-	-	-

Solid carbide drill; 3xD; DIN6537K; without internal coolant holes; TiAlN coated
 VHM Bohrer; 3xD; DIN6537K; ohne Innenkühlung; TiAlN beschichtet

Specifications / Spezifikationen

DIN 6535 HA	DIN 6535 HE	Dc	Ds	Ls	Ln	Dn	Lt	r	z
BLDC203D118030S	BLDE203D118030S	11,8	12	55	-	-	102	-	2
BLDC203D119030S	BLDE203D119030S	11,9	12	55	-	-	102	-	2
BLDC203D120030S	BLDE203D120030S	12,0	12	55	-	-	102	-	2
BLDC203D125030S	BLDE203D125030S	12,5	14	60	-	-	107	-	2
BLDC203D128030S	BLDE203D128030S	12,8	14	60	-	-	107	-	2
BLDC203D130030S	BLDE203D130030S	13,0	14	60	-	-	107	-	2
BLDC203D135030S	BLDE203D135030S	13,5	14	60	-	-	107	-	2
BLDC203D138030S	BLDE203D138030S	13,8	14	60	-	-	107	-	2
BLDC203D140030S	BLDE203D140030S	14,0	14	60	-	-	107	-	2
BLDC203D145030S	BLDE203D145030S	14,5	16	65	-	-	115	-	2
BLDC203D148030S	BLDE203D148030S	14,8	16	65	-	-	115	-	2
BLDC203D150030S	BLDE203D150030S	15,0	16	65	-	-	115	-	2
BLDC203D158030S	BLDE203D158030S	15,8	16	65	-	-	115	-	2
BLDC203D160030S	BLDE203D160030S	16,0	16	65	-	-	115	-	2
BLDC203D165030S	BLDE203D165030S	16,5	18	73	-	-	123	-	2
BLDC203D170030S	BLDE203D170030S	17,0	18	73	-	-	123	-	2
BLDC203D175030S	BLDE203D175030S	17,5	18	73	-	-	123	-	2
BLDC203D180030S	BLDE203D180030S	18,0	18	73	-	-	123	-	2
BLDC203D185030S	BLDE203D185030S	18,5	20	79	-	-	131	-	2
BLDC203D190030S	BLDE203D190030S	19,0	20	79	-	-	131	-	2
BLDC203D195030S	BLDE203D195030S	19,5	20	79	-	-	131	-	2
BLDC203D200030S	BLDE203D200030S	20,0	20	79	-	-	131	-	2



Solid carbide drill; 3xD; DIN6537K; with internal coolant holes; TiAlN coated

VHM Bohrer; 3xD; DIN6537K; mit Innenkühlung; TiAlN beschichtet

Workpiece material groups and cutting speed / Werkstoffgruppen und Schnittgeschwindigkeiten

Material Material	Tensile strength Zugfestigkeit Rm [N/mm ²]	Hardness Härte [HB/HRC]	Cutting speed Vc [m/min] Schnittgeschwindigkeiten		
			min	opt	max
P1 Plain carbon steel / Unlegierter Stahl	< 600	< 230	100	110	120
P2 Alloy Steel / Legierter Stahl	< 1200	< 350	80	90	100
P3 High alloy steel and tool steel / Hochlegierter Stahl und Werkzeugstahl	< 1400	< 380	60	70	80
M1 Aust. and Ferr. Stainless steel / Aust. und Ferr. rostfreie Stähle	< 680	< 220	40	50	60
M2 Mart. Stainless steel / Mart. rostfreie Stähle	< 820	< 240	40	50	60
K1 Grey cast iron / Grauguß	-	< 280	180	200	220
K2 Ductile cast iron / Sphäroguß	-	< 320	140	160	180
N1 Non-ferrous alloys / Nichteisenmetalle	< 250	< 110	-	-	-
N2 Aluminium alloys / Aluminiumlegierungen	< 530	< 130	-	-	-
S1 High temperature alloys Fe, Ni and Co based / Warmfeste Leg. Fe, Ni und Co	< 3300	< 350	20	30	40
S2 Titanium alloys; Alpha and Beta / Titan Legierungen Alpha und Beta	< 2100	< 400	30	40	50
H1 Hardened steel / Gehärtete Stähle	-	< 54 HRC	30	40	50
H2 Hardened steel / Gehärtete Stähle	-	52-60 HRC	20	25	30
H3 Hardened steel / Gehärtete Stähle	-	> 58 HRC	-	-	-
G1 Graphite / Graphit	-	-	-	-	-

Cutting conditions / Zerspanungswerte

Material Material	f Feed per revolution [mm] / Vorschub pro Umdrehung [mm]										
	Ø 0 - 2	Ø 2 - 2,5	Ø 2,5 - 3	Ø 3 - 4	Ø 4 - 5	Ø 5 - 6	Ø 6 - 8	Ø 8 - 10	Ø 10 - 12	Ø 12 - 16	Ø 16 - 20
P1	0,080	0,100	0,125	0,160	0,160	0,200	0,250	0,315	0,315	0,400	0,500
P2	0,063	0,080	0,100	0,125	0,125	0,160	0,200	0,250	0,250	0,315	0,400
P3	0,050	0,063	0,080	0,100	0,100	0,125	0,160	0,200	0,200	0,250	0,315
M1	0,040	0,050	0,063	0,080	0,080	0,100	0,125	0,160	0,160	0,200	0,250
M2	0,032	0,040	0,050	0,063	0,063	0,080	0,100	0,125	0,125	0,160	0,200
K1	0,125	0,160	0,160	0,200	0,250	0,315	0,315	0,400	0,500	0,630	0,630
K2	0,100	0,125	0,160	0,200	0,200	0,250	0,315	0,400	0,400	0,500	0,630
N1	0,100	0,125	0,160	0,200	0,200	0,250	0,315	0,400	0,400	0,500	0,630
N2	0,125	0,160	0,160	0,200	0,250	0,315	0,315	0,400	0,500	0,630	0,630
S1	0,040	0,050	0,063	0,080	0,080	0,100	0,125	0,160	0,160	0,200	0,250
S2	0,032	0,040	0,050	0,063	0,063	0,080	0,100	0,125	0,125	0,160	0,200
H1	0,032	0,040	0,050	0,063	0,063	0,080	0,100	0,125	0,125	0,160	0,200
H2	0,025	0,032	0,040	0,050	0,050	0,063	0,080	0,100	0,100	0,125	0,160
H3	-	-	-	-	-	-	-	-	-	-	-
G1	-	-	-	-	-	-	-	-	-	-	-

Solid carbide drill; 3xD; DIN6537K; with internal coolant holes; TiAlN coated
 VHM Bohrer; 3xD; DIN6537K; mit Innenkühlung; TiAlN beschichtet

Specifications / Spezifikationen

DIN 6535 HA	DIN 6535 HE	Dc	Ds	Ls	Ln	Dn	Lt	r	z
BLDC203D030030SIK	BLDE203D030030SIK	3,0	6	20	-	-	62	-	2
BLDC203D031030SIK	BLDE203D031030SIK	3,1	6	20	-	-	62	-	2
BLDC203D032030SIK	BLDE203D032030SIK	3,2	6	20	-	-	62	-	2
BLDC203D033030SIK	BLDE203D033030SIK	3,3	6	20	-	-	62	-	2
BLDC203D034030SIK	BLDE203D034030SIK	3,4	6	20	-	-	62	-	2
BLDC203D035030SIK	BLDE203D035030SIK	3,5	6	20	-	-	62	-	2
BLDC203D036030SIK	BLDE203D036030SIK	3,6	6	20	-	-	62	-	2
BLDC203D037030SIK	BLDE203D037030SIK	3,7	6	20	-	-	62	-	2
BLDC203D038030SIK	BLDE203D038030SIK	3,8	6	24	-	-	66	-	2
BLDC203D039030SIK	BLDE203D039030SIK	3,9	6	24	-	-	66	-	2
BLDC203D040030SIK	BLDE203D040030SIK	4,0	6	24	-	-	66	-	2
BLDC203D041030SIK	BLDE203D041030SIK	4,1	6	24	-	-	66	-	2
BLDC203D042030SIK	BLDE203D042030SIK	4,2	6	24	-	-	66	-	2
BLDC203D043030SIK	BLDE203D043030SIK	4,3	6	24	-	-	66	-	2
BLDC203D044030SIK	BLDE203D044030SIK	4,4	6	24	-	-	66	-	2
BLDC203D045030SIK	BLDE203D045030SIK	4,5	6	24	-	-	66	-	2
BLDC203D046030SIK	BLDE203D046030SIK	4,6	6	24	-	-	66	-	2
BLDC203D047030SIK	BLDE203D047030SIK	4,7	6	24	-	-	66	-	2
BLDC203D048030SIK	BLDE203D048030SIK	4,8	6	28	-	-	66	-	2
BLDC203D049030SIK	BLDE203D049030SIK	4,9	6	28	-	-	66	-	2
BLDC203D050030SIK	BLDE203D050030SIK	5,0	6	28	-	-	66	-	2
BLDC203D051030SIK	BLDE203D051030SIK	5,1	6	28	-	-	66	-	2
BLDC203D052030SIK	BLDE203D052030SIK	5,2	6	28	-	-	66	-	2
BLDC203D053030SIK	BLDE203D053030SIK	5,3	6	28	-	-	66	-	2
BLDC203D054030SIK	BLDE203D054030SIK	5,4	6	28	-	-	66	-	2
BLDC203D055030SIK	BLDE203D055030SIK	5,5	6	28	-	-	66	-	2
BLDC203D056030SIK	BLDE203D056030SIK	5,6	6	28	-	-	66	-	2
BLDC203D057030SIK	BLDE203D057030SIK	5,7	6	28	-	-	66	-	2
BLDC203D058030SIK	BLDE203D058030SIK	5,8	6	28	-	-	66	-	2
BLDC203D059030SIK	BLDE203D059030SIK	5,9	6	28	-	-	66	-	2
BLDC203D060030SIK	BLDE203D060030SIK	6,0	6	28	-	-	66	-	2
BLDC203D061030SIK	BLDE203D061030SIK	6,1	8	34	-	-	79	-	2
BLDC203D062030SIK	BLDE203D062030SIK	6,2	8	34	-	-	79	-	2
BLDC203D063030SIK	BLDE203D063030SIK	6,3	8	34	-	-	79	-	2
BLDC203D064030SIK	BLDE203D064030SIK	6,4	8	34	-	-	79	-	2
BLDC203D065030SIK	BLDE203D065030SIK	6,5	8	34	-	-	79	-	2
BLDC203D066030SIK	BLDE203D066030SIK	6,6	8	34	-	-	79	-	2
BLDC203D067030SIK	BLDE203D067030SIK	6,7	8	34	-	-	79	-	2
BLDC203D068030SIK	BLDE203D068030SIK	6,8	8	34	-	-	79	-	2
BLDC203D069030SIK	BLDE203D069030SIK	6,9	8	34	-	-	79	-	2
BLDC203D070030SIK	BLDE203D070030SIK	7,0	8	34	-	-	79	-	2
BLDC203D071030SIK	BLDE203D071030SIK	7,1	8	41	-	-	79	-	2
BLDC203D072030SIK	BLDE203D072030SIK	7,2	8	41	-	-	79	-	2
BLDC203D073030SIK	BLDE203D073030SIK	7,3	8	41	-	-	79	-	2



Other dimensions on request / Andere Abmessungen auf Anfrage

Dimensions in mm / Maße in mm

Solid carbide drill; 3xD; DIN6537K; with internal coolant holes; TiAlN coated

VHM Bohrer; 3xD; DIN6537K; mit Innenkühlung; TiAlN beschichtet

Workpiece material groups and cutting speed / Werkstoffgruppen und Schnittgeschwindigkeiten

Material Material	Tensile strength Zugfestigkeit Rm [N/mm ²]	Hardness Härte [HB/HRC]	Cutting speed Vc [m/min] Schnittgeschwindigkeiten		
			min	opt	max
P1 Plain carbon steel / Unlegierter Stahl	< 600	< 230	100	110	120
P2 Alloy Steel / Legierter Stahl	< 1200	< 350	80	90	100
P3 High alloy steel and tool steel / Hochlegierter Stahl und Werkzeugstahl	< 1400	< 380	60	70	80
M1 Aust. and Ferr. Stainless steel / Aust. und Ferr. rostfreie Stähle	< 680	< 220	40	50	60
M2 Mart. Stainless steel / Mart. rostfreie Stähle	< 820	< 240	40	50	60
K1 Grey cast iron / Grauguß	-	< 280	180	200	220
K2 Ductile cast iron / Sphäroguß	-	< 320	140	160	180
N1 Non-ferrous alloys / Nichteisenmetalle	< 250	< 110	-	-	-
N2 Aluminium alloys / Aluminiumlegierungen	< 530	< 130	-	-	-
S1 High temperature alloys Fe, Ni and Co based / Warmfeste Leg. Fe, Ni und Co	< 3300	< 350	20	30	40
S2 Titanium alloys; Alpha and Beta / Titan Legierungen Alpha und Beta	< 2100	< 400	30	40	50
H1 Hardened steel / Gehärtete Stähle	-	< 54 HRC	30	40	50
H2 Hardened steel / Gehärtete Stähle	-	52-60 HRC	20	25	30
H3 Hardened steel / Gehärtete Stähle	-	> 58 HRC	-	-	-
G1 Graphite / Graphit	-	-	-	-	-

Cutting conditions / Zerspanungswerte

Material Material	f Feed per revolution [mm] / Vorschub pro Umdrehung [mm]										
	Ø 0 - 2	Ø 2 - 2,5	Ø 2,5 - 3	Ø 3 - 4	Ø 4 - 5	Ø 5 - 6	Ø 6 - 8	Ø 8 - 10	Ø 10 - 12	Ø 12 - 16	Ø 16 - 20
P1	0,080	0,100	0,125	0,160	0,160	0,200	0,250	0,315	0,315	0,400	0,500
P2	0,063	0,080	0,100	0,125	0,125	0,160	0,200	0,250	0,250	0,315	0,400
P3	0,050	0,063	0,080	0,100	0,100	0,125	0,160	0,200	0,200	0,250	0,315
M1	0,040	0,050	0,063	0,080	0,080	0,100	0,125	0,160	0,160	0,200	0,250
M2	0,032	0,040	0,050	0,063	0,063	0,080	0,100	0,125	0,125	0,160	0,200
K1	0,125	0,160	0,160	0,200	0,250	0,315	0,315	0,400	0,500	0,630	0,630
K2	0,100	0,125	0,160	0,200	0,200	0,250	0,315	0,400	0,400	0,500	0,630
N1	0,100	0,125	0,160	0,200	0,200	0,250	0,315	0,400	0,400	0,500	0,630
N2	0,125	0,160	0,160	0,200	0,250	0,315	0,315	0,400	0,500	0,630	0,630
S1	0,040	0,050	0,063	0,080	0,080	0,100	0,125	0,160	0,160	0,200	0,250
S2	0,032	0,040	0,050	0,063	0,063	0,080	0,100	0,125	0,125	0,160	0,200
H1	0,032	0,040	0,050	0,063	0,063	0,080	0,100	0,125	0,125	0,160	0,200
H2	0,025	0,032	0,040	0,050	0,050	0,063	0,080	0,100	0,100	0,125	0,160
H3	-	-	-	-	-	-	-	-	-	-	-
G1	-	-	-	-	-	-	-	-	-	-	-

Solid carbide drill; 3xD; DIN6537K; with internal coolant holes; TiAlN coated
 VHM Bohrer; 3xD; DIN6537K; mit Innenkühlung; TiAlN beschichtet

Specifications / Spezifikationen

DIN 6535 HA	DIN 6535 HE	Dc	Ds	Ls	Ln	Dn	Lt	r	z
BLDC203D074030SIK	BLDE203D074030SIK	7,4	8	41	-	-	79	-	2
BLDC203D075030SIK	BLDE203D075030SIK	7,5	8	41	-	-	79	-	2
BLDC203D076030SIK	BLDE203D076030SIK	7,6	8	41	-	-	79	-	2
BLDC203D077030SIK	BLDE203D077030SIK	7,7	8	41	-	-	79	-	2
BLDC203D078030SIK	BLDE203D078030SIK	7,8	8	41	-	-	79	-	2
BLDC203D079030SIK	BLDE203D079030SIK	7,9	8	41	-	-	79	-	2
BLDC203D080030SIK	BLDE203D080030SIK	8,0	8	41	-	-	79	-	2
BLDC203D081030SIK	BLDE203D081030SIK	8,1	10	47	-	-	89	-	2
BLDC203D082030SIK	BLDE203D082030SIK	8,2	10	47	-	-	89	-	2
BLDC203D083030SIK	BLDE203D083030SIK	8,3	10	47	-	-	89	-	2
BLDC203D084030SIK	BLDE203D084030SIK	8,4	10	47	-	-	89	-	2
BLDC203D085030SIK	BLDE203D085030SIK	8,5	10	47	-	-	89	-	2
BLDC203D086030SIK	BLDE203D086030SIK	8,6	10	47	-	-	89	-	2
BLDC203D087030SIK	BLDE203D087030SIK	8,7	10	47	-	-	89	-	2
BLDC203D088030SIK	BLDE203D088030SIK	8,8	10	47	-	-	89	-	2
BLDC203D089030SIK	BLDE203D089030SIK	8,9	10	47	-	-	89	-	2
BLDC203D090030SIK	BLDE203D090030SIK	9,0	10	47	-	-	89	-	2
BLDC203D091030SIK	BLDE203D091030SIK	9,1	10	47	-	-	89	-	2
BLDC203D092030SIK	BLDE203D092030SIK	9,2	10	47	-	-	89	-	2
BLDC203D093030SIK	BLDE203D093030SIK	9,3	10	47	-	-	89	-	2
BLDC203D094030SIK	BLDE203D094030SIK	9,4	10	47	-	-	89	-	2
BLDC203D095030SIK	BLDE203D095030SIK	9,5	10	47	-	-	89	-	2
BLDC203D096030SIK	BLDE203D096030SIK	9,6	10	47	-	-	89	-	2
BLDC203D097030SIK	BLDE203D097030SIK	9,7	10	47	-	-	89	-	2
BLDC203D098030SIK	BLDE203D098030SIK	9,8	10	47	-	-	89	-	2
BLDC203D099030SIK	BLDE203D099030SIK	9,9	10	47	-	-	89	-	2
BLDC203D100030SIK	BLDE203D100030SIK	10,0	10	47	-	-	89	-	2
BLDC203D101030SIK	BLDE203D101030SIK	10,1	12	55	-	-	102	-	2
BLDC203D102030SIK	BLDE203D102030SIK	10,2	12	55	-	-	102	-	2
BLDC203D103030SIK	BLDE203D103030SIK	10,3	12	55	-	-	102	-	2
BLDC203D104030SIK	BLDE203D104030SIK	10,4	12	55	-	-	102	-	2
BLDC203D105030SIK	BLDE203D105030SIK	10,5	12	55	-	-	102	-	2
BLDC203D106030SIK	BLDE203D106030SIK	10,6	12	55	-	-	102	-	2
BLDC203D107030SIK	BLDE203D107030SIK	10,7	12	55	-	-	102	-	2
BLDC203D108030SIK	BLDE203D108030SIK	10,8	12	55	-	-	102	-	2
BLDC203D109030SIK	BLDE203D109030SIK	10,9	12	55	-	-	102	-	2
BLDC203D110030SIK	BLDE203D110030SIK	11,0	12	55	-	-	102	-	2
BLDC203D111030SIK	BLDE203D111030SIK	11,1	12	55	-	-	102	-	2
BLDC203D112030SIK	BLDE203D112030SIK	11,2	12	55	-	-	102	-	2
BLDC203D113030SIK	BLDE203D113030SIK	11,3	12	55	-	-	102	-	2
BLDC203D114030SIK	BLDE203D114030SIK	11,4	12	55	-	-	102	-	2
BLDC203D115030SIK	BLDE203D115030SIK	11,5	12	55	-	-	102	-	2
BLDC203D116030SIK	BLDE203D116030SIK	11,6	12	55	-	-	102	-	2
BLDC203D117030SIK	BLDE203D117030SIK	11,7	12	55	-	-	102	-	2



Other dimensions on request / Andere Abmessungen auf Anfrage

Dimensions in mm / Maße in mm

Solid carbide drill; 3xD; DIN6537K; with internal coolant holes; TiAlN coated

VHM Bohrer; 3xD; DIN6537K; mit Innenkühlung; TiAlN beschichtet

Workpiece material groups and cutting speed / Werkstoffgruppen und Schnittgeschwindigkeiten

Material Material	Tensile strength Zugfestigkeit Rm [N/mm ²]	Hardness Härte [HB/HRC]	Cutting speed Vc [m/min] Schnittgeschwindigkeiten		
			min	opt	max
P1 Plain carbon steel / Unlegierter Stahl	< 600	< 230	100	110	120
P2 Alloy Steel / Legierter Stahl	< 1200	< 350	80	90	100
P3 High alloy steel and tool steel / Hochlegierter Stahl und Werkzeugstahl	< 1400	< 380	60	70	80
M1 Aust. and Ferr. Stainless steel / Aust. und Ferr. rostfreie Stähle	< 680	< 220	40	50	60
M2 Mart. Stainless steel / Mart. rostfreie Stähle	< 820	< 240	40	50	60
K1 Grey cast iron / Grauguß	-	< 280	180	200	220
K2 Ductile cast iron / Sphäroguß	-	< 320	140	160	180
N1 Non-ferrous alloys / Nichteisenmetalle	< 250	< 110	-	-	-
N2 Aluminium alloys / Aluminiumlegierungen	< 530	< 130	-	-	-
S1 High temperature alloys Fe, Ni and Co based / Warmfeste Leg. Fe, Ni und Co	< 3300	< 350	20	30	40
S2 Titanium alloys; Alpha and Beta / Titan Legierungen Alpha und Beta	< 2100	< 400	30	40	50
H1 Hardened steel / Gehärtete Stähle	-	< 54 HRC	30	40	50
H2 Hardened steel / Gehärtete Stähle	-	52-60 HRC	20	25	30
H3 Hardened steel / Gehärtete Stähle	-	> 58 HRC	-	-	-
G1 Graphite / Graphit	-	-	-	-	-

Cutting conditions / Zerspanungswerte

Material Material	f Feed per revolution [mm] / Vorschub pro Umdrehung [mm]										
	Ø 0 - 2	Ø 2 - 2,5	Ø 2,5 - 3	Ø 3 - 4	Ø 4 - 5	Ø 5 - 6	Ø 6 - 8	Ø 8 - 10	Ø 10 - 12	Ø 12 - 16	Ø 16 - 20
P1	0,080	0,100	0,125	0,160	0,160	0,200	0,250	0,315	0,315	0,400	0,500
P2	0,063	0,080	0,100	0,125	0,125	0,160	0,200	0,250	0,250	0,315	0,400
P3	0,050	0,063	0,080	0,100	0,100	0,125	0,160	0,200	0,200	0,250	0,315
M1	0,040	0,050	0,063	0,080	0,080	0,100	0,125	0,160	0,160	0,200	0,250
M2	0,032	0,040	0,050	0,063	0,063	0,080	0,100	0,125	0,125	0,160	0,200
K1	0,125	0,160	0,160	0,200	0,250	0,315	0,315	0,400	0,500	0,630	0,630
K2	0,100	0,125	0,160	0,200	0,200	0,250	0,315	0,400	0,400	0,500	0,630
N1	0,100	0,125	0,160	0,200	0,200	0,250	0,315	0,400	0,400	0,500	0,630
N2	0,125	0,160	0,160	0,200	0,250	0,315	0,315	0,400	0,500	0,630	0,630
S1	0,040	0,050	0,063	0,080	0,080	0,100	0,125	0,160	0,160	0,200	0,250
S2	0,032	0,040	0,050	0,063	0,063	0,080	0,100	0,125	0,125	0,160	0,200
H1	0,032	0,040	0,050	0,063	0,063	0,080	0,100	0,125	0,125	0,160	0,200
H2	0,025	0,032	0,040	0,050	0,050	0,063	0,080	0,100	0,100	0,125	0,160
H3	-	-	-	-	-	-	-	-	-	-	-
G1	-	-	-	-	-	-	-	-	-	-	-

Solid carbide drill; 3xD; DIN6537K; with internal coolant holes; TiAlN coated
 VHM Bohrer; 3xD; DIN6537K; mit Innenkühlung; TiAlN beschichtet

Specifications / Spezifikationen

DIN 6535 HA	DIN 6535 HE	Dc	Ds	Ls	Ln	Dn	Lt	r	z
BLDC203D118030SIK	BLDE203D118030SIK	11,8	12	55	-	-	102	-	2
BLDC203D119030SIK	BLDE203D119030SIK	11,9	12	55	-	-	102	-	2
BLDC203D120030SIK	BLDE203D120030SIK	12,0	12	55	-	-	102	-	2
BLDC203D122030SIK	BLDE203D122030SIK	12,2	14	60	-	-	107	-	2
BLDC203D125030SIK	BLDE203D125030SIK	12,5	14	60	-	-	107	-	2
BLDC203D127030SIK	BLDE203D127030SIK	12,7	14	60	-	-	107	-	2
BLDC203D130030SIK	BLDE203D130030SIK	13,0	14	60	-	-	107	-	2
BLDC203D135030SIK	BLDE203D135030SIK	13,5	14	60	-	-	107	-	2
BLDC203D137030SIK	BLDE203D137030SIK	13,7	14	60	-	-	107	-	2
BLDC203D140030SIK	BLDE203D140030SIK	14,0	14	60	-	-	107	-	2
BLDC203D142030SIK	BLDE203D142030SIK	14,2	16	65	-	-	115	-	2
BLDC203D145030SIK	BLDE203D145030SIK	14,5	16	65	-	-	115	-	2
BLDC203D147030SIK	BLDE203D147030SIK	14,7	16	65	-	-	115	-	2
BLDC203D150030SIK	BLDE203D150030SIK	15,0	16	65	-	-	115	-	2
BLDC203D152030SIK	BLDE203D152030SIK	15,2	16	65	-	-	115	-	2
BLDC203D155030SIK	BLDE203D155030SIK	15,5	16	65	-	-	115	-	2
BLDC203D157030SIK	BLDE203D157030SIK	15,7	16	65	-	-	115	-	2
BLDC203D160030SIK	BLDE203D160030SIK	16,0	16	65	-	-	115	-	2
BLDC203D165030SIK	BLDE203D165030SIK	16,5	18	73	-	-	123	-	2
BLDC203D170030SIK	BLDE203D170030SIK	17,0	18	73	-	-	123	-	2
BLDC203D175030SIK	BLDE203D175030SIK	17,5	18	73	-	-	123	-	2
BLDC203D180030SIK	BLDE203D180030SIK	18,0	18	73	-	-	123	-	2
BLDC203D185030SIK	BLDE203D185030SIK	18,5	20	79	-	-	131	-	2
BLDC203D190030SIK	BLDE203D190030SIK	19,0	20	79	-	-	131	-	2
BLDC203D195030SIK	BLDE203D195030SIK	19,5	20	79	-	-	131	-	2
BLDC203D200030SIK	BLDE203D200030SIK	20,0	20	79	-	-	131	-	2



Solid carbide drill; 5xD; DIN6537L; with internal coolant holes; TiAlN coated

VHM Bohrer; 5xD; DIN6537L; mit Innenkühlung; TiAlN beschichtet

Workpiece material groups and cutting speed / Werkstoffgruppen und Schnittgeschwindigkeiten

Material Material	Tensile strength Zugfestigkeit Rm [N/mm ²]	Hardness Härte [HB/HRC]	Cutting speed Vc [m/min] Schnittgeschwindigkeiten		
			min	opt	max
P1 Plain carbon steel / Unlegierter Stahl	< 600	< 230	120	130	140
P2 Alloy Steel / Legierter Stahl	< 1200	< 350	90	110	120
P3 High alloy steel and tool steel / Hochlegierter Stahl und Werkzeugstahl	< 1400	< 380	70	80	90
M1 Aust. and Ferr. Stainless steel / Aust. und Ferr. rostfreie Stähle	< 680	< 220	50	60	70
M2 Mart. Stainless steel / Mart. rostfreie Stähle	< 820	< 240	50	60	70
K1 Grey cast iron / Grauguß	-	< 280	160	180	200
K2 Ductile cast iron / Sphäroguß	-	< 320	120	140	160
N1 Non-ferrous alloys / Nichteisenmetalle	< 250	< 110	-	-	-
N2 Aluminium alloys / Aluminiumlegierungen	< 530	< 130	-	-	-
S1 High temperature alloys Fe, Ni and Co based / Warmfeste Leg. Fe, Ni und Co	< 3300	< 350	30	40	50
S2 Titanium alloys; Alpha and Beta / Titan Legierungen Alpha und Beta	< 2100	< 400	40	50	60
H1 Hardened steel / Gehärtete Stähle	-	< 54 HRC	40	50	60
H2 Hardened steel / Gehärtete Stähle	-	52-60 HRC	30	40	50
H3 Hardened steel / Gehärtete Stähle	-	> 58 HRC	-	-	-
G1 Graphite / Graphit	-	-	-	-	-

Cutting conditions / Zerspanungswerte

Material Material	f Feed per revolution [mm] / Vorschub pro Umdrehung [mm]										
	Ø 0 - 2	Ø 2 - 2,5	Ø 2,5 - 3	Ø 3 - 4	Ø 4 - 5	Ø 5 - 6	Ø 6 - 8	Ø 8 - 10	Ø 10 - 12	Ø 12 - 16	Ø 16 - 20
P1	0,080	0,100	0,125	0,160	0,160	0,200	0,250	0,315	0,315	0,400	0,500
P2	0,063	0,080	0,100	0,125	0,125	0,160	0,200	0,250	0,250	0,315	0,400
P3	0,050	0,063	0,080	0,100	0,100	0,125	0,160	0,200	0,200	0,250	0,315
M1	0,040	0,050	0,063	0,080	0,080	0,100	0,125	0,160	0,160	0,200	0,250
M2	0,032	0,040	0,050	0,063	0,063	0,080	0,100	0,125	0,125	0,160	0,200
K1	0,125	0,160	0,160	0,200	0,250	0,315	0,315	0,400	0,500	0,630	0,630
K2	0,100	0,125	0,160	0,200	0,200	0,250	0,315	0,400	0,400	0,500	0,630
N1	0,100	0,125	0,160	0,200	0,200	0,250	0,315	0,400	0,400	0,500	0,630
N2	0,125	0,160	0,160	0,200	0,250	0,315	0,315	0,400	0,500	0,630	0,630
S1	0,040	0,050	0,063	0,080	0,080	0,100	0,125	0,160	0,160	0,200	0,250
S2	0,032	0,040	0,050	0,063	0,063	0,080	0,100	0,125	0,125	0,160	0,200
H1	0,032	0,040	0,050	0,063	0,063	0,080	0,100	0,125	0,125	0,160	0,200
H2	0,025	0,032	0,040	0,050	0,050	0,063	0,080	0,100	0,100	0,125	0,160
H3	-	-	-	-	-	-	-	-	-	-	-
G1	-	-	-	-	-	-	-	-	-	-	-

Solid carbide drill; 5xD; DIN6537L; with internal coolant holes; TiAlN coated
 VHM Bohrer; 5xD; DIN6537L; mit Innenkühlung; TiAlN beschichtet

Specifications / Spezifikationen

DIN 6535 HA	DIN 6535 HE	Dc	Ds	Ls	Ln	Dn	Lt	r	z
BLDC205D030030SIK	BLDE205D030030SIK	3,0	6	28	-	-	66	-	2
BLDC205D031030SIK	BLDE205D031030SIK	3,1	6	28	-	-	66	-	2
BLDC205D032030SIK	BLDE205D032030SIK	3,2	6	28	-	-	66	-	2
BLDC205D033030SIK	BLDE205D033030SIK	3,3	6	28	-	-	66	-	2
BLDC205D034030SIK	BLDE205D034030SIK	3,4	6	28	-	-	66	-	2
BLDC205D035030SIK	BLDE205D035030SIK	3,5	6	28	-	-	66	-	2
BLDC205D036030SIK	BLDE205D036030SIK	3,6	6	28	-	-	66	-	2
BLDC205D037030SIK	BLDE205D037030SIK	3,7	6	28	-	-	66	-	2
BLDC205D038030SIK	BLDE205D038030SIK	3,8	6	36	-	-	74	-	2
BLDC205D039030SIK	BLDE205D039030SIK	3,9	6	36	-	-	74	-	2
BLDC205D040030SIK	BLDE205D040030SIK	4,0	6	36	-	-	74	-	2
BLDC205D041030SIK	BLDE205D041030SIK	4,1	6	36	-	-	74	-	2
BLDC205D042030SIK	BLDE205D042030SIK	4,2	6	36	-	-	74	-	2
BLDC205D043030SIK	BLDE205D043030SIK	4,3	6	36	-	-	74	-	2
BLDC205D044030SIK	BLDE205D044030SIK	4,4	6	36	-	-	74	-	2
BLDC205D045030SIK	BLDE205D045030SIK	4,5	6	36	-	-	74	-	2
BLDC205D046030SIK	BLDE205D046030SIK	4,6	6	36	-	-	74	-	2
BLDC205D047030SIK	BLDE205D047030SIK	4,7	6	36	-	-	74	-	2
BLDC205D048030SIK	BLDE205D048030SIK	4,8	6	44	-	-	82	-	2
BLDC205D049030SIK	BLDE205D049030SIK	4,9	6	44	-	-	82	-	2
BLDC205D050030SIK	BLDE205D050030SIK	5,0	6	44	-	-	82	-	2
BLDC205D051030SIK	BLDE205D051030SIK	5,1	6	44	-	-	82	-	2
BLDC205D052030SIK	BLDE205D052030SIK	5,2	6	44	-	-	82	-	2
BLDC205D053030SIK	BLDE205D053030SIK	5,3	6	44	-	-	82	-	2
BLDC205D054030SIK	BLDE205D054030SIK	5,4	6	44	-	-	82	-	2
BLDC205D055030SIK	BLDE205D055030SIK	5,5	6	44	-	-	82	-	2
BLDC205D056030SIK	BLDE205D056030SIK	5,6	6	44	-	-	82	-	2
BLDC205D057030SIK	BLDE205D057030SIK	5,7	6	44	-	-	82	-	2
BLDC205D058030SIK	BLDE205D058030SIK	5,8	6	44	-	-	82	-	2
BLDC205D059030SIK	BLDE205D059030SIK	5,9	6	44	-	-	82	-	2
BLDC205D060030SIK	BLDE205D060030SIK	6,0	6	44	-	-	82	-	2
BLDC205D061030SIK	BLDE205D061030SIK	6,1	8	53	-	-	91	-	2
BLDC205D062030SIK	BLDE205D062030SIK	6,2	8	53	-	-	91	-	2
BLDC205D063030SIK	BLDE205D063030SIK	6,3	8	53	-	-	91	-	2
BLDC205D064030SIK	BLDE205D064030SIK	6,4	8	53	-	-	91	-	2
BLDC205D065030SIK	BLDE205D065030SIK	6,5	8	53	-	-	91	-	2
BLDC205D066030SIK	BLDE205D066030SIK	6,6	8	53	-	-	91	-	2
BLDC205D067030SIK	BLDE205D067030SIK	6,7	8	53	-	-	91	-	2
BLDC205D068030SIK	BLDE205D068030SIK	6,8	8	53	-	-	91	-	2
BLDC205D069030SIK	BLDE205D069030SIK	6,9	8	53	-	-	91	-	2
BLDC205D070030SIK	BLDE205D070030SIK	7,0	8	53	-	-	91	-	2
BLDC205D071030SIK	BLDE205D071030SIK	7,1	8	53	-	-	91	-	2
BLDC205D072030SIK	BLDE205D072030SIK	7,2	8	53	-	-	91	-	2
BLDC205D073030SIK	BLDE205D073030SIK	7,3	8	53	-	-	91	-	2



Other dimensions on request / Andere Abmessungen auf Anfrage

Dimensions in mm / Maße in mm

Solid carbide drill; 5xD; DIN6537L; with internal coolant holes; TiAlN coated

VHM Bohrer; 5xD; DIN6537L; mit Innenkühlung; TiAlN beschichtet

Workpiece material groups and cutting speed / Werkstoffgruppen und Schnittgeschwindigkeiten

Material Material	Tensile strength Zugfestigkeit Rm [N/mm ²]	Hardness Härte [HB/HRC]	Cutting speed Vc [m/min] Schnittgeschwindigkeiten		
			min	opt	max
P1 Plain carbon steel / Unlegierter Stahl	< 600	< 230	120	130	140
P2 Alloy Steel / Legierter Stahl	< 1200	< 350	90	110	120
P3 High alloy steel and tool steel / Hochlegierter Stahl und Werkzeugstahl	< 1400	< 380	70	80	90
M1 Aust. and Ferr. Stainless steel / Aust. und Ferr. rostfreie Stähle	< 680	< 220	50	60	70
M2 Mart. Stainless steel / Mart. rostfreie Stähle	< 820	< 240	50	60	70
K1 Grey cast iron / Grauguß	-	< 280	160	180	200
K2 Ductile cast iron / Sphäroguß	-	< 320	120	140	160
N1 Non-ferrous alloys / Nichteisenmetalle	< 250	< 110	-	-	-
N2 Aluminium alloys / Aluminiumlegierungen	< 530	< 130	-	-	-
S1 High temperature alloys Fe, Ni and Co based / Warmfeste Leg. Fe, Ni und Co	< 3300	< 350	30	40	50
S2 Titanium alloys; Alpha and Beta / Titan Legierungen Alpha und Beta	< 2100	< 400	40	50	60
H1 Hardened steel / Gehärtete Stähle	-	< 54 HRC	40	50	60
H2 Hardened steel / Gehärtete Stähle	-	52-60 HRC	30	40	50
H3 Hardened steel / Gehärtete Stähle	-	> 58 HRC	-	-	-
G1 Graphite / Graphit	-	-	-	-	-

Cutting conditions / Zerspanungswerte

Material Material	f Feed per revolution [mm] / Vorschub pro Umdrehung [mm]										
	Ø 0 - 2	Ø 2 - 2,5	Ø 2,5 - 3	Ø 3 - 4	Ø 4 - 5	Ø 5 - 6	Ø 6 - 8	Ø 8 - 10	Ø 10 - 12	Ø 12 - 16	Ø 16 - 20
P1	0,080	0,100	0,125	0,160	0,160	0,200	0,250	0,315	0,315	0,400	0,500
P2	0,063	0,080	0,100	0,125	0,125	0,160	0,200	0,250	0,250	0,315	0,400
P3	0,050	0,063	0,080	0,100	0,100	0,125	0,160	0,200	0,200	0,250	0,315
M1	0,040	0,050	0,063	0,080	0,080	0,100	0,125	0,160	0,160	0,200	0,250
M2	0,032	0,040	0,050	0,063	0,063	0,080	0,100	0,125	0,125	0,160	0,200
K1	0,125	0,160	0,160	0,200	0,250	0,315	0,315	0,400	0,500	0,630	0,630
K2	0,100	0,125	0,160	0,200	0,200	0,250	0,315	0,400	0,400	0,500	0,630
N1	0,100	0,125	0,160	0,200	0,200	0,250	0,315	0,400	0,400	0,500	0,630
N2	0,125	0,160	0,160	0,200	0,250	0,315	0,315	0,400	0,500	0,630	0,630
S1	0,040	0,050	0,063	0,080	0,080	0,100	0,125	0,160	0,160	0,200	0,250
S2	0,032	0,040	0,050	0,063	0,063	0,080	0,100	0,125	0,125	0,160	0,200
H1	0,032	0,040	0,050	0,063	0,063	0,080	0,100	0,125	0,125	0,160	0,200
H2	0,025	0,032	0,040	0,050	0,050	0,063	0,080	0,100	0,100	0,125	0,160
H3	-	-	-	-	-	-	-	-	-	-	-
G1	-	-	-	-	-	-	-	-	-	-	-

Solid carbide drill; 5xD; DIN6537L; with internal coolant holes; TiAlN coated
 VHM Bohrer; 5xD; DIN6537L; mit Innenkühlung; TiAlN beschichtet

Specifications / Spezifikationen

DIN 6535 HA	DIN 6535 HE	Dc	Ds	Ls	Ln	Dn	Lt	r	z
BLDC205D074030SIK	BLDE205D074030SIK	7,4	8	53	-	-	91	-	2
BLDC205D075030SIK	BLDE205D075030SIK	7,5	8	53	-	-	91	-	2
BLDC205D076030SIK	BLDE205D076030SIK	7,6	8	53	-	-	91	-	2
BLDC205D077030SIK	BLDE205D077030SIK	7,7	8	53	-	-	91	-	2
BLDC205D078030SIK	BLDE205D078030SIK	7,8	8	53	-	-	91	-	2
BLDC205D079030SIK	BLDE205D079030SIK	7,9	8	53	-	-	91	-	2
BLDC205D080030SIK	BLDE205D080030SIK	8,0	8	53	-	-	91	-	2
BLDC205D081030SIK	BLDE205D081030SIK	8,1	10	61	-	-	103	-	2
BLDC205D082030SIK	BLDE205D082030SIK	8,2	10	61	-	-	103	-	2
BLDC205D083030SIK	BLDE205D083030SIK	8,3	10	61	-	-	103	-	2
BLDC205D084030SIK	BLDE205D084030SIK	8,4	10	61	-	-	103	-	2
BLDC205D085030SIK	BLDE205D085030SIK	8,5	10	61	-	-	103	-	2
BLDC205D086030SIK	BLDE205D086030SIK	8,6	10	61	-	-	103	-	2
BLDC205D087030SIK	BLDE205D087030SIK	8,7	10	61	-	-	103	-	2
BLDC205D088030SIK	BLDE205D088030SIK	8,8	10	61	-	-	103	-	2
BLDC205D089030SIK	BLDE205D089030SIK	8,9	10	61	-	-	103	-	2
BLDC205D090030SIK	BLDE205D090030SIK	9,0	10	61	-	-	103	-	2
BLDC205D091030SIK	BLDE205D091030SIK	9,1	10	61	-	-	103	-	2
BLDC205D092030SIK	BLDE205D092030SIK	9,2	10	61	-	-	103	-	2
BLDC205D093030SIK	BLDE205D093030SIK	9,3	10	61	-	-	103	-	2
BLDC205D094030SIK	BLDE205D094030SIK	9,4	10	61	-	-	103	-	2
BLDC205D095030SIK	BLDE205D095030SIK	9,5	10	61	-	-	103	-	2
BLDC205D096030SIK	BLDE205D096030SIK	9,6	10	61	-	-	103	-	2
BLDC205D097030SIK	BLDE205D097030SIK	9,7	10	61	-	-	103	-	2
BLDC205D098030SIK	BLDE205D098030SIK	9,8	10	61	-	-	103	-	2
BLDC205D099030SIK	BLDE205D099030SIK	9,9	10	61	-	-	103	-	2
BLDC205D100030SIK	BLDE205D100030SIK	10,0	10	61	-	-	103	-	2
BLDC205D101030SIK	BLDE205D101030SIK	10,1	12	71	-	-	118	-	2
BLDC205D102030SIK	BLDE205D102030SIK	10,2	12	71	-	-	118	-	2
BLDC205D103030SIK	BLDE205D103030SIK	10,3	12	71	-	-	118	-	2
BLDC205D104030SIK	BLDE205D104030SIK	10,4	12	71	-	-	118	-	2
BLDC205D105030SIK	BLDE205D105030SIK	10,5	12	71	-	-	118	-	2
BLDC205D106030SIK	BLDE205D106030SIK	10,6	12	71	-	-	118	-	2
BLDC205D107030SIK	BLDE205D107030SIK	10,7	12	71	-	-	118	-	2
BLDC205D108030SIK	BLDE205D108030SIK	10,8	12	71	-	-	118	-	2
BLDC205D109030SIK	BLDE205D109030SIK	10,9	12	71	-	-	118	-	2
BLDC205D110030SIK	BLDE205D110030SIK	11,0	12	71	-	-	118	-	2
BLDC205D111030SIK	BLDE205D111030SIK	11,1	12	71	-	-	118	-	2
BLDC205D112030SIK	BLDE205D112030SIK	11,2	12	71	-	-	118	-	2
BLDC205D113030SIK	BLDE205D113030SIK	11,3	12	71	-	-	118	-	2
BLDC205D114030SIK	BLDE205D114030SIK	11,4	12	71	-	-	118	-	2
BLDC205D115030SIK	BLDE205D115030SIK	11,5	12	71	-	-	118	-	2
BLDC205D116030SIK	BLDE205D116030SIK	11,6	12	71	-	-	118	-	2
BLDC205D117030SIK	BLDE205D117030SIK	11,7	12	71	-	-	118	-	2



Other dimensions on request / Andere Abmessungen auf Anfrage

Dimensions in mm / Maße in mm

Solid carbide drill; 5xD; DIN6537L; with internal coolant holes; TiAlN coated

VHM Bohrer; 5xD; DIN6537L; mit Innenkühlung; TiAlN beschichtet

Workpiece material groups and cutting speed / Werkstoffgruppen und Schnittgeschwindigkeiten

Material Material	Tensile strength Zugfestigkeit Rm [N/mm ²]	Hardness Härte [HB/HRC]	Cutting speed Vc [m/min] Schnittgeschwindigkeiten		
			min	opt	max
P1 Plain carbon steel / Unlegierter Stahl	< 600	< 230	120	130	140
P2 Alloy Steel / Legierter Stahl	< 1200	< 350	90	110	120
P3 High alloy steel and tool steel / Hochlegierter Stahl und Werkzeugstahl	< 1400	< 380	70	80	90
M1 Aust. and Ferr. Stainless steel / Aust. und Ferr. rostfreie Stähle	< 680	< 220	50	60	70
M2 Mart. Stainless steel / Mart. rostfreie Stähle	< 820	< 240	50	60	70
K1 Grey cast iron / Grauguß	-	< 280	160	180	200
K2 Ductile cast iron / Sphäroguß	-	< 320	120	140	160
N1 Non-ferrous alloys / Nichteisenmetalle	< 250	< 110	-	-	-
N2 Aluminium alloys / Aluminiumlegierungen	< 530	< 130	-	-	-
S1 High temperature alloys Fe, Ni and Co based / Warmfeste Leg. Fe, Ni und Co	< 3300	< 350	30	40	50
S2 Titanium alloys; Alpha and Beta / Titan Legierungen Alpha und Beta	< 2100	< 400	40	50	60
H1 Hardened steel / Gehärtete Stähle	-	< 54 HRC	40	50	60
H2 Hardened steel / Gehärtete Stähle	-	52-60 HRC	30	40	50
H3 Hardened steel / Gehärtete Stähle	-	> 58 HRC	-	-	-
G1 Graphite / Graphit	-	-	-	-	-

Cutting conditions / Zerspanungswerte

Material Material	f Feed per revolution [mm] / Vorschub pro Umdrehung [mm]										
	Ø 0 - 2	Ø 2 - 2,5	Ø 2,5 - 3	Ø 3 - 4	Ø 4 - 5	Ø 5 - 6	Ø 6 - 8	Ø 8 - 10	Ø 10 - 12	Ø 12 - 16	Ø 16 - 20
P1	0,080	0,100	0,125	0,160	0,160	0,200	0,250	0,315	0,315	0,400	0,500
P2	0,063	0,080	0,100	0,125	0,125	0,160	0,200	0,250	0,250	0,315	0,400
P3	0,050	0,063	0,080	0,100	0,100	0,125	0,160	0,200	0,200	0,250	0,315
M1	0,040	0,050	0,063	0,080	0,080	0,100	0,125	0,160	0,160	0,200	0,250
M2	0,032	0,040	0,050	0,063	0,063	0,080	0,100	0,125	0,125	0,160	0,200
K1	0,125	0,160	0,160	0,200	0,250	0,315	0,315	0,400	0,500	0,630	0,630
K2	0,100	0,125	0,160	0,200	0,200	0,250	0,315	0,400	0,400	0,500	0,630
N1	0,100	0,125	0,160	0,200	0,200	0,250	0,315	0,400	0,400	0,500	0,630
N2	0,125	0,160	0,160	0,200	0,250	0,315	0,315	0,400	0,500	0,630	0,630
S1	0,040	0,050	0,063	0,080	0,080	0,100	0,125	0,160	0,160	0,200	0,250
S2	0,032	0,040	0,050	0,063	0,063	0,080	0,100	0,125	0,125	0,160	0,200
H1	0,032	0,040	0,050	0,063	0,063	0,080	0,100	0,125	0,125	0,160	0,200
H2	0,025	0,032	0,040	0,050	0,050	0,063	0,080	0,100	0,100	0,125	0,160
H3	-	-	-	-	-	-	-	-	-	-	-
G1	-	-	-	-	-	-	-	-	-	-	-

Solid carbide drill; 5xD; DIN6537L; with internal coolant holes; TiAlN coated
 VHM Bohrer; 5xD; DIN6537L; mit Innenkühlung; TiAlN beschichtet

Specifications / Spezifikationen

DIN 6535 HA	DIN 6535 HE	Dc	Ds	Ls	Ln	Dn	Lt	r	z
BLDC205D118030SIK	BLDE205D118030SIK	11,8	12	71	-	-	118	-	2
BLDC205D119030SIK	BLDE205D119030SIK	11,9	12	71	-	-	118	-	2
BLDC205D120030SIK	BLDE205D120030SIK	12,0	12	71	-	-	118	-	2
BLDC205D125030SIK	BLDE205D125030SIK	12,5	14	77	-	-	124	-	2
BLDC205D128030SIK	BLDE205D128030SIK	12,8	14	77	-	-	124	-	2
BLDC205D130030SIK	BLDE205D130030SIK	13,0	14	77	-	-	124	-	2
BLDC205D135030SIK	BLDE205D135030SIK	13,5	14	77	-	-	124	-	2
BLDC205D138030SIK	BLDE205D138030SIK	13,8	14	77	-	-	124	-	2
BLDC205D140030SIK	BLDE205D140030SIK	14,0	14	77	-	-	124	-	2
BLDC205D145030SIK	BLDE205D145030SIK	14,5	16	83	-	-	133	-	2
BLDC205D148030SIK	BLDE205D148030SIK	14,8	16	83	-	-	133	-	2
BLDC205D150030SIK	BLDE205D150030SIK	15,0	16	83	-	-	133	-	2
BLDC205D158030SIK	BLDE205D158030SIK	15,8	16	83	-	-	133	-	2
BLDC205D160030SIK	BLDE205D160030SIK	16,0	16	83	-	-	133	-	2
BLDC205D165030SIK	BLDE205D165030SIK	16,5	18	93	-	-	143	-	2
BLDC205D170030SIK	BLDE205D170030SIK	17,0	18	93	-	-	143	-	2
BLDC205D175030SIK	BLDE205D175030SIK	17,5	18	93	-	-	143	-	2
BLDC205D180030SIK	BLDE205D180030SIK	18,0	18	93	-	-	143	-	2
BLDC205D185030SIK	BLDE205D185030SIK	18,5	20	101	-	-	153	-	2
BLDC205D190030SIK	BLDE205D190030SIK	19,0	20	101	-	-	153	-	2
BLDC205D195030SIK	BLDE205D195030SIK	19,5	20	101	-	-	153	-	2
BLDC205D200030SIK	BLDE205D200030SIK	20,0	20	101	-	-	153	-	2



Solid carbide drill; 8xD; SCT norm; with internal coolant holes; TiAlN coated

VHM Bohrer; 8xD; SCT Norm; mit Innenkühlung; TiAlN beschichtet

Workpiece material groups and cutting speed / Werkstoffgruppen und Schnittgeschwindigkeiten

Material Material	Tensile strength Zugfestigkeit Rm [N/mm ²]	Hardness Härte [HB/HRC]	Cutting speed Vc [m/min] Schnittgeschwindigkeiten		
			min	opt	max
P1 Plain carbon steel / Unlegierter Stahl	< 600	< 230	120	130	140
P2 Alloy Steel / Legierter Stahl	< 1200	< 350	90	110	120
P3 High alloy steel and tool steel / Hochlegierter Stahl und Werkzeugstahl	< 1400	< 380	70	80	90
M1 Aust. and Ferr. Stainless steel / Aust. und Ferr. rostfreie Stähle	< 680	< 220	50	60	70
M2 Mart. Stainless steel / Mart. rostfreie Stähle	< 820	< 240	50	60	70
K1 Grey cast iron / Grauguß	-	< 280	160	180	200
K2 Ductile cast iron / Sphäroguß	-	< 320	120	140	160
N1 Non-ferrous alloys / Nichteisenmetalle	< 250	< 110	-	-	-
N2 Aluminium alloys / Aluminiumlegierungen	< 530	< 130	-	-	-
S1 High temperature alloys Fe, Ni and Co based / Warmfeste Leg. Fe, Ni und Co	< 3300	< 350	30	40	50
S2 Titanium alloys; Alpha and Beta / Titan Legierungen Alpha und Beta	< 2100	< 400	40	50	60
H1 Hardened steel / Gehärtete Stähle	-	< 54 HRC	40	50	60
H2 Hardened steel / Gehärtete Stähle	-	52-60 HRC	30	40	50
H3 Hardened steel / Gehärtete Stähle	-	> 58 HRC	-	-	-
G1 Graphite / Graphit	-	-	-	-	-

Cutting conditions / Zerspanungswerte

Material Material	f Feed per revolution [mm] / Vorschub pro Umdrehung [mm]										
	Ø 0 - 2	Ø 2 - 2,5	Ø 2,5 - 3	Ø 3 - 4	Ø 4 - 5	Ø 5 - 6	Ø 6 - 8	Ø 8 - 10	Ø 10 - 12	Ø 12 - 16	Ø 16 - 20
P1	0,080	0,100	0,125	0,160	0,160	0,200	0,250	0,315	0,315	0,400	0,500
P2	0,063	0,080	0,100	0,125	0,125	0,160	0,200	0,250	0,250	0,315	0,400
P3	0,050	0,063	0,080	0,100	0,100	0,125	0,160	0,200	0,200	0,250	0,315
M1	0,040	0,050	0,063	0,080	0,080	0,100	0,125	0,160	0,160	0,200	0,250
M2	0,032	0,040	0,050	0,063	0,063	0,080	0,100	0,125	0,125	0,160	0,200
K1	0,125	0,160	0,160	0,200	0,250	0,315	0,315	0,400	0,500	0,630	0,630
K2	0,100	0,125	0,160	0,200	0,200	0,250	0,315	0,400	0,400	0,500	0,630
N1	0,100	0,125	0,160	0,200	0,200	0,250	0,315	0,400	0,400	0,500	0,630
N2	0,125	0,160	0,160	0,200	0,250	0,315	0,315	0,400	0,500	0,630	0,630
S1	0,040	0,050	0,063	0,080	0,080	0,100	0,125	0,160	0,160	0,200	0,250
S2	0,032	0,040	0,050	0,063	0,063	0,080	0,100	0,125	0,125	0,160	0,200
H1	0,032	0,040	0,050	0,063	0,063	0,080	0,100	0,125	0,125	0,160	0,200
H2	0,025	0,032	0,040	0,050	0,050	0,063	0,080	0,100	0,100	0,125	0,160
H3	-	-	-	-	-	-	-	-	-	-	-
G1	-	-	-	-	-	-	-	-	-	-	-

Solid carbide drill; 8xD; SCT norm; with internal coolant holes; TiAlN coated
 VHM Bohrer; 8xD; SCT Norm; mit Innenkühlung; TiAlN beschichtet

Specifications / Spezifikationen

DIN 6535 HA	DIN 6535 HE	Dc	Ds	Ls	Ln	Dn	Lt	r	z
BLDC208D030030SIK	BLDE208D030030SIK	3,0	6	30	-	-	70	-	2
BLDC208D031030SIK	BLDE208D031030SIK	3,1	6	30	-	-	70	-	2
BLDC208D032030SIK	BLDE208D032030SIK	3,2	6	30	-	-	70	-	2
BLDC208D033030SIK	BLDE208D033030SIK	3,3	6	30	-	-	70	-	2
BLDC208D034030SIK	BLDE208D034030SIK	3,4	6	35	-	-	75	-	2
BLDC208D035030SIK	BLDE208D035030SIK	3,5	6	35	-	-	75	-	2
BLDC208D036030SIK	BLDE208D036030SIK	3,6	6	35	-	-	75	-	2
BLDC208D037030SIK	BLDE208D037030SIK	3,7	6	35	-	-	75	-	2
BLDC208D038030SIK	BLDE208D038030SIK	3,8	6	37	-	-	75	-	2
BLDC208D039030SIK	BLDE208D039030SIK	3,9	6	37	-	-	75	-	2
BLDC208D040030SIK	BLDE208D040030SIK	4,0	6	37	-	-	75	-	2
BLDC208D041030SIK	BLDE208D041030SIK	4,1	6	37	-	-	75	-	2
BLDC208D042030SIK	BLDE208D042030SIK	4,2	6	37	-	-	75	-	2
BLDC208D043030SIK	BLDE208D043030SIK	4,3	6	45	-	-	85	-	2
BLDC208D044030SIK	BLDE208D044030SIK	4,4	6	45	-	-	85	-	2
BLDC208D045030SIK	BLDE208D045030SIK	4,5	6	45	-	-	85	-	2
BLDC208D046030SIK	BLDE208D046030SIK	4,6	6	45	-	-	85	-	2
BLDC208D047030SIK	BLDE208D047030SIK	4,7	6	45	-	-	85	-	2
BLDC208D048030SIK	BLDE208D048030SIK	4,8	6	50	-	-	90	-	2
BLDC208D049030SIK	BLDE208D049030SIK	4,9	6	50	-	-	90	-	2
BLDC208D050030SIK	BLDE208D050030SIK	5,0	6	50	-	-	90	-	2
BLDC208D051030SIK	BLDE208D051030SIK	5,1	6	50	-	-	90	-	2
BLDC208D052030SIK	BLDE208D052030SIK	5,2	6	50	-	-	90	-	2
BLDC208D053030SIK	BLDE208D053030SIK	5,3	6	50	-	-	90	-	2
BLDC208D054030SIK	BLDE208D054030SIK	5,4	6	57	-	-	97	-	2
BLDC208D055030SIK	BLDE208D055030SIK	5,5	6	57	-	-	97	-	2
BLDC208D056030SIK	BLDE208D056030SIK	5,6	6	57	-	-	97	-	2
BLDC208D057030SIK	BLDE208D057030SIK	5,7	6	57	-	-	97	-	2
BLDC208D059030SIK	BLDE208D059030SIK	5,9	6	57	-	-	97	-	2
BLDC208D060030SIK	BLDE208D060030SIK	6,0	6	57	-	-	97	-	2
BLDC208D061030SIK	BLDE208D061030SIK	6,1	8	66	-	-	106	-	2
BLDC208D062030SIK	BLDE208D062030SIK	6,2	8	66	-	-	106	-	2
BLDC208D063030SIK	BLDE208D063030SIK	6,3	8	66	-	-	106	-	2
BLDC208D064030SIK	BLDE208D064030SIK	6,4	8	66	-	-	106	-	2
BLDC208D065030SIK	BLDE208D065030SIK	6,5	8	66	-	-	106	-	2
BLDC208D066030SIK	BLDE208D066030SIK	6,6	8	66	-	-	106	-	2
BLDC208D067030SIK	BLDE208D067030SIK	6,7	8	66	-	-	106	-	2
BLDC208D068030SIK	BLDE208D068030SIK	6,8	8	66	-	-	106	-	2
BLDC208D069030SIK	BLDE208D069030SIK	6,9	8	76	-	-	116	-	2
BLDC208D070030SIK	BLDE208D070030SIK	7,0	8	76	-	-	116	-	2
BLDC208D071030SIK	BLDE208D071030SIK	7,1	8	76	-	-	116	-	2
BLDC208D072030SIK	BLDE208D072030SIK	7,2	8	76	-	-	116	-	2
BLDC208D073030SIK	BLDE208D073030SIK	7,3	8	76	-	-	116	-	2
BLDC208D074030SIK	BLDE208D074030SIK	7,4	8	76	-	-	116	-	2



Other dimensions on request / Andere Abmessungen auf Anfrage

Dimensions in mm / Maße in mm

Solid carbide drill; 8xD; SCT norm; with internal coolant holes; TiAlN coated

VHM Bohrer; 8xD; SCT Norm; mit Innenkühlung; TiAlN beschichtet

Workpiece material groups and cutting speed / Werkstoffgruppen und Schnittgeschwindigkeiten

Material Material	Tensile strength Zugfestigkeit Rm [N/mm ²]	Hardness Härte [HB/HRC]	Cutting speed Vc [m/min] Schnittgeschwindigkeiten		
			min	opt	max
P1 Plain carbon steel / Unlegierter Stahl	< 600	< 230	120	130	140
P2 Alloy Steel / Legierter Stahl	< 1200	< 350	90	110	120
P3 High alloy steel and tool steel / Hochlegierter Stahl und Werkzeugstahl	< 1400	< 380	70	80	90
M1 Aust. and Ferr. Stainless steel / Aust. und Ferr. rostfreie Stähle	< 680	< 220	50	60	70
M2 Mart. Stainless steel / Mart. rostfreie Stähle	< 820	< 240	50	60	70
K1 Grey cast iron / Grauguß	-	< 280	160	180	200
K2 Ductile cast iron / Sphäroguß	-	< 320	120	140	160
N1 Non-ferrous alloys / Nichteisenmetalle	< 250	< 110	-	-	-
N2 Aluminium alloys / Aluminiumlegierungen	< 530	< 130	-	-	-
S1 High temperature alloys Fe, Ni and Co based / Warmfeste Leg. Fe, Ni und Co	< 3300	< 350	30	40	50
S2 Titanium alloys; Alpha and Beta / Titan Legierungen Alpha und Beta	< 2100	< 400	40	50	60
H1 Hardened steel / Gehärtete Stähle	-	< 54 HRC	40	50	60
H2 Hardened steel / Gehärtete Stähle	-	52-60 HRC	30	40	50
H3 Hardened steel / Gehärtete Stähle	-	> 58 HRC	-	-	-
G1 Graphite / Graphit	-	-	-	-	-

Cutting conditions / Zerspanungswerte

Material Material	f Feed per revolution [mm] / Vorschub pro Umdrehung [mm]										
	Ø 0 - 2	Ø 2 - 2,5	Ø 2,5 - 3	Ø 3 - 4	Ø 4 - 5	Ø 5 - 6	Ø 6 - 8	Ø 8 - 10	Ø 10 - 12	Ø 12 - 16	Ø 16 - 20
P1	0,080	0,100	0,125	0,160	0,160	0,200	0,250	0,315	0,315	0,400	0,500
P2	0,063	0,080	0,100	0,125	0,125	0,160	0,200	0,250	0,250	0,315	0,400
P3	0,050	0,063	0,080	0,100	0,100	0,125	0,160	0,200	0,200	0,250	0,315
M1	0,040	0,050	0,063	0,080	0,080	0,100	0,125	0,160	0,160	0,200	0,250
M2	0,032	0,040	0,050	0,063	0,063	0,080	0,100	0,125	0,125	0,160	0,200
K1	0,125	0,160	0,160	0,200	0,250	0,315	0,315	0,400	0,500	0,630	0,630
K2	0,100	0,125	0,160	0,200	0,200	0,250	0,315	0,400	0,400	0,500	0,630
N1	0,100	0,125	0,160	0,200	0,200	0,250	0,315	0,400	0,400	0,500	0,630
N2	0,125	0,160	0,160	0,200	0,250	0,315	0,315	0,400	0,500	0,630	0,630
S1	0,040	0,050	0,063	0,080	0,080	0,100	0,125	0,160	0,160	0,200	0,250
S2	0,032	0,040	0,050	0,063	0,063	0,080	0,100	0,125	0,125	0,160	0,200
H1	0,032	0,040	0,050	0,063	0,063	0,080	0,100	0,125	0,125	0,160	0,200
H2	0,025	0,032	0,040	0,050	0,050	0,063	0,080	0,100	0,100	0,125	0,160
H3	-	-	-	-	-	-	-	-	-	-	-
G1	-	-	-	-	-	-	-	-	-	-	-

Solid carbide drill; 8xD; SCT norm; with internal coolant holes; TiAlN coated
 VHM Bohrer; 8xD; SCT Norm; mit Innenkühlung; TiAlN beschichtet

Specifications / Spezifikationen

DIN 6535 HA	DIN 6535 HE	Dc	Ds	Ls	Ln	Dn	Lt	r	z
BLDC208D075030SIK	BLDE208D075030SIK	7,5	8	76	-	-	116	-	2
BLDC208D076030SIK	BLDE208D076030SIK	7,6	8	76	-	-	116	-	2
BLDC208D077030SIK	BLDE208D077030SIK	7,7	8	76	-	-	116	-	2
BLDC208D078030SIK	BLDE208D078030SIK	7,8	8	76	-	-	116	-	2
BLDC208D079030SIK	BLDE208D079030SIK	7,9	8	76	-	-	116	-	2
BLDC208D080030SIK	BLDE208D080030SIK	8,0	8	76	-	-	116	-	2
BLDC208D081030SIK	BLDE208D081030SIK	8,1	10	87	-	-	131	-	2
BLDC208D082030SIK	BLDE208D082030SIK	8,2	10	87	-	-	131	-	2
BLDC208D083030SIK	BLDE208D083030SIK	8,3	10	87	-	-	131	-	2
BLDC208D084030SIK	BLDE208D084030SIK	8,4	10	87	-	-	131	-	2
BLDC208D085030SIK	BLDE208D085030SIK	8,5	10	87	-	-	131	-	2
BLDC208D086030SIK	BLDE208D086030SIK	8,6	10	87	-	-	131	-	2
BLDC208D087030SIK	BLDE208D087030SIK	8,7	10	87	-	-	131	-	2
BLDC208D088030SIK	BLDE208D088030SIK	8,8	10	87	-	-	131	-	2
BLDC208D089030SIK	BLDE208D089030SIK	8,9	10	87	-	-	131	-	2
BLDC208D090030SIK	BLDE208D090030SIK	9,0	10	87	-	-	131	-	2
BLDC208D091030SIK	BLDE208D091030SIK	9,1	10	95	-	-	139	-	2
BLDC208D092030SIK	BLDE208D092030SIK	9,2	10	95	-	-	139	-	2
BLDC208D093030SIK	BLDE208D093030SIK	9,3	10	95	-	-	139	-	2
BLDC208D094030SIK	BLDE208D094030SIK	9,4	10	95	-	-	139	-	2
BLDC208D095030SIK	BLDE208D095030SIK	9,5	10	95	-	-	139	-	2
BLDC208D096030SIK	BLDE208D096030SIK	9,6	10	95	-	-	139	-	2
BLDC208D097030SIK	BLDE208D097030SIK	9,7	10	95	-	-	139	-	2
BLDC208D098030SIK	BLDE208D098030SIK	9,8	10	95	-	-	139	-	2
BLDC208D099030SIK	BLDE208D099030SIK	9,9	10	95	-	-	139	-	2
BLDC208D100030SIK	BLDE208D100030SIK	10,0	10	95	-	-	139	-	2
BLDC208D101030SIK	BLDE208D101030SIK	10,1	12	106	-	-	155	-	2
BLDC208D102030SIK	BLDE208D102030SIK	10,2	12	106	-	-	155	-	2
BLDC208D103030SIK	BLDE208D103030SIK	10,3	12	106	-	-	155	-	2
BLDC208D104030SIK	BLDE208D104030SIK	10,4	12	106	-	-	155	-	2
BLDC208D105030SIK	BLDE208D105030SIK	10,5	12	106	-	-	155	-	2
BLDC208D106030SIK	BLDE208D106030SIK	10,6	12	106	-	-	155	-	2
BLDC208D107030SIK	BLDE208D107030SIK	10,7	12	106	-	-	155	-	2
BLDC208D108030SIK	BLDE208D108030SIK	10,8	12	106	-	-	155	-	2
BLDC208D109030SIK	BLDE208D109030SIK	10,9	12	106	-	-	155	-	2
BLDC208D110030SIK	BLDE208D110030SIK	11,0	12	106	-	-	155	-	2
BLDC208D111030SIK	BLDE208D111030SIK	11,1	12	114	-	-	163	-	2
BLDC208D112030SIK	BLDE208D112030SIK	11,2	12	114	-	-	163	-	2
BLDC208D113030SIK	BLDE208D113030SIK	11,3	12	114	-	-	163	-	2
BLDC208D114030SIK	BLDE208D114030SIK	11,4	12	114	-	-	163	-	2
BLDC208D115030SIK	BLDE208D115030SIK	11,5	12	114	-	-	163	-	2
BLDC208D116030SIK	BLDE208D116030SIK	11,6	12	114	-	-	163	-	2
BLDC208D117030SIK	BLDE208D117030SIK	11,7	12	114	-	-	163	-	2
BLDC208D118030SIK	BLDE208D118030SIK	11,8	12	114	-	-	163	-	2



Other dimensions on request / Andere Abmessungen auf Anfrage

Dimensions in mm / Maße in mm

Solid carbide drill; 8xD; SCT norm; with internal coolant holes; TiAlN coated

VHM Bohrer; 8xD; SCT Norm; mit Innenkühlung; TiAlN beschichtet

Workpiece material groups and cutting speed / Werkstoffgruppen und Schnittgeschwindigkeiten

Material Material	Tensile strength Zugfestigkeit Rm [N/mm ²]	Hardness Härte [HB/HRC]	Cutting speed Vc [m/min] Schnittgeschwindigkeiten		
			min	opt	max
P1 Plain carbon steel / Unlegierter Stahl	< 600	< 230	120	130	140
P2 Alloy Steel / Legierter Stahl	< 1200	< 350	90	110	120
P3 High alloy steel and tool steel / Hochlegierter Stahl und Werkzeugstahl	< 1400	< 380	70	80	90
M1 Aust. and Ferr. Stainless steel / Aust. und Ferr. rostfreie Stähle	< 680	< 220	50	60	70
M2 Mart. Stainless steel / Mart. rostfreie Stähle	< 820	< 240	50	60	70
K1 Grey cast iron / Grauguß	-	< 280	160	180	200
K2 Ductile cast iron / Sphäroguß	-	< 320	120	140	160
N1 Non-ferrous alloys / Nichteisenmetalle	< 250	< 110	-	-	-
N2 Aluminium alloys / Aluminiumlegierungen	< 530	< 130	-	-	-
S1 High temperature alloys Fe, Ni and Co based / Warmfeste Leg. Fe, Ni und Co	< 3300	< 350	30	40	50
S2 Titanium alloys; Alpha and Beta / Titan Legierungen Alpha und Beta	< 2100	< 400	40	50	60
H1 Hardened steel / Gehärtete Stähle	-	< 54 HRC	40	50	60
H2 Hardened steel / Gehärtete Stähle	-	52-60 HRC	30	40	50
H3 Hardened steel / Gehärtete Stähle	-	> 58 HRC	-	-	-
G1 Graphite / Graphit	-	-	-	-	-

Cutting conditions / Zerspanungswerte

Material Material	f Feed per revolution [mm] / Vorschub pro Umdrehung [mm]										
	Ø 0 - 2	Ø 2 - 2,5	Ø 2,5 - 3	Ø 3 - 4	Ø 4 - 5	Ø 5 - 6	Ø 6 - 8	Ø 8 - 10	Ø 10 - 12	Ø 12 - 16	Ø 16 - 20
P1	0,080	0,100	0,125	0,160	0,160	0,200	0,250	0,315	0,315	0,400	0,500
P2	0,063	0,080	0,100	0,125	0,125	0,160	0,200	0,250	0,250	0,315	0,400
P3	0,050	0,063	0,080	0,100	0,100	0,125	0,160	0,200	0,200	0,250	0,315
M1	0,040	0,050	0,063	0,080	0,080	0,100	0,125	0,160	0,160	0,200	0,250
M2	0,032	0,040	0,050	0,063	0,063	0,080	0,100	0,125	0,125	0,160	0,200
K1	0,125	0,160	0,160	0,200	0,250	0,315	0,315	0,400	0,500	0,630	0,630
K2	0,100	0,125	0,160	0,200	0,200	0,250	0,315	0,400	0,400	0,500	0,630
N1	0,100	0,125	0,160	0,200	0,200	0,250	0,315	0,400	0,400	0,500	0,630
N2	0,125	0,160	0,160	0,200	0,250	0,315	0,315	0,400	0,500	0,630	0,630
S1	0,040	0,050	0,063	0,080	0,080	0,100	0,125	0,160	0,160	0,200	0,250
S2	0,032	0,040	0,050	0,063	0,063	0,080	0,100	0,125	0,125	0,160	0,200
H1	0,032	0,040	0,050	0,063	0,063	0,080	0,100	0,125	0,125	0,160	0,200
H2	0,025	0,032	0,040	0,050	0,050	0,063	0,080	0,100	0,100	0,125	0,160
H3	-	-	-	-	-	-	-	-	-	-	-
G1	-	-	-	-	-	-	-	-	-	-	-

Solid carbide drill; 8xD; SCT norm; with internal coolant holes; TiAlN coated
 VHM Bohrer; 8xD; SCT Norm; mit Innenkühlung; TiAlN beschichtet

Specifications / Spezifikationen

DIN 6535 HA	DIN 6535 HE	Dc	Ds	Ls	Ln	Dn	Lt	r	z
BLDC208D119030SIK	BLDE208D119030SIK	11,9	12	114	-	-	163	-	2
BLDC208D120030SIK	BLDE208D120030SIK	12,0	12	114	-	-	163	-	2
BLDC208D121030SIK	BLDE208D121030SIK	12,1	14	133	-	-	182	-	2
BLDC208D122030SIK	BLDE208D122030SIK	12,2	14	133	-	-	182	-	2
BLDC208D123030SIK	BLDE208D123030SIK	12,3	14	133	-	-	182	-	2
BLDC208D125030SIK	BLDE208D125030SIK	12,5	14	133	-	-	182	-	2
BLDC208D127030SIK	BLDE208D127030SIK	12,7	14	133	-	-	182	-	2
BLDC208D130030SIK	BLDE208D130030SIK	13,0	14	133	-	-	182	-	2
BLDC208D131030SIK	BLDE208D131030SIK	13,1	14	133	-	-	182	-	2
BLDC208D135030SIK	BLDE208D135030SIK	13,5	14	133	-	-	182	-	2
BLDC208D140030SIK	BLDE208D140030SIK	14,0	14	133	-	-	182	-	2
BLDC208D141030SIK	BLDE208D141030SIK	14,1	16	152	-	-	204	-	2
BLDC208D142030SIK	BLDE208D142030SIK	14,2	16	152	-	-	204	-	2
BLDC208D145030SIK	BLDE208D145030SIK	14,5	16	152	-	-	204	-	2
BLDC208D150030SIK	BLDE208D150030SIK	15,0	16	152	-	-	204	-	2
BLDC208D151030SIK	BLDE208D151030SIK	15,1	16	152	-	-	204	-	2
BLDC208D155030SIK	BLDE208D155030SIK	15,5	16	152	-	-	204	-	2
BLDC208D160030SIK	BLDE208D160030SIK	16,0	16	152	-	-	204	-	2
BLDC208D165030SIK	BLDE208D165030SIK	16,5	18	171	-	-	223	-	2
BLDC208D169030SIK	BLDE208D169030SIK	16,9	18	171	-	-	223	-	2
BLDC208D170030SIK	BLDE208D170030SIK	17,0	18	171	-	-	223	-	2
BLDC208D175030SIK	BLDE208D175030SIK	17,5	18	171	-	-	223	-	2
BLDC208D180030SIK	BLDE208D180030SIK	18,0	18	171	-	-	223	-	2
BLDC208D185030SIK	BLDE208D185030SIK	18,5	20	190	-	-	244	-	2
BLDC208D189030SIK	BLDE208D189030SIK	18,9	20	190	-	-	244	-	2
BLDC208D190030SIK	BLDE208D190030SIK	19,0	20	190	-	-	244	-	2
BLDC208D195030SIK	BLDE208D195030SIK	19,5	20	190	-	-	244	-	2
BLDC208D200030SIK	BLDE208D200030SIK	20,0	20	190	-	-	244	-	2



Solid carbide drill; 12xD; SCT norm; with internal coolant holes; TiAlN coated
VHM Bohrer; 12xD; SCT Norm; mit Innenkühlung; TiAlN beschichtet

Workpiece material groups and cutting speed / Werkstoffgruppen und Schnittgeschwindigkeiten

Material Material	Tensile strength Zugfestigkeit Rm [N/mm ²]	Hardness Härte [HB/HRC]	Cutting speed Vc [m/min] Schnittgeschwindigkeiten		
			min	opt	max
P1 Plain carbon steel / Unlegierter Stahl	< 600	< 230	80	90	100
P2 Alloy Steel / Legierter Stahl	< 1200	< 350	70	80	90
P3 High alloy steel and tool steel / Hochlegierter Stahl und Werkzeugstahl	< 1400	< 380	40	50	60
M1 Aust. and Ferr. Stainless steel / Aust. und Ferr. rostfreie Stähle	< 680	< 220	30	40	50
M2 Mart. Stainless steel / Mart. rostfreie Stähle	< 820	< 240	30	40	50
K1 Grey cast iron / Grauguß	-	< 280	100	120	140
K2 Ductile cast iron / Sphäroguß	-	< 320	70	80	90
N1 Non-ferrous alloys / Nichteisenmetalle	< 250	< 110	-	-	-
N2 Aluminium alloys / Aluminiumlegierungen	< 530	< 130	-	-	-
S1 High temperature alloys Fe, Ni and Co based / Warmfeste Leg. Fe, Ni und Co	< 3300	< 350	30	40	50
S2 Titanium alloys; Alpha and Beta / Titan Legierungen Alpha und Beta	< 2100	< 400	-	-	-
H1 Hardened steel / Gehärtete Stähle	-	< 54 HRC	-	-	-
H2 Hardened steel / Gehärtete Stähle	-	52-60 HRC	-	-	-
H3 Hardened steel / Gehärtete Stähle	-	> 58 HRC	-	-	-
G1 Graphite / Graphit	-	-	-	-	-

Cutting conditions / Zerspanungswerte

Material Material	f Feed per revolution [mm] / Vorschub pro Umdrehung [mm]										
	Ø 0 - 2	Ø 2 - 2,5	Ø 2,5 - 3	Ø 3 - 4	Ø 4 - 5	Ø 5 - 6	Ø 6 - 8	Ø 8 - 10	Ø 10 - 12	Ø 12 - 16	Ø 16 - 20
P1	0,080	0,100	0,125	0,160	0,160	0,200	0,250	0,315	0,315	0,400	0,500
P2	0,063	0,080	0,100	0,125	0,125	0,160	0,200	0,250	0,250	0,315	0,400
P3	0,050	0,063	0,080	0,100	0,100	0,125	0,160	0,200	0,200	0,250	0,315
M1	0,040	0,050	0,063	0,080	0,080	0,100	0,125	0,160	0,160	0,200	0,250
M2	0,032	0,040	0,050	0,063	0,063	0,080	0,100	0,125	0,125	0,160	0,200
K1	0,125	0,160	0,160	0,200	0,250	0,315	0,315	0,400	0,500	0,630	0,630
K2	0,100	0,125	0,160	0,200	0,200	0,250	0,315	0,400	0,400	0,500	0,630
N1	0,100	0,125	0,160	0,200	0,200	0,250	0,315	0,400	0,400	0,500	0,630
N2	0,125	0,160	0,160	0,200	0,250	0,315	0,315	0,400	0,500	0,630	0,630
S1	0,040	0,050	0,063	0,080	0,080	0,100	0,125	0,160	0,160	0,200	0,250
S2	0,032	0,040	0,050	0,063	0,063	0,080	0,100	0,125	0,125	0,160	0,200
H1	0,032	0,040	0,050	0,063	0,063	0,080	0,100	0,125	0,125	0,160	0,200
H2	0,025	0,032	0,040	0,050	0,050	0,063	0,080	0,100	0,100	0,125	0,160
H3	-	-	-	-	-	-	-	-	-	-	-
G1	-	-	-	-	-	-	-	-	-	-	-

Solid carbide drill; 12xD; SCT norm; with internal coolant holes; TiAlN coated
 VHM Bohrer; 12xD; SCT Norm; mit Innenkühlung; TiAlN beschichtet

Specifications / Spezifikationen

DIN 6535 HA	DIN 6535 HE	Dc	Ds	Ls	Ln	Dn	Lt	r	z
BLDC212D030030SIK	-	3,0	6	50	-	-	90	-	2
BLDC212D031030SIK	-	3,1	6	50	-	-	90	-	2
BLDC212D032030SIK	-	3,2	6	50	-	-	90	-	2
BLDC212D033030SIK	-	3,3	6	50	-	-	90	-	2
BLDC212D034030SIK	-	3,4	6	50	-	-	90	-	2
BLDC212D035030SIK	-	3,5	6	50	-	-	90	-	2
BLDC212D036030SIK	-	3,6	6	50	-	-	90	-	2
BLDC212D037030SIK	-	3,7	6	50	-	-	90	-	2
BLDC212D038030SIK	-	3,8	6	64	-	-	102	-	2
BLDC212D039030SIK	-	3,9	6	64	-	-	102	-	2
BLDC212D040030SIK	-	4,0	6	64	-	-	102	-	2
BLDC212D041030SIK	-	4,1	6	64	-	-	102	-	2
BLDC212D042030SIK	-	4,2	6	64	-	-	102	-	2
BLDC212D043030SIK	-	4,3	6	64	-	-	102	-	2
BLDC212D044030SIK	-	4,4	6	64	-	-	102	-	2
BLDC212D045030SIK	-	4,5	6	64	-	-	102	-	2
BLDC212D046030SIK	-	4,6	6	64	-	-	102	-	2
BLDC212D047030SIK	-	4,7	6	64	-	-	102	-	2
BLDC212D048030SIK	-	4,8	6	78	-	-	116	-	2
BLDC212D049030SIK	-	4,9	6	78	-	-	116	-	2
BLDC212D050030SIK	-	5,0	6	78	-	-	116	-	2
BLDC212D051030SIK	-	5,1	6	78	-	-	116	-	2
BLDC212D052030SIK	-	5,2	6	78	-	-	116	-	2
BLDC212D053030SIK	-	5,3	6	78	-	-	116	-	2
BLDC212D054030SIK	-	5,4	6	78	-	-	116	-	2
BLDC212D055030SIK	-	5,5	6	78	-	-	116	-	2
BLDC212D056030SIK	-	5,6	6	78	-	-	116	-	2
BLDC212D057030SIK	-	5,7	6	78	-	-	116	-	2
BLDC212D058030SIK	-	5,8	6	78	-	-	116	-	2
BLDC212D059030SIK	-	5,9	6	78	-	-	116	-	2
BLDC212D060030SIK	-	6,0	6	78	-	-	116	-	2
BLDC212D061030SIK	-	6,1	8	108	-	-	146	-	2
BLDC212D062030SIK	-	6,2	8	108	-	-	146	-	2
BLDC212D063030SIK	-	6,3	8	108	-	-	146	-	2
BLDC212D064030SIK	-	6,4	8	108	-	-	146	-	2
BLDC212D065030SIK	-	6,5	8	108	-	-	146	-	2
BLDC212D066030SIK	-	6,6	8	108	-	-	146	-	2
BLDC212D067030SIK	-	6,7	8	108	-	-	146	-	2
BLDC212D068030SIK	-	6,8	8	108	-	-	146	-	2
BLDC212D069030SIK	-	6,9	8	108	-	-	146	-	2
BLDC212D070030SIK	-	7,0	8	108	-	-	146	-	2
BLDC212D071030SIK	-	7,1	8	108	-	-	146	-	2
BLDC212D072030SIK	-	7,2	8	108	-	-	146	-	2
BLDC212D073030SIK	-	7,3	8	108	-	-	146	-	2



Other dimensions on request / Andere Abmessungen auf Anfrage

Dimensions in mm / Maße in mm

Solid carbide drill; 12xD; SCT norm; with internal coolant holes; TiAlN coated
VHM Bohrer; 12xD; SCT Norm; mit Innenkühlung; TiAlN beschichtet

Workpiece material groups and cutting speed / Werkstoffgruppen und Schnittgeschwindigkeiten

Material Material	Tensile strength Zugfestigkeit Rm [N/mm ²]	Hardness Härte [HB/HRC]	Cutting speed Vc [m/min] Schnittgeschwindigkeiten		
			min	opt	max
P1 Plain carbon steel / Unlegierter Stahl	< 600	< 230	80	90	100
P2 Alloy Steel / Legierter Stahl	< 1200	< 350	70	80	90
P3 High alloy steel and tool steel / Hochlegierter Stahl und Werkzeugstahl	< 1400	< 380	40	50	60
M1 Aust. and Ferr. Stainless steel / Aust. und Ferr. rostfreie Stähle	< 680	< 220	30	40	50
M2 Mart. Stainless steel / Mart. rostfreie Stähle	< 820	< 240	30	40	50
K1 Grey cast iron / Grauguß	-	< 280	100	120	140
K2 Ductile cast iron / Sphäroguß	-	< 320	70	80	90
N1 Non-ferrous alloys / Nichteisenmetalle	< 250	< 110	-	-	-
N2 Aluminium alloys / Aluminiumlegierungen	< 530	< 130	-	-	-
S1 High temperature alloys Fe, Ni and Co based / Warmfeste Leg. Fe, Ni und Co	< 3300	< 350	30	40	50
S2 Titanium alloys; Alpha and Beta / Titan Legierungen Alpha und Beta	< 2100	< 400	-	-	-
H1 Hardened steel / Gehärtete Stähle	-	< 54 HRC	-	-	-
H2 Hardened steel / Gehärtete Stähle	-	52-60 HRC	-	-	-
H3 Hardened steel / Gehärtete Stähle	-	> 58 HRC	-	-	-
G1 Graphite / Graphit	-	-	-	-	-

Cutting conditions / Zerspanungswerte

Material Material	f Feed per revolution [mm] / Vorschub pro Umdrehung [mm]										
	Ø 0 - 2	Ø 2 - 2,5	Ø 2,5 - 3	Ø 3 - 4	Ø 4 - 5	Ø 5 - 6	Ø 6 - 8	Ø 8 - 10	Ø 10 - 12	Ø 12 - 16	Ø 16 - 20
P1	0,080	0,100	0,125	0,160	0,160	0,200	0,250	0,315	0,315	0,400	0,500
P2	0,063	0,080	0,100	0,125	0,125	0,160	0,200	0,250	0,250	0,315	0,400
P3	0,050	0,063	0,080	0,100	0,100	0,125	0,160	0,200	0,200	0,250	0,315
M1	0,040	0,050	0,063	0,080	0,080	0,100	0,125	0,160	0,160	0,200	0,250
M2	0,032	0,040	0,050	0,063	0,063	0,080	0,100	0,125	0,125	0,160	0,200
K1	0,125	0,160	0,160	0,200	0,250	0,315	0,315	0,400	0,500	0,630	0,630
K2	0,100	0,125	0,160	0,200	0,200	0,250	0,315	0,400	0,400	0,500	0,630
N1	0,100	0,125	0,160	0,200	0,200	0,250	0,315	0,400	0,400	0,500	0,630
N2	0,125	0,160	0,160	0,200	0,250	0,315	0,315	0,400	0,500	0,630	0,630
S1	0,040	0,050	0,063	0,080	0,080	0,100	0,125	0,160	0,160	0,200	0,250
S2	0,032	0,040	0,050	0,063	0,063	0,080	0,100	0,125	0,125	0,160	0,200
H1	0,032	0,040	0,050	0,063	0,063	0,080	0,100	0,125	0,125	0,160	0,200
H2	0,025	0,032	0,040	0,050	0,050	0,063	0,080	0,100	0,100	0,125	0,160
H3	-	-	-	-	-	-	-	-	-	-	-
G1	-	-	-	-	-	-	-	-	-	-	-

Solid carbide drill; 12xD; SCT norm; with internal coolant holes; TiAlN coated
 VHM Bohrer; 12xD; SCT Norm; mit Innenkühlung; TiAlN beschichtet

Specifications / Spezifikationen

DIN 6535 HA	DIN 6535 HE	Dc	Ds	Ls	Ln	Dn	Lt	r	z
BLDC212D074030SIK	-	7,4	8	108	-	-	146	-	2
BLDC212D075030SIK	-	7,5	8	108	-	-	146	-	2
BLDC212D076030SIK	-	7,6	8	108	-	-	146	-	2
BLDC212D077030SIK	-	7,7	8	108	-	-	146	-	2
BLDC212D078030SIK	-	7,8	8	108	-	-	146	-	2
BLDC212D079030SIK	-	7,9	8	108	-	-	146	-	2
BLDC212D080030SIK	-	8,0	8	108	-	-	146	-	2
BLDC212D081030SIK	-	8,1	10	120	-	-	162	-	2
BLDC212D082030SIK	-	8,2	10	120	-	-	162	-	2
BLDC212D083030SIK	-	8,3	10	120	-	-	162	-	2
BLDC212D084030SIK	-	8,4	10	120	-	-	162	-	2
BLDC212D085030SIK	-	8,5	10	120	-	-	162	-	2
BLDC212D086030SIK	-	8,6	10	120	-	-	162	-	2
BLDC212D087030SIK	-	8,7	10	120	-	-	162	-	2
BLDC212D088030SIK	-	8,8	10	120	-	-	162	-	2
BLDC212D089030SIK	-	8,9	10	120	-	-	162	-	2
BLDC212D090030SIK	-	9,0	10	120	-	-	162	-	2
BLDC212D091030SIK	-	9,1	10	120	-	-	162	-	2
BLDC212D092030SIK	-	9,2	10	120	-	-	162	-	2
BLDC212D093030SIK	-	9,3	10	120	-	-	162	-	2
BLDC212D094030SIK	-	9,4	10	120	-	-	162	-	2
BLDC212D095030SIK	-	9,5	10	120	-	-	162	-	2
BLDC212D096030SIK	-	9,6	10	120	-	-	162	-	2
BLDC212D097030SIK	-	9,7	10	120	-	-	162	-	2
BLDC212D098030SIK	-	9,8	10	120	-	-	162	-	2
BLDC212D099030SIK	-	9,9	10	120	-	-	162	-	2
BLDC212D100030SIK	-	10,0	10	120	-	-	162	-	2
BLDC212D101030SIK	-	10,1	12	156	-	-	204	-	2
BLDC212D102030SIK	-	10,2	12	156	-	-	204	-	2
BLDC212D103030SIK	-	10,3	12	156	-	-	204	-	2
BLDC212D105030SIK	-	10,5	12	156	-	-	204	-	2
BLDC212D106030SIK	-	10,6	12	156	-	-	204	-	2
BLDC212D107030SIK	-	10,7	12	156	-	-	204	-	2
BLDC212D108030SIK	-	10,8	12	156	-	-	204	-	2
BLDC212D110030SIK	-	11,0	12	156	-	-	204	-	2
BLDC212D115030SIK	-	11,5	12	156	-	-	204	-	2
BLDC212D120030SIK	-	12,0	12	156	-	-	204	-	2
BLDC212D123030SIK	-	12,3	14	182	-	-	230	-	2
BLDC212D125030SIK	-	12,5	14	182	-	-	230	-	2
BLDC212D127030SIK	-	12,7	14	182	-	-	230	-	2
BLDC212D130030SIK	-	13,0	14	182	-	-	230	-	2
BLDC212D135030SIK	-	13,5	14	182	-	-	230	-	2
BLDC212D140030SIK	-	14,0	14	182	-	-	230	-	2
BLDC212D145030SIK	-	14,5	16	208	-	-	260	-	2



Other dimensions on request / Andere Abmessungen auf Anfrage

Dimensions in mm / Maße in mm

Solid carbide drill; 12xD; SCT norm; with internal coolant holes; TiAlN coated
VHM Bohrer; 12xD; SCT Norm; mit Innenkühlung; TiAlN beschichtet

Workpiece material groups and cutting speed / Werkstoffgruppen und Schnittgeschwindigkeiten

Material Material	Tensile strength Zugfestigkeit Rm [N/mm ²]	Hardness Härte [HB/HRC]	Cutting speed Vc [m/min] Schnittgeschwindigkeiten		
			min	opt	max
P1 Plain carbon steel / Unlegierter Stahl	< 600	< 230	80	90	100
P2 Alloy Steel / Legierter Stahl	< 1200	< 350	70	80	90
P3 High alloy steel and tool steel / Hochlegierter Stahl und Werkzeugstahl	< 1400	< 380	40	50	60
M1 Aust. and Ferr. Stainless steel / Aust. und Ferr. rostfreie Stähle	< 680	< 220	30	40	50
M2 Mart. Stainless steel / Mart. rostfreie Stähle	< 820	< 240	30	40	50
K1 Grey cast iron / Grauguß	-	< 280	100	120	140
K2 Ductile cast iron / Sphäroguß	-	< 320	70	80	90
N1 Non-ferrous alloys / Nichteisenmetalle	< 250	< 110	-	-	-
N2 Aluminium alloys / Aluminiumlegierungen	< 530	< 130	-	-	-
S1 High temperature alloys Fe, Ni and Co based / Warmfeste Leg. Fe, Ni und Co	< 3300	< 350	30	40	50
S2 Titanium alloys; Alpha and Beta / Titan Legierungen Alpha und Beta	< 2100	< 400	-	-	-
H1 Hardened steel / Gehärtete Stähle	-	< 54 HRC	-	-	-
H2 Hardened steel / Gehärtete Stähle	-	52-60 HRC	-	-	-
H3 Hardened steel / Gehärtete Stähle	-	> 58 HRC	-	-	-
G1 Graphite / Graphit	-	-	-	-	-

Cutting conditions / Zerspanungswerte

Material Material	f Feed per revolution [mm] / Vorschub pro Umdrehung [mm]										
	Ø 0 - 2	Ø 2 - 2,5	Ø 2,5 - 3	Ø 3 - 4	Ø 4 - 5	Ø 5 - 6	Ø 6 - 8	Ø 8 - 10	Ø 10 - 12	Ø 12 - 16	Ø 16 - 20
P1	0,080	0,100	0,125	0,160	0,160	0,200	0,250	0,315	0,315	0,400	0,500
P2	0,063	0,080	0,100	0,125	0,125	0,160	0,200	0,250	0,250	0,315	0,400
P3	0,050	0,063	0,080	0,100	0,100	0,125	0,160	0,200	0,200	0,250	0,315
M1	0,040	0,050	0,063	0,080	0,080	0,100	0,125	0,160	0,160	0,200	0,250
M2	0,032	0,040	0,050	0,063	0,063	0,080	0,100	0,125	0,125	0,160	0,200
K1	0,125	0,160	0,160	0,200	0,250	0,315	0,315	0,400	0,500	0,630	0,630
K2	0,100	0,125	0,160	0,200	0,200	0,250	0,315	0,400	0,400	0,500	0,630
N1	0,100	0,125	0,160	0,200	0,200	0,250	0,315	0,400	0,400	0,500	0,630
N2	0,125	0,160	0,160	0,200	0,250	0,315	0,315	0,400	0,500	0,630	0,630
S1	0,040	0,050	0,063	0,080	0,080	0,100	0,125	0,160	0,160	0,200	0,250
S2	0,032	0,040	0,050	0,063	0,063	0,080	0,100	0,125	0,125	0,160	0,200
H1	0,032	0,040	0,050	0,063	0,063	0,080	0,100	0,125	0,125	0,160	0,200
H2	0,025	0,032	0,040	0,050	0,050	0,063	0,080	0,100	0,100	0,125	0,160
H3	-	-	-	-	-	-	-	-	-	-	-
G1	-	-	-	-	-	-	-	-	-	-	-

Solid carbide drill; 12xD; SCT norm; with internal coolant holes; TiAlN coated
 VHM Bohrer; 12xD; SCT Norm; mit Innenkühlung; TiAlN beschichtet

Specifications / Spezifikationen



DIN 6535 HA	DIN 6535 HE	Dc	Ds	Ls	Ln	Dn	Lt	r	z
BLDC212D150030SIK	-	15,0	16	208	-	-	260	-	2
BLDC212D155030SIK	-	15,5	16	208	-	-	260	-	2
BLDC212D160030SIK	-	16,0	16	208	-	-	260	-	2
BLDC212D165030SIK	-	16,5	18	234	-	-	285	-	2
BLDC212D170030SIK	-	17,0	18	234	-	-	285	-	2
BLDC212D175030SIK	-	17,5	18	234	-	-	285	-	2
BLDC212D180030SIK	-	18,0	18	234	-	-	285	-	2
BLDC212D185030SIK	-	18,5	20	258	-	-	310	-	2
BLDC212D190030SIK	-	19,0	20	258	-	-	310	-	2
BLDC212D195030SIK	-	19,5	20	258	-	-	310	-	2
BLDC212D200030SIK	-	20,0	20	258	-	-	310	-	2





BASICLINE
SOLID CARBIDE DRILLS[®]



Improving Quality Through Innovation

Product of Holland

UK D



PREMIUMLINE
SOLID CARBIDE DRILLS



- ▶ Stainless steel drills / Für Edelstahlbearbeitung
- ▶ Internal coolant / Innenkühlung
- ▶ TiAlN-based coated / TiAlN-basierte Schicht



Improving Quality Through Innovation

Product of Holland

Table of contents
Inhaltsverzeichnis

Solid carbide drill; 3xD; DIN6537K; with internal coolant holes; TiAlN-based coated
VHM Bohrer; 3xD; DIN6537K; mit Innenkühlung; TiAlN-basierte Schicht

4 - 9



Solid carbide drill; 5xD; DIN6537L; with internal coolant holes; TiAlN-based coated
VHM Bohrer; 5xD; DIN6537L; mit Innenkühlung; TiAlN-basierte Schicht

10 - 15



Solid carbide drill; 3xD; DIN6537K; with internal coolant holes; TiAlN-based coated

VHM Bohrer; 3xD; DIN6537K; mit Innenkühlung; TiAlN-basierte Schicht

Workpiece material groups and cutting speed / Werkstoffgruppen und Schnittgeschwindigkeiten

Material Material	Tensile strength Zugfestigkeit Rm [N/mm ²]	Hardness Härte [HB/HRC]	Cutting speed Vc [m/min] Schnittgeschwindigkeiten		
			min	opt	max
P1 Plain carbon steel / Unlegierter Stahl	< 600	< 230	-	-	-
P2 Alloy Steel / Legierter Stahl	< 1200	< 350	-	-	-
P3 High alloy steel and tool steel / Hochlegierter Stahl und Werkzeugstahl	< 1400	< 380	-	-	-
M1 Aust. and Ferr. Stainless steel / Aust. und Ferr. rostfreie Stähle	< 680	< 220	60	70	80
M2 Mart. Stainless steel / Mart. rostfreie Stähle	< 820	< 240	60	70	80
K1 Grey cast iron / Grauguß	-	< 280	-	-	-
K2 Ductile cast iron / Sphäroguß	-	< 320	-	-	-
N1 Non-ferrous alloys / Nichteisenmetalle	< 250	< 110	-	-	-
N2 Aluminium alloys / Aluminiumlegierungen	< 530	< 130	-	-	-
S1 High temperature alloys Fe, Ni and Co based / Warmfeste Leg. Fe, Ni und Co	< 3300	< 350	30	40	50
S2 Titanium alloys; Alpha and Beta / Titan Legierungen Alpha und Beta	< 2100	< 400	30	40	50
H1 Hardened steel / Gehärtete Stähle	-	< 54 HRC	-	-	-
H2 Hardened steel / Gehärtete Stähle	-	52-60 HRC	-	-	-
H3 Hardened steel / Gehärtete Stähle	-	> 58 HRC	-	-	-
G1 Graphite / Graphit	-	-	-	-	-

Cutting conditions / Zerspanungswerte

Material Material	f Feed per revolution [mm] / Vorschub pro Umdrehung [mm]										
	Ø 0 - 2	Ø 2 - 2,5	Ø 2,5 - 3	Ø 3 - 4	Ø 4 - 5	Ø 5 - 6	Ø 6 - 8	Ø 8 - 10	Ø 10 - 12	Ø 12 - 16	Ø 16 - 20
P1	0,080	0,100	0,125	0,160	0,160	0,200	0,250	0,315	0,315	0,400	0,500
P2	0,063	0,080	0,100	0,125	0,125	0,160	0,200	0,250	0,250	0,315	0,400
P3	0,050	0,063	0,080	0,100	0,100	0,125	0,160	0,200	0,200	0,250	0,315
M1	0,040	0,050	0,063	0,080	0,080	0,100	0,125	0,160	0,160	0,200	0,250
M2	0,032	0,040	0,050	0,063	0,063	0,080	0,100	0,125	0,125	0,160	0,200
K1	0,125	0,160	0,160	0,200	0,250	0,315	0,315	0,400	0,500	0,630	0,630
K2	0,100	0,125	0,160	0,200	0,200	0,250	0,315	0,400	0,400	0,500	0,630
N1	0,100	0,125	0,160	0,200	0,200	0,250	0,315	0,400	0,400	0,500	0,630
N2	0,125	0,160	0,160	0,200	0,250	0,315	0,315	0,400	0,500	0,630	0,630
S1	0,040	0,050	0,063	0,080	0,080	0,100	0,125	0,160	0,160	0,200	0,250
S2	0,032	0,040	0,050	0,063	0,063	0,080	0,100	0,125	0,125	0,160	0,200
H1	0,032	0,040	0,050	0,063	0,063	0,080	0,100	0,125	0,125	0,160	0,200
H2	0,025	0,032	0,040	0,050	0,050	0,063	0,080	0,100	0,100	0,125	0,160
H3	-	-	-	-	-	-	-	-	-	-	-
G1	-	-	-	-	-	-	-	-	-	-	-

Solid carbide drill; 3xD; DIN6537K; with internal coolant holes; TiAlN-based coated
 VHM Bohrer; 3xD; DIN6537K; mit Innenkühlung; TiAlN-basierte Schicht

Specifications / Spezifikationen

DIN 6535 HA	DIN 6535 HE	Dc	Ds	Ls	Ln	Dn	Lt	r	z
PLDIC203D030030IK	PLDIE203D030030IK	3,0	6	20	-	-	62	-	2
PLDIC203D031030IK	PLDIE203D031030IK	3,1	6	20	-	-	62	-	2
PLDIC203D032030IK	PLDIE203D032030IK	3,2	6	20	-	-	62	-	2
PLDIC203D033030IK	PLDIE203D033030IK	3,3	6	20	-	-	62	-	2
PLDIC203D034030IK	PLDIE203D034030IK	3,4	6	20	-	-	62	-	2
PLDIC203D035030IK	PLDIE203D035030IK	3,5	6	20	-	-	62	-	2
PLDIC203D036030IK	PLDIE203D036030IK	3,6	6	20	-	-	62	-	2
PLDIC203D037030IK	PLDIE203D037030IK	3,7	6	20	-	-	62	-	2
PLDIC203D038030IK	PLDIE203D038030IK	3,8	6	24	-	-	66	-	2
PLDIC203D039030IK	PLDIE203D039030IK	3,9	6	24	-	-	66	-	2
PLDIC203D040030IK	PLDIE203D040030IK	4,0	6	24	-	-	66	-	2
PLDIC203D041030IK	PLDIE203D041030IK	4,1	6	24	-	-	66	-	2
PLDIC203D042030IK	PLDIE203D042030IK	4,2	6	24	-	-	66	-	2
PLDIC203D043030IK	PLDIE203D043030IK	4,3	6	24	-	-	66	-	2
PLDIC203D044030IK	PLDIE203D044030IK	4,4	6	24	-	-	66	-	2
PLDIC203D045030IK	PLDIE203D045030IK	4,5	6	24	-	-	66	-	2
PLDIC203D046030IK	PLDIE203D046030IK	4,6	6	24	-	-	66	-	2
PLDIC203D047030IK	PLDIE203D047030IK	4,7	6	24	-	-	66	-	2
PLDIC203D048030IK	PLDIE203D048030IK	4,8	6	28	-	-	66	-	2
PLDIC203D049030IK	PLDIE203D049030IK	4,9	6	28	-	-	66	-	2
PLDIC203D050030IK	PLDIE203D050030IK	5,0	6	28	-	-	66	-	2
PLDIC203D051030IK	PLDIE203D051030IK	5,1	6	28	-	-	66	-	2
PLDIC203D052030IK	PLDIE203D052030IK	5,2	6	28	-	-	66	-	2
PLDIC203D053030IK	PLDIE203D053030IK	5,3	6	28	-	-	66	-	2
PLDIC203D054030IK	PLDIE203D054030IK	5,4	6	28	-	-	66	-	2
PLDIC203D055030IK	PLDIE203D055030IK	5,5	6	28	-	-	66	-	2
PLDIC203D056030IK	PLDIE203D056030IK	5,6	6	28	-	-	66	-	2
PLDIC203D057030IK	PLDIE203D057030IK	5,7	6	28	-	-	66	-	2
PLDIC203D058030IK	PLDIE203D058030IK	5,8	6	28	-	-	66	-	2
PLDIC203D059030IK	PLDIE203D059030IK	5,9	6	28	-	-	66	-	2
PLDIC203D060030IK	PLDIE203D060030IK	6,0	6	28	-	-	66	-	2
PLDIC203D061030IK	PLDIE203D061030IK	6,1	8	34	-	-	79	-	2
PLDIC203D062030IK	PLDIE203D062030IK	6,2	8	34	-	-	79	-	2
PLDIC203D063030IK	PLDIE203D063030IK	6,3	8	34	-	-	79	-	2
PLDIC203D064030IK	PLDIE203D064030IK	6,4	8	34	-	-	79	-	2
PLDIC203D065030IK	PLDIE203D065030IK	6,5	8	34	-	-	79	-	2
PLDIC203D066030IK	PLDIE203D066030IK	6,6	8	34	-	-	79	-	2
PLDIC203D067030IK	PLDIE203D067030IK	6,7	8	34	-	-	79	-	2
PLDIC203D068030IK	PLDIE203D068030IK	6,8	8	34	-	-	79	-	2
PLDIC203D069030IK	PLDIE203D069030IK	6,9	8	34	-	-	79	-	2
PLDIC203D070030IK	PLDIE203D070030IK	7,0	8	34	-	-	79	-	2
PLDIC203D071030IK	PLDIE203D071030IK	7,1	8	41	-	-	79	-	2
PLDIC203D072030IK	PLDIE203D072030IK	7,2	8	41	-	-	79	-	2
PLDIC203D073030IK	PLDIE203D073030IK	7,3	8	41	-	-	79	-	2



Other dimensions on request / Andere Abmessungen auf Anfrage

Dimensions in mm / Maße in mm

Solid carbide drill; 3xD; DIN6537K; with internal coolant holes; TiAlN-based coated

VHM Bohrer; 3xD; DIN6537K; mit Innenkühlung; TiAlN-basierte Schicht

Workpiece material groups and cutting speed / Werkstoffgruppen und Schnittgeschwindigkeiten

Material Material	Tensile strength Zugfestigkeit Rm [N/mm ²]	Hardness Härte [HB/HRC]	Cutting speed Vc [m/min] Schnittgeschwindigkeiten		
			min	opt	max
P1 Plain carbon steel / Unlegierter Stahl	< 600	< 230	-	-	-
P2 Alloy Steel / Legierter Stahl	< 1200	< 350	-	-	-
P3 High alloy steel and tool steel / Hochlegierter Stahl und Werkzeugstahl	< 1400	< 380	-	-	-
M1 Aust. and Ferr. Stainless steel / Aust. und Ferr. rostfreie Stähle	< 680	< 220	60	70	80
M2 Mart. Stainless steel / Mart. rostfreie Stähle	< 820	< 240	60	70	80
K1 Grey cast iron / Grauguß	-	< 280	-	-	-
K2 Ductile cast iron / Sphäroguß	-	< 320	-	-	-
N1 Non-ferrous alloys / Nichteisenmetalle	< 250	< 110	-	-	-
N2 Aluminium alloys / Aluminiumlegierungen	< 530	< 130	-	-	-
S1 High temperature alloys Fe, Ni and Co based / Warmfeste Leg. Fe, Ni und Co	< 3300	< 350	30	40	50
S2 Titanium alloys; Alpha and Beta / Titan Legierungen Alpha und Beta	< 2100	< 400	30	40	50
H1 Hardened steel / Gehärtete Stähle	-	< 54 HRC	-	-	-
H2 Hardened steel / Gehärtete Stähle	-	52-60 HRC	-	-	-
H3 Hardened steel / Gehärtete Stähle	-	> 58 HRC	-	-	-
G1 Graphite / Graphit	-	-	-	-	-

Cutting conditions / Zerspanungswerte

Material Material	f Feed per revolution [mm] / Vorschub pro Umdrehung [mm]										
	Ø 0 - 2	Ø 2 - 2,5	Ø 2,5 - 3	Ø 3 - 4	Ø 4 - 5	Ø 5 - 6	Ø 6 - 8	Ø 8 - 10	Ø 10 - 12	Ø 12 - 16	Ø 16 - 20
P1	0,080	0,100	0,125	0,160	0,160	0,200	0,250	0,315	0,315	0,400	0,500
P2	0,063	0,080	0,100	0,125	0,125	0,160	0,200	0,250	0,250	0,315	0,400
P3	0,050	0,063	0,080	0,100	0,100	0,125	0,160	0,200	0,200	0,250	0,315
M1	0,040	0,050	0,063	0,080	0,080	0,100	0,125	0,160	0,160	0,200	0,250
M2	0,032	0,040	0,050	0,063	0,063	0,080	0,100	0,125	0,125	0,160	0,200
K1	0,125	0,160	0,160	0,200	0,250	0,315	0,315	0,400	0,500	0,630	0,630
K2	0,100	0,125	0,160	0,200	0,200	0,250	0,315	0,400	0,400	0,500	0,630
N1	0,100	0,125	0,160	0,200	0,200	0,250	0,315	0,400	0,400	0,500	0,630
N2	0,125	0,160	0,160	0,200	0,250	0,315	0,315	0,400	0,500	0,630	0,630
S1	0,040	0,050	0,063	0,080	0,080	0,100	0,125	0,160	0,160	0,200	0,250
S2	0,032	0,040	0,050	0,063	0,063	0,080	0,100	0,125	0,125	0,160	0,200
H1	0,032	0,040	0,050	0,063	0,063	0,080	0,100	0,125	0,125	0,160	0,200
H2	0,025	0,032	0,040	0,050	0,050	0,063	0,080	0,100	0,100	0,125	0,160
H3	-	-	-	-	-	-	-	-	-	-	-
G1	-	-	-	-	-	-	-	-	-	-	-

Solid carbide drill; 3xD; DIN6537K; with internal coolant holes; TiAlN-based coated
 VHM Bohrer; 3xD; DIN6537K; mit Innenkühlung; TiAlN-basierte Schicht

Specifications / Spezifikationen

DIN 6535 HA	DIN 6535 HE	Dc	Ds	Ls	Ln	Dn	Lt	r	z
PLDIC203D074030IK	PLDIE203D074030IK	7,4	8	41	-	-	79	-	2
PLDIC203D075030IK	PLDIE203D075030IK	7,5	8	41	-	-	79	-	2
PLDIC203D076030IK	PLDIE203D076030IK	7,6	8	41	-	-	79	-	2
PLDIC203D077030IK	PLDIE203D077030IK	7,7	8	41	-	-	79	-	2
PLDIC203D078030IK	PLDIE203D078030IK	7,8	8	41	-	-	79	-	2
PLDIC203D079030IK	PLDIE203D079030IK	7,9	8	41	-	-	79	-	2
PLDIC203D080030IK	PLDIE203D080030IK	8,0	8	41	-	-	79	-	2
PLDIC203D081030IK	PLDIE203D081030IK	8,1	10	47	-	-	89	-	2
PLDIC203D082030IK	PLDIE203D082030IK	8,2	10	47	-	-	89	-	2
PLDIC203D083030IK	PLDIE203D083030IK	8,3	10	47	-	-	89	-	2
PLDIC203D084030IK	PLDIE203D084030IK	8,4	10	47	-	-	89	-	2
PLDIC203D085030IK	PLDIE203D085030IK	8,5	10	47	-	-	89	-	2
PLDIC203D086030IK	PLDIE203D086030IK	8,6	10	47	-	-	89	-	2
PLDIC203D087030IK	PLDIE203D087030IK	8,7	10	47	-	-	89	-	2
PLDIC203D088030IK	PLDIE203D088030IK	8,8	10	47	-	-	89	-	2
PLDIC203D089030IK	PLDIE203D089030IK	8,9	10	47	-	-	89	-	2
PLDIC203D090030IK	PLDIE203D090030IK	9,0	10	47	-	-	89	-	2
PLDIC203D091030IK	PLDIE203D091030IK	9,1	10	55	-	-	89	-	2
PLDIC203D092030IK	PLDIE203D092030IK	9,2	10	55	-	-	89	-	2
PLDIC203D093030IK	PLDIE203D093030IK	9,3	10	55	-	-	89	-	2
PLDIC203D094030IK	PLDIE203D094030IK	9,4	10	55	-	-	89	-	2
PLDIC203D095030IK	PLDIE203D095030IK	9,5	10	55	-	-	89	-	2
PLDIC203D096030IK	PLDIE203D096030IK	9,6	10	55	-	-	89	-	2
PLDIC203D097030IK	PLDIE203D097030IK	9,7	10	55	-	-	89	-	2
PLDIC203D098030IK	PLDIE203D098030IK	9,8	10	55	-	-	89	-	2
PLDIC203D099030IK	PLDIE203D099030IK	9,9	10	55	-	-	89	-	2
PLDIC203D100030IK	PLDIE203D100030IK	10,0	10	55	-	-	89	-	2
PLDIC203D101030IK	PLDIE203D101030IK	10,1	12	55	-	-	102	-	2
PLDIC203D102030IK	PLDIE203D102030IK	10,2	12	55	-	-	102	-	2
PLDIC203D103030IK	PLDIE203D103030IK	10,3	12	55	-	-	102	-	2
PLDIC203D104030IK	PLDIE203D104030IK	10,4	12	55	-	-	102	-	2
PLDIC203D105030IK	PLDIE203D105030IK	10,5	12	55	-	-	102	-	2
PLDIC203D106030IK	PLDIE203D106030IK	10,6	12	55	-	-	102	-	2
PLDIC203D107030IK	PLDIE203D107030IK	10,7	12	55	-	-	102	-	2
PLDIC203D108030IK	PLDIE203D108030IK	10,8	12	55	-	-	102	-	2
PLDIC203D109030IK	PLDIE203D109030IK	10,9	12	55	-	-	102	-	2
PLDIC203D110030IK	PLDIE203D110030IK	11,0	12	55	-	-	102	-	2
PLDIC203D111030IK	PLDIE203D111030IK	11,1	12	55	-	-	102	-	2
PLDIC203D112030IK	PLDIE203D112030IK	11,2	12	55	-	-	102	-	2
PLDIC203D113030IK	PLDIE203D113030IK	11,3	12	55	-	-	102	-	2
PLDIC203D114030IK	PLDIE203D114030IK	11,4	12	55	-	-	102	-	2
PLDIC203D115030IK	PLDIE203D115030IK	11,5	12	55	-	-	102	-	2
PLDIC203D116030IK	PLDIE203D116030IK	11,6	12	55	-	-	102	-	2
PLDIC203D117030IK	PLDIE203D117030IK	11,7	12	55	-	-	102	-	2



Other dimensions on request / Andere Abmessungen auf Anfrage

Dimensions in mm / Maße in mm

Solid carbide drill; 3xD; DIN6537K; with internal coolant holes; TiAlN-based coated

VHM Bohrer; 3xD; DIN6537K; mit Innenkühlung; TiAlN-basierte Schicht

Workpiece material groups and cutting speed / Werkstoffgruppen und Schnittgeschwindigkeiten

Material Material	Tensile strength Zugfestigkeit Rm [N/mm ²]	Hardness Härte [HB/HRC]	Cutting speed Vc [m/min] Schnittgeschwindigkeiten		
			min	opt	max
P1 Plain carbon steel / Unlegierter Stahl	< 600	< 230	-	-	-
P2 Alloy Steel / Legierter Stahl	< 1200	< 350	-	-	-
P3 High alloy steel and tool steel / Hochlegierter Stahl und Werkzeugstahl	< 1400	< 380	-	-	-
M1 Aust. and Ferr. Stainless steel / Aust. und Ferr. rostfreie Stähle	< 680	< 220	60	70	80
M2 Mart. Stainless steel / Mart. rostfreie Stähle	< 820	< 240	60	70	80
K1 Grey cast iron / Grauguß	-	< 280	-	-	-
K2 Ductile cast iron / Sphäroguß	-	< 320	-	-	-
N1 Non-ferrous alloys / Nichteisenmetalle	< 250	< 110	-	-	-
N2 Aluminium alloys / Aluminiumlegierungen	< 530	< 130	-	-	-
S1 High temperature alloys Fe, Ni and Co based / Warmfeste Leg. Fe, Ni und Co	< 3300	< 350	30	40	50
S2 Titanium alloys; Alpha and Beta / Titan Legierungen Alpha und Beta	< 2100	< 400	30	40	50
H1 Hardened steel / Gehärtete Stähle	-	< 54 HRC	-	-	-
H2 Hardened steel / Gehärtete Stähle	-	52-60 HRC	-	-	-
H3 Hardened steel / Gehärtete Stähle	-	> 58 HRC	-	-	-
G1 Graphite / Graphit	-	-	-	-	-

Cutting conditions / Zerspanungswerte

Material Material	f Feed per revolution [mm] / Vorschub pro Umdrehung [mm]										
	Ø 0 - 2	Ø 2 - 2,5	Ø 2,5 - 3	Ø 3 - 4	Ø 4 - 5	Ø 5 - 6	Ø 6 - 8	Ø 8 - 10	Ø 10 - 12	Ø 12 - 16	Ø 16 - 20
P1	0,080	0,100	0,125	0,160	0,160	0,200	0,250	0,315	0,315	0,400	0,500
P2	0,063	0,080	0,100	0,125	0,125	0,160	0,200	0,250	0,250	0,315	0,400
P3	0,050	0,063	0,080	0,100	0,100	0,125	0,160	0,200	0,200	0,250	0,315
M1	0,040	0,050	0,063	0,080	0,080	0,100	0,125	0,160	0,160	0,200	0,250
M2	0,032	0,040	0,050	0,063	0,063	0,080	0,100	0,125	0,125	0,160	0,200
K1	0,125	0,160	0,160	0,200	0,250	0,315	0,315	0,400	0,500	0,630	0,630
K2	0,100	0,125	0,160	0,200	0,200	0,250	0,315	0,400	0,400	0,500	0,630
N1	0,100	0,125	0,160	0,200	0,200	0,250	0,315	0,400	0,400	0,500	0,630
N2	0,125	0,160	0,160	0,200	0,250	0,315	0,315	0,400	0,500	0,630	0,630
S1	0,040	0,050	0,063	0,080	0,080	0,100	0,125	0,160	0,160	0,200	0,250
S2	0,032	0,040	0,050	0,063	0,063	0,080	0,100	0,125	0,125	0,160	0,200
H1	0,032	0,040	0,050	0,063	0,063	0,080	0,100	0,125	0,125	0,160	0,200
H2	0,025	0,032	0,040	0,050	0,050	0,063	0,080	0,100	0,100	0,125	0,160
H3	-	-	-	-	-	-	-	-	-	-	-
G1	-	-	-	-	-	-	-	-	-	-	-

Solid carbide drill; 3xD; DIN6537K; with internal coolant holes; TiAlN-based coated
 VHM Bohrer; 3xD; DIN6537K; mit Innenkühlung; TiAlN-basierte Schicht

Specifications / Spezifikationen

DIN 6535 HA	DIN 6535 HE	Dc	Ds	Ls	Ln	Dn	Lt	r	z
PLDIC203D118030IK	PLDIE203D118030IK	11,8	12	55	-	-	102	-	2
PLDIC203D119030IK	PLDIE203D119030IK	11,9	12	55	-	-	102	-	2
PLDIC203D120030IK	PLDIE203D120030IK	12,0	12	55	-	-	102	-	2
PLDIC203D122030IK	PLDIE203D122030IK	12,2	14	60	-	-	107	-	2
PLDIC203D125030IK	PLDIE203D125030IK	12,5	14	60	-	-	107	-	2
PLDIC203D127030IK	PLDIE203D127030IK	12,7	14	60	-	-	107	-	2
PLDIC203D128030IK	PLDIE203D128030IK	12,8	14	60	-	-	107	-	2
PLDIC203D130030IK	PLDIE203D130030IK	13,0	14	60	-	-	107	-	2
PLDIC203D133030IK	PLDIE203D133030IK	13,3	14	60	-	-	107	-	2
PLDIC203D135030IK	PLDIE203D135030IK	13,5	14	60	-	-	107	-	2
PLDIC203D137030IK	PLDIE203D137030IK	13,7	14	60	-	-	107	-	2
PLDIC203D140030IK	PLDIE203D140030IK	14,0	14	60	-	-	107	-	2
PLDIC203D142030IK	PLDIE203D142030IK	14,2	16	65	-	-	115	-	2
PLDIC203D143030IK	PLDIE203D143030IK	14,3	16	65	-	-	115	-	2
PLDIC203D145030IK	PLDIE203D145030IK	14,5	16	65	-	-	115	-	2
PLDIC203D147030IK	PLDIE203D147030IK	14,7	16	65	-	-	115	-	2
PLDIC203D150030IK	PLDIE203D150030IK	15,0	16	65	-	-	115	-	2
PLDIC203D152030IK	PLDIE203D152030IK	15,2	16	65	-	-	115	-	2
PLDIC203D153030IK	PLDIE203D153030IK	15,3	16	65	-	-	115	-	2
PLDIC203D155030IK	PLDIE203D155030IK	15,5	16	65	-	-	115	-	2
PLDIC203D157030IK	PLDIE203D157030IK	15,7	16	65	-	-	115	-	2
PLDIC203D160030IK	PLDIE203D160030IK	16,0	16	65	-	-	115	-	2
PLDIC203D163030IK	PLDIE203D163030IK	16,3	18	73	-	-	123	-	2
PLDIC203D165030IK	PLDIE203D165030IK	16,5	18	73	-	-	123	-	2
PLDIC203D169030IK	PLDIE203D169030IK	16,9	18	73	-	-	123	-	2
PLDIC203D170030IK	PLDIE203D170030IK	17,0	18	73	-	-	123	-	2
PLDIC203D173030IK	PLDIE203D173030IK	17,3	18	73	-	-	123	-	2
PLDIC203D175030IK	PLDIE203D175030IK	17,5	18	73	-	-	123	-	2
PLDIC203D180030IK	PLDIE203D180030IK	18,0	18	73	-	-	123	-	2
PLDIC203D185030IK	PLDIE203D185030IK	18,5	20	79	-	-	131	-	2
PLDIC203D189030IK	PLDIE203D189030IK	18,9	20	79	-	-	131	-	2
PLDIC203D190030IK	PLDIE203D190030IK	19,0	20	79	-	-	131	-	2
PLDIC203D193030IK	PLDIE203D193030IK	19,3	20	79	-	-	131	-	2
PLDIC203D195030IK	PLDIE203D195030IK	19,5	20	79	-	-	131	-	2
PLDIC203D200030IK	PLDIE203D200030IK	20,0	20	79	-	-	131	-	2



Solid carbide drill; 5xD; DIN6537L; with internal coolant holes; TiAlN-based coated

VHM Bohrer; 5xD; DIN6537L; mit Innenkühlung; TiAlN-basierte Schicht

Workpiece material groups and cutting speed / Werkstoffgruppen und Schnittgeschwindigkeiten

Material Material	Tensile strength Zugfestigkeit Rm [N/mm ²]	Hardness Härte [HB/HRC]	Cutting speed Vc [m/min] Schnittgeschwindigkeiten		
			min	opt	max
P1 Plain carbon steel / Unlegierter Stahl	< 600	< 230	-	-	-
P2 Alloy Steel / Legierter Stahl	< 1200	< 350	-	-	-
P3 High alloy steel and tool steel / Hochlegierter Stahl und Werkzeugstahl	< 1400	< 380	-	-	-
M1 Aust. and Ferr. Stainless steel / Aust. und Ferr. rostfreie Stähle	< 680	< 220	60	70	80
M2 Mart. Stainless steel / Mart. rostfreie Stähle	< 820	< 240	60	70	80
K1 Grey cast iron / Grauguß	-	< 280	-	-	-
K2 Ductile cast iron / Sphäroguß	-	< 320	-	-	-
N1 Non-ferrous alloys / Nichteisenmetalle	< 250	< 110	-	-	-
N2 Aluminium alloys / Aluminiumlegierungen	< 530	< 130	-	-	-
S1 High temperature alloys Fe, Ni and Co based / Warmfeste Leg. Fe, Ni und Co	< 3300	< 350	30	40	50
S2 Titanium alloys; Alpha and Beta / Titan Legierungen Alpha und Beta	< 2100	< 400	30	40	50
H1 Hardened steel / Gehärtete Stähle	-	< 54 HRC	-	-	-
H2 Hardened steel / Gehärtete Stähle	-	52-60 HRC	-	-	-
H3 Hardened steel / Gehärtete Stähle	-	> 58 HRC	-	-	-
G1 Graphite / Graphit	-	-	-	-	-

Cutting conditions / Zerspanungswerte

Material Material	f Feed per revolution [mm] / Vorschub pro Umdrehung [mm]										
	Ø 0 - 2	Ø 2 - 2,5	Ø 2,5 - 3	Ø 3 - 4	Ø 4 - 5	Ø 5 - 6	Ø 6 - 8	Ø 8 - 10	Ø 10 - 12	Ø 12 - 16	Ø 16 - 20
P1	0,080	0,100	0,125	0,160	0,160	0,200	0,250	0,315	0,315	0,400	0,500
P2	0,063	0,080	0,100	0,125	0,125	0,160	0,200	0,250	0,250	0,315	0,400
P3	0,050	0,063	0,080	0,100	0,100	0,125	0,160	0,200	0,200	0,250	0,315
M1	0,040	0,050	0,063	0,080	0,080	0,100	0,125	0,160	0,160	0,200	0,250
M2	0,032	0,040	0,050	0,063	0,063	0,080	0,100	0,125	0,125	0,160	0,200
K1	0,125	0,160	0,160	0,200	0,250	0,315	0,315	0,400	0,500	0,630	0,630
K2	0,100	0,125	0,160	0,200	0,200	0,250	0,315	0,400	0,400	0,500	0,630
N1	0,100	0,125	0,160	0,200	0,200	0,250	0,315	0,400	0,400	0,500	0,630
N2	0,125	0,160	0,160	0,200	0,250	0,315	0,315	0,400	0,500	0,630	0,630
S1	0,040	0,050	0,063	0,080	0,080	0,100	0,125	0,160	0,160	0,200	0,250
S2	0,032	0,040	0,050	0,063	0,063	0,080	0,100	0,125	0,125	0,160	0,200
H1	0,032	0,040	0,050	0,063	0,063	0,080	0,100	0,125	0,125	0,160	0,200
H2	0,025	0,032	0,040	0,050	0,050	0,063	0,080	0,100	0,100	0,125	0,160
H3	-	-	-	-	-	-	-	-	-	-	-
G1	-	-	-	-	-	-	-	-	-	-	-

Solid carbide drill; 5xD; DIN6537L; with internal coolant holes; TiAlN-based coated
 VHM Bohrer; 5xD; DIN6537L; mit Innenkühlung; TiAlN-basierte Schicht

Specifications / Spezifikationen

DIN 6535 HA	DIN 6535 HE	Dc	Ds	Ls	Ln	Dn	Lt	r	z
PLDIC205D030030IK	PLDIE205D030030IK	3,0	6	28	-	-	66	-	2
PLDIC205D031030IK	PLDIE205D031030IK	3,1	6	28	-	-	66	-	2
PLDIC205D032030IK	PLDIE205D032030IK	3,2	6	28	-	-	66	-	2
PLDIC205D033030IK	PLDIE205D033030IK	3,3	6	28	-	-	66	-	2
PLDIC205D034030IK	PLDIE205D034030IK	3,4	6	28	-	-	66	-	2
PLDIC205D035030IK	PLDIE205D035030IK	3,5	6	28	-	-	66	-	2
PLDIC205D036030IK	PLDIE205D036030IK	3,6	6	28	-	-	66	-	2
PLDIC205D037030IK	PLDIE205D037030IK	3,7	6	28	-	-	66	-	2
PLDIC205D038030IK	PLDIE205D038030IK	3,8	6	36	-	-	74	-	2
PLDIC205D039030IK	PLDIE205D039030IK	3,9	6	36	-	-	74	-	2
PLDIC205D040030IK	PLDIE205D040030IK	4,0	6	36	-	-	74	-	2
PLDIC205D041030IK	PLDIE205D041030IK	4,1	6	36	-	-	74	-	2
PLDIC205D042030IK	PLDIE205D042030IK	4,2	6	36	-	-	74	-	2
PLDIC205D043030IK	PLDIE205D043030IK	4,3	6	36	-	-	74	-	2
PLDIC205D044030IK	PLDIE205D044030IK	4,4	6	36	-	-	74	-	2
PLDIC205D045030IK	PLDIE205D045030IK	4,5	6	36	-	-	74	-	2
PLDIC205D046030IK	PLDIE205D046030IK	4,6	6	36	-	-	74	-	2
PLDIC205D047030IK	PLDIE205D047030IK	4,7	6	36	-	-	74	-	2
PLDIC205D048030IK	PLDIE205D048030IK	4,8	6	44	-	-	82	-	2
PLDIC205D049030IK	PLDIE205D049030IK	4,9	6	44	-	-	82	-	2
PLDIC205D050030IK	PLDIE205D050030IK	5,0	6	44	-	-	82	-	2
PLDIC205D051030IK	PLDIE205D051030IK	5,1	6	44	-	-	82	-	2
PLDIC205D052030IK	PLDIE205D052030IK	5,2	6	44	-	-	82	-	2
PLDIC205D053030IK	PLDIE205D053030IK	5,3	6	44	-	-	82	-	2
PLDIC205D054030IK	PLDIE205D054030IK	5,4	6	44	-	-	82	-	2
PLDIC205D056030IK	PLDIE205D056030IK	5,6	6	44	-	-	82	-	2
PLDIC205D058030IK	PLDIE205D058030IK	5,8	6	44	-	-	82	-	2
PLDIC205D059030IK	PLDIE205D059030IK	5,9	6	44	-	-	82	-	2
PLDIC205D060030IK	PLDIE205D060030IK	6,0	6	44	-	-	82	-	2
PLDIC205D061030IK	PLDIE205D061030IK	6,1	8	53	-	-	91	-	2
PLDIC205D062030IK	PLDIE205D062030IK	6,2	8	53	-	-	91	-	2
PLDIC205D063030IK	PLDIE205D063030IK	6,3	8	53	-	-	91	-	2
PLDIC205D064030IK	PLDIE205D064030IK	6,4	8	53	-	-	91	-	2
PLDIC205D065030IK	PLDIE205D065030IK	6,5	8	53	-	-	91	-	2
PLDIC205D066030IK	PLDIE205D066030IK	6,6	8	53	-	-	91	-	2
PLDIC205D067030IK	PLDIE205D067030IK	6,7	8	53	-	-	91	-	2
PLDIC205D068030IK	PLDIE205D068030IK	6,8	8	53	-	-	91	-	2
PLDIC205D069030IK	PLDIE205D069030IK	6,9	8	53	-	-	91	-	2
PLDIC205D070030IK	PLDIE205D070030IK	7,0	8	53	-	-	91	-	2
PLDIC205D071030IK	PLDIE205D071030IK	7,1	8	53	-	-	91	-	2
PLDIC205D072030IK	PLDIE205D072030IK	7,2	8	53	-	-	91	-	2
PLDIC205D073030IK	PLDIE205D073030IK	7,3	8	53	-	-	91	-	2
PLDIC205D074030IK	PLDIE205D074030IK	7,4	8	53	-	-	91	-	2
PLDIC205D075030IK	PLDIE205D075030IK	7,5	8	53	-	-	91	-	2



Other dimensions on request / Andere Abmessungen auf Anfrage

Dimensions in mm / Maße in mm

Solid carbide drill; 5xD; DIN6537L; with internal coolant holes; TiAlN-based coated

VHM Bohrer; 5xD; DIN6537L; mit Innenkühlung; TiAlN-basierte Schicht

Workpiece material groups and cutting speed / Werkstoffgruppen und Schnittgeschwindigkeiten

Material Material	Tensile strength Zugfestigkeit Rm [N/mm ²]	Hardness Härte [HB/HRC]	Cutting speed Vc [m/min] Schnittgeschwindigkeiten		
			min	opt	max
P1 Plain carbon steel / Unlegierter Stahl	< 600	< 230	-	-	-
P2 Alloy Steel / Legierter Stahl	< 1200	< 350	-	-	-
P3 High alloy steel and tool steel / Hochlegierter Stahl und Werkzeugstahl	< 1400	< 380	-	-	-
M1 Aust. and Ferr. Stainless steel / Aust. und Ferr. rostfreie Stähle	< 680	< 220	60	70	80
M2 Mart. Stainless steel / Mart. rostfreie Stähle	< 820	< 240	60	70	80
K1 Grey cast iron / Grauguß	-	< 280	-	-	-
K2 Ductile cast iron / Sphäroguß	-	< 320	-	-	-
N1 Non-ferrous alloys / Nichteisenmetalle	< 250	< 110	-	-	-
N2 Aluminium alloys / Aluminiumlegierungen	< 530	< 130	-	-	-
S1 High temperature alloys Fe, Ni and Co based / Warmfeste Leg. Fe, Ni und Co	< 3300	< 350	30	40	50
S2 Titanium alloys; Alpha and Beta / Titan Legierungen Alpha und Beta	< 2100	< 400	30	40	50
H1 Hardened steel / Gehärtete Stähle	-	< 54 HRC	-	-	-
H2 Hardened steel / Gehärtete Stähle	-	52-60 HRC	-	-	-
H3 Hardened steel / Gehärtete Stähle	-	> 58 HRC	-	-	-
G1 Graphite / Graphit	-	-	-	-	-

Cutting conditions / Zerspanungswerte

Material Material	f Feed per revolution [mm] / Vorschub pro Umdrehung [mm]										
	Ø 0 - 2	Ø 2 - 2,5	Ø 2,5 - 3	Ø 3 - 4	Ø 4 - 5	Ø 5 - 6	Ø 6 - 8	Ø 8 - 10	Ø 10 - 12	Ø 12 - 16	Ø 16 - 20
P1	0,080	0,100	0,125	0,160	0,160	0,200	0,250	0,315	0,315	0,400	0,500
P2	0,063	0,080	0,100	0,125	0,125	0,160	0,200	0,250	0,250	0,315	0,400
P3	0,050	0,063	0,080	0,100	0,100	0,125	0,160	0,200	0,200	0,250	0,315
M1	0,040	0,050	0,063	0,080	0,080	0,100	0,125	0,160	0,160	0,200	0,250
M2	0,032	0,040	0,050	0,063	0,063	0,080	0,100	0,125	0,125	0,160	0,200
K1	0,125	0,160	0,160	0,200	0,250	0,315	0,315	0,400	0,500	0,630	0,630
K2	0,100	0,125	0,160	0,200	0,200	0,250	0,315	0,400	0,400	0,500	0,630
N1	0,100	0,125	0,160	0,200	0,200	0,250	0,315	0,400	0,400	0,500	0,630
N2	0,125	0,160	0,160	0,200	0,250	0,315	0,315	0,400	0,500	0,630	0,630
S1	0,040	0,050	0,063	0,080	0,080	0,100	0,125	0,160	0,160	0,200	0,250
S2	0,032	0,040	0,050	0,063	0,063	0,080	0,100	0,125	0,125	0,160	0,200
H1	0,032	0,040	0,050	0,063	0,063	0,080	0,100	0,125	0,125	0,160	0,200
H2	0,025	0,032	0,040	0,050	0,050	0,063	0,080	0,100	0,100	0,125	0,160
H3	-	-	-	-	-	-	-	-	-	-	-
G1	-	-	-	-	-	-	-	-	-	-	-

Solid carbide drill; 5xD; DIN6537L; with internal coolant holes; TiAlN-based coated
 VHM Bohrer; 5xD; DIN6537L; mit Innenkühlung; TiAlN-basierte Schicht

Specifications / Spezifikationen

DIN 6535 HA	DIN 6535 HE	Dc	Ds	Ls	Ln	Dn	Lt	r	z
PLDIC205D076030IK	PLDIE205D076030IK	7,6	8	53	-	-	91	-	2
PLDIC205D077030IK	PLDIE205D077030IK	7,7	8	53	-	-	91	-	2
PLDIC205D078030IK	PLDIE205D078030IK	7,8	8	53	-	-	91	-	2
PLDIC205D079030IK	PLDIE205D079030IK	7,9	8	53	-	-	91	-	2
PLDIC205D080030IK	PLDIE205D080030IK	8,0	8	53	-	-	91	-	2
PLDIC205D081030IK	PLDIE205D081030IK	8,1	10	61	-	-	103	-	2
PLDIC205D082030IK	PLDIE205D082030IK	8,2	10	61	-	-	103	-	2
PLDIC205D083030IK	PLDIE205D083030IK	8,3	10	61	-	-	103	-	2
PLDIC205D084030IK	PLDIE205D084030IK	8,4	10	61	-	-	103	-	2
PLDIC205D085030IK	PLDIE205D085030IK	8,5	10	61	-	-	103	-	2
PLDIC205D086030IK	PLDIE205D086030IK	8,6	10	61	-	-	103	-	2
PLDIC205D087030IK	PLDIE205D087030IK	8,7	10	61	-	-	103	-	2
PLDIC205D088030IK	PLDIE205D088030IK	8,8	10	61	-	-	103	-	2
PLDIC205D089030IK	PLDIE205D089030IK	8,9	10	61	-	-	103	-	2
PLDIC205D090030IK	PLDIE205D090030IK	9,0	10	61	-	-	103	-	2
PLDIC205D091030IK	PLDIE205D091030IK	9,1	10	61	-	-	103	-	2
PLDIC205D092030IK	PLDIE205D092030IK	9,2	10	61	-	-	103	-	2
PLDIC205D093030IK	PLDIE205D093030IK	9,3	10	61	-	-	103	-	2
PLDIC205D094030IK	PLDIE205D094030IK	9,4	10	61	-	-	103	-	2
PLDIC205D095030IK	PLDIE205D095030IK	9,5	10	61	-	-	103	-	2
PLDIC205D096030IK	PLDIE205D096030IK	9,6	10	61	-	-	103	-	2
PLDIC205D097030IK	PLDIE205D097030IK	9,7	10	61	-	-	103	-	2
PLDIC205D098030IK	PLDIE205D098030IK	9,8	10	61	-	-	103	-	2
PLDIC205D099030IK	PLDIE205D099030IK	9,9	10	61	-	-	103	-	2
PLDIC205D100030IK	PLDIE205D100030IK	10,0	10	61	-	-	103	-	2
PLDIC205D101030IK	PLDIE205D101030IK	10,1	12	71	-	-	118	-	2
PLDIC205D102030IK	PLDIE205D102030IK	10,2	12	71	-	-	118	-	2
PLDIC205D103030IK	PLDIE205D103030IK	10,3	12	71	-	-	118	-	2
PLDIC205D104030IK	PLDIE205D104030IK	10,4	12	71	-	-	118	-	2
PLDIC205D105030IK	PLDIE205D105030IK	10,5	12	71	-	-	118	-	2
PLDIC205D106030IK	PLDIE205D106030IK	10,6	12	71	-	-	118	-	2
PLDIC205D107030IK	PLDIE205D107030IK	10,7	12	71	-	-	118	-	2
PLDIC205D108030IK	PLDIE205D108030IK	10,8	12	71	-	-	118	-	2
PLDIC205D109030IK	PLDIE205D109030IK	10,9	12	71	-	-	118	-	2
PLDIC205D110030IK	PLDIE205D110030IK	11,0	12	71	-	-	118	-	2
PLDIC205D111030IK	PLDIE205D111030IK	11,1	12	71	-	-	118	-	2
PLDIC205D112030IK	PLDIE205D112030IK	11,2	12	71	-	-	118	-	2
PLDIC205D113030IK	PLDIE205D113030IK	11,3	12	71	-	-	118	-	2
PLDIC205D114030IK	PLDIE205D114030IK	11,4	12	71	-	-	118	-	2
PLDIC205D115030IK	PLDIE205D115030IK	11,5	12	71	-	-	118	-	2
PLDIC205D116030IK	PLDIE205D116030IK	11,6	12	71	-	-	118	-	2
PLDIC205D117030IK	PLDIE205D117030IK	11,7	12	71	-	-	118	-	2
PLDIC205D118030IK	PLDIE205D118030IK	11,8	12	71	-	-	118	-	2
PLDIC205D119030IK	PLDIE205D119030IK	11,9	12	71	-	-	118	-	2



Other dimensions on request / Andere Abmessungen auf Anfrage

Dimensions in mm / Maße in mm

Solid carbide drill; 5xD; DIN6537L; with internal coolant holes; TiAlN-based coated

VHM Bohrer; 5xD; DIN6537L; mit Innenkühlung; TiAlN-basierte Schicht

Workpiece material groups and cutting speed / Werkstoffgruppen und Schnittgeschwindigkeiten

Material Material	Tensile strength Zugfestigkeit Rm [N/mm ²]	Hardness Härte [HB/HRC]	Cutting speed Vc [m/min] Schnittgeschwindigkeiten		
			min	opt	max
P1 Plain carbon steel / Unlegierter Stahl	< 600	< 230	-	-	-
P2 Alloy Steel / Legierter Stahl	< 1200	< 350	-	-	-
P3 High alloy steel and tool steel / Hochlegierter Stahl und Werkzeugstahl	< 1400	< 380	-	-	-
M1 Aust. and Ferr. Stainless steel / Aust. und Ferr. rostfreie Stähle	< 680	< 220	60	70	80
M2 Mart. Stainless steel / Mart. rostfreie Stähle	< 820	< 240	60	70	80
K1 Grey cast iron / Grauguß	-	< 280	-	-	-
K2 Ductile cast iron / Sphäroguß	-	< 320	-	-	-
N1 Non-ferrous alloys / Nichteisenmetalle	< 250	< 110	-	-	-
N2 Aluminium alloys / Aluminiumlegierungen	< 530	< 130	-	-	-
S1 High temperature alloys Fe, Ni and Co based / Warmfeste Leg. Fe, Ni und Co	< 3300	< 350	30	40	50
S2 Titanium alloys; Alpha and Beta / Titan Legierungen Alpha und Beta	< 2100	< 400	30	40	50
H1 Hardened steel / Gehärtete Stähle	-	< 54 HRC	-	-	-
H2 Hardened steel / Gehärtete Stähle	-	52-60 HRC	-	-	-
H3 Hardened steel / Gehärtete Stähle	-	> 58 HRC	-	-	-
G1 Graphite / Graphit	-	-	-	-	-

Cutting conditions / Zerspanungswerte

Material Material	f Feed per revolution [mm] / Vorschub pro Umdrehung [mm]										
	Ø 0 - 2	Ø 2 - 2,5	Ø 2,5 - 3	Ø 3 - 4	Ø 4 - 5	Ø 5 - 6	Ø 6 - 8	Ø 8 - 10	Ø 10 - 12	Ø 12 - 16	Ø 16 - 20
P1	0,080	0,100	0,125	0,160	0,160	0,200	0,250	0,315	0,315	0,400	0,500
P2	0,063	0,080	0,100	0,125	0,125	0,160	0,200	0,250	0,250	0,315	0,400
P3	0,050	0,063	0,080	0,100	0,100	0,125	0,160	0,200	0,200	0,250	0,315
M1	0,040	0,050	0,063	0,080	0,080	0,100	0,125	0,160	0,160	0,200	0,250
M2	0,032	0,040	0,050	0,063	0,063	0,080	0,100	0,125	0,125	0,160	0,200
K1	0,125	0,160	0,160	0,200	0,250	0,315	0,315	0,400	0,500	0,630	0,630
K2	0,100	0,125	0,160	0,200	0,200	0,250	0,315	0,400	0,400	0,500	0,630
N1	0,100	0,125	0,160	0,200	0,200	0,250	0,315	0,400	0,400	0,500	0,630
N2	0,125	0,160	0,160	0,200	0,250	0,315	0,315	0,400	0,500	0,630	0,630
S1	0,040	0,050	0,063	0,080	0,080	0,100	0,125	0,160	0,160	0,200	0,250
S2	0,032	0,040	0,050	0,063	0,063	0,080	0,100	0,125	0,125	0,160	0,200
H1	0,032	0,040	0,050	0,063	0,063	0,080	0,100	0,125	0,125	0,160	0,200
H2	0,025	0,032	0,040	0,050	0,050	0,063	0,080	0,100	0,100	0,125	0,160
H3	-	-	-	-	-	-	-	-	-	-	-
G1	-	-	-	-	-	-	-	-	-	-	-

Solid carbide drill; 5xD; DIN6537L; with internal coolant holes; TiAlN-based coated
 VHM Bohrer; 5xD; DIN6537L; mit Innenkühlung; TiAlN-basierte Schicht

Specifications / Spezifikationen

DIN 6535 HA	DIN 6535 HE	Dc	Ds	Ls	Ln	Dn	Lt	r	z
PLDIC205D120030IK	PLDIE205D120030IK	12,0	12	71	-	-	118	-	2
PLDIC205D122030IK	PLDIE205D122030IK	12,2	14	77	-	-	124	-	2
PLDIC205D125030IK	PLDIE205D125030IK	12,5	14	77	-	-	124	-	2
PLDIC205D127030IK	PLDIE205D127030IK	12,7	14	77	-	-	124	-	2
PLDIC205D128030IK	PLDIE205D128030IK	12,8	14	77	-	-	124	-	2
PLDIC205D130030IK	PLDIE205D130030IK	13,0	14	77	-	-	124	-	2
PLDIC205D133030IK	PLDIE205D133030IK	13,3	14	77	-	-	124	-	2
PLDIC205D135030IK	PLDIE205D135030IK	13,5	14	77	-	-	124	-	2
PLDIC205D137030IK	PLDIE205D137030IK	13,7	14	77	-	-	124	-	2
PLDIC205D140030IK	PLDIE205D140030IK	14,0	14	77	-	-	124	-	2
PLDIC205D142030IK	PLDIE205D142030IK	14,2	16	83	-	-	133	-	2
PLDIC205D143030IK	PLDIE205D143030IK	14,3	16	83	-	-	133	-	2
PLDIC205D145030IK	PLDIE205D145030IK	14,5	16	83	-	-	133	-	2
PLDIC205D147030IK	PLDIE205D147030IK	14,7	16	83	-	-	133	-	2
PLDIC205D150030IK	PLDIE205D150030IK	15,0	16	83	-	-	133	-	2
PLDIC205D152030IK	PLDIE205D152030IK	15,2	16	83	-	-	133	-	2
PLDIC205D153030IK	PLDIE205D153030IK	15,3	16	83	-	-	133	-	2
PLDIC205D155030IK	PLDIE205D155030IK	15,5	16	83	-	-	133	-	2
PLDIC205D157030IK	PLDIE205D157030IK	15,7	16	83	-	-	133	-	2
PLDIC205D160030IK	PLDIE205D160030IK	16,0	16	83	-	-	133	-	2
PLDIC205D163030IK	PLDIE205D163030IK	16,3	18	93	-	-	143	-	2
PLDIC205D165030IK	PLDIE205D165030IK	16,5	18	93	-	-	143	-	2
PLDIC205D169030IK	PLDIE205D169030IK	16,9	18	93	-	-	143	-	2
PLDIC205D170030IK	PLDIE205D170030IK	17,0	18	93	-	-	143	-	2
PLDIC205D173030IK	PLDIE205D173030IK	17,3	18	93	-	-	143	-	2
PLDIC205D175030IK	PLDIE205D175030IK	17,5	18	93	-	-	143	-	2
PLDIC205D180030IK	PLDIE205D180030IK	18,0	18	93	-	-	143	-	2
PLDIC205D185030IK	PLDIE205D185030IK	18,5	20	93	-	-	153	-	2
PLDIC205D189030IK	PLDIE205D189030IK	18,9	20	101	-	-	153	-	2
PLDIC205D190030IK	PLDIE205D190030IK	19,0	20	101	-	-	153	-	2
PLDIC205D193030IK	PLDIE205D193030IK	19,3	20	101	-	-	153	-	2
PLDIC205D195030IK	PLDIE205D195030IK	19,5	20	101	-	-	153	-	2
PLDIC205D200030IK	PLDIE205D200030IK	20,0	20	101	-	-	153	-	2





PREMIUMLINE
SOLID CARBIDE DRILLS [®]



Improving Quality Through Innovation

Product of Holland

UK

▶ Technical information Solid Carbide Drills

D

▶ Technische Informationen VHM Bohrer



Improving Quality Through Innovation

Product of Holland

Shank and adapter specifications

Schaft und Spannflächen Spezifikation

Cylindrical shank DIN 6535 form HA and HE / Zylinderschaft nach DIN 6535 Form HA und HE

without flat ohne Spannfläche		with flat mit Spannfläche					
d_{1h6}	L_1	b_1	h_{1h11}	h_{2h11}	L_2	L_3	r_2
6	36	4,3	5,1	5,1	25	18	1,2
8	36	5,5	6,9	6,9	25	18	1,2
10	40	7,1	8,5	8,5	28	20	1,2
12	45	8,2	10,4	10,4	33	22,5	1,2
14	45	8,1	12,7	12,7	33	22,5	1,2
16	48	10,1	14,2	14,2	36	24	1,6
18	48	10,8	16,2	16,2	36	24	1,6
20	50	11,4	18,2	18,2	38	25	1,6

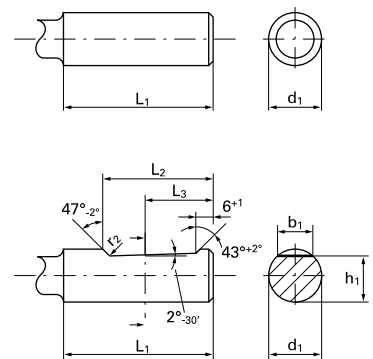

Adapter type DIN 1835 form E / Werkzeughalter Typ DIN 1835 Form E

d_{1h5}	d_2	d_3	d_4	f_1	L_3
6	25	M6	8	1,0	35
8	28	M8	10	1,3	35
10	35	M10	12	1,5	39
12	42	M12	14	1,6	44
14	44	M12	14	1,6	44
16	48	M14	16	1,7	47
18	50	M14	16	1,7	47
20	52	M16	18	2,1	49

Screw size/opt. torque Schraube/ opt. Drehmoment

M6	5 Nm
M8	10 Nm
M10	16 Nm
M12	28 Nm
M14	42 Nm
M16	50 Nm

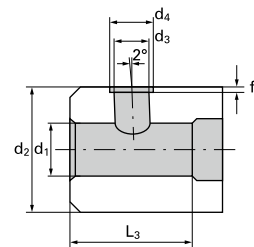

Drill specifications Bohrer Spezifikationen

List of abbreviations / Bedeutung der Abkürzungen

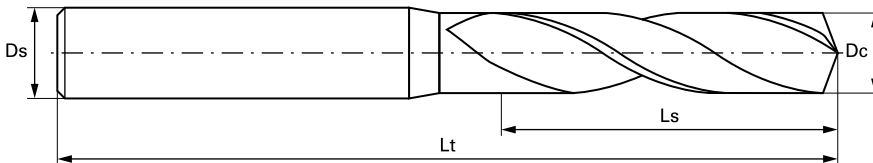

Dc Cutting diameter / Durchmesser Schneide

Ds Shank diameter / Durchmesser Schaft

Ls Flute length / Nutlänge

Lt Total length / Gesamtlänge

Tolerances according to DIN 7160 and 7161 / Toleranz nach DIN 7160 und 7161

	$\varnothing > 1 - 3$	$\varnothing > 3 - 6$	$\varnothing > 6 - 10$	$\varnothing > 10 - 18$	$\varnothing > 18 - 30$
m7	-	+0,016	+0,021	+0,025	+0,029
	-	+0,004	+0,006	+0,007	+0,008
h7	0	0	0	0	0
	-0,010	-0,012	-0,015	-0,018	-0,021
h6	0	0	0	-	-
	-0,006	-0,008	-0,009	-0,011	-0,013

Problems and solutions

Anwendungsprobleme und Lösungsansätze

Chipping of drillpoint edges / Eckenverschleiß / Eckenausbrüche

- Check toolholder (runout <0,02 mm) / Spannmittel überprüfen (Rundlauf <0,02 mm)
- Use hydraulic toolholder / Hydrodehnspannfutter verwenden
- Check machine workspindel (runout <0,02 mm) / Maschinenspindel überprüfen (Rundlauf <0,02 mm)
- Check workpiece clamping / Werkstückspannung überprüfen
- Check coolant situation / Kühlsituation überprüfen
- Check feed and cutting speed / Vorschubwerte und Drehzahl überprüfen
- Spotdrill point angle > Drill point angle / Vorzentrieren = Zentrierwinkel > als Bohrspitzenwinkel

Webedge wear / Verschleiß der Querschneide

- Check toolholder (runout <0,02 mm) / Spannmittel überprüfen (Rundlauf <0,02 mm)
- Use hydraulic toolholder / Hydrodehnspannfutter verwenden
- Check machine workspindel (runout <0,02 mm) / Maschinenspindel überprüfen (Rundlauf <0,02 mm)
- Check workpiece clamping / Werkstückspannung überprüfen
- Check feed and cutting speed / Vorschubwerte und Drehzahl überprüfen

Cutting edge wear / Verschleiß an der Hauptschneide

- Check toolholder (runout <0,02 mm) / Spannmittel überprüfen (Rundlauf <0,02 mm)
- Use hydraulic toolholder / Hydrodehnspannfutter verwenden
- Check machine workspindel (runout <0,02 mm) / Maschinenspindel überprüfen (Rundlauf <0,02 mm)
- Check workpiece clamping / Werkstückspannung überprüfen
- Check coolant situation / Kühlsituation überprüfen (keine Temperaturschwankungen)
- Check feed and cutting speed / Vorschubwerte und Drehzahl überprüfen

Excessive wear outside diameter / Verschleiß / Ausbrüche an der Führungsfasen

- Check toolholder (runout <0,02 mm) / Spannmittel überprüfen (Rundlauf <0,02 mm)
- Use hydraulic toolholder / Hydrodehnspannfutter verwenden
- Check machine workspindel (runout <0,02 mm) / Maschinenspindel überprüfen (Rundlauf <0,02 mm)
- Check stability CNC machine / Stabilität der Maschine überprüfen
- Check workpiece clamping / Werkstückspannung überprüfen
- Check coolant situation / Kühlsituation überprüfen
- Change to other drill geometry / Wahl des Werkzeugs überprüfen
- Check feed and cutting speed / Vorschubwerte und Drehzahl überprüfen

Tool breakage / Werkzeugbruch

- Check toolholder (runout <0,02 mm) / Spannmittel überprüfen (Rundlauf <0,02 mm)
- Use hydraulic toolholder / Hydrodehnspannfutter verwenden
- Check machine workspindel (runout <0,02 mm) / Maschinenspindel überprüfen (Rundlauf <0,02 mm)
- Check stability CNC machine / Stabilität der Maschine überprüfen
- Check workpiece clamping / Werkstückspannung überprüfen
- Change to other drill geometry / Wahl des Werkzeugs überprüfen
- Check feed and cutting speed / Vorschubwerte und Drehzahl überprüfen
- Check chip evacuation (long chips?) / Spanabfuhr überprüfen

Cutting formulas Zerspanungsformeln

Cutting speed / Schnittgeschwindigkeit

$$V_c = \frac{D_c \times \pi \times n}{1000} \quad [\text{m/min}]$$

- V_c** Cutting speed [m/min] / Schnittgeschwindigkeit [m/min]
D_c Cutting diameter [mm] / Durchmesser Schneide [mm]
n Revolutions per minute / Umdrehungen pro Minute
π Pi / Pi

Revolutions per minute / Umdrehungen

$$n = \frac{V_c \times 1000}{D_c \times \pi} \quad [\text{r.p.m.}]$$

- V_c** Cutting speed [m/min] / Schnittgeschwindigkeit [m/min]
D_c Cutting diameter [mm] / Durchmesser Schneide [mm]
n Revolutions per minute / Umdrehungen pro Minute
π Pi / Pi













Table feed rate / Tischvorschub

$$V_f = f \times n \quad [\text{mm/min}]$$

- V_f** Table feed [mm/min] / Tischvorschub [mm/min]
f Feed per revolution [mm] / Vorschub pro Umdrehung [mm]
n Revolutions per minute / Umdrehungen pro Minute

Legenda

Legende

	Material-coating combination Material-Beschichtung Kombination
	Specific tool geometry Spezifische Werkzeuggeometrie
	Semi-specific tool geometry Halb spezifische Werkzeuggeometrie
	Universal tool geometry Universal-Werkzeuggeometrie
	Max. drill depth Max. Bohrtiefe
	Tolerance cutting diameter Toleranz Durchmesser Schneide
	Tolerance shank diameter Toleranz Durchmesser Schaft
	Shank design Schaft Ausführung
	Point angle Spitzenwinkel
	Oil coolant Öl-Kühlung
	Without coolant holes Ohne Innenkühlung
	With coolant holes Mit Innenkühlung
	Material group Materialgruppe



Maximal economical tool life with SEP, the SCT Tools Eco Plan

Environmental awareness and cost effectiveness

Maximale Gebrauchsdauer mit SEP, dem SCT Tools Eco Plan

Umweltfreundlich & Kostensparend

Regrinding service
Nachschleifservice



Improving Quality Through Innovation

Product of Holland

UK

Maximal economical tool life with SEP, the SCT Tools Eco Plan

Inspired by the Ecosphere SCT developed SEP. SEP is SCT's own regrinding and recoating service with the purpose of extending the usage of your tools, thus relieving the pressure on the environment.

The SEP cycle consists of six individual steps in which quality, environment and costs are key values. Each tool will be thoroughly inspected upon receipt to make sure it follows the optimal flow within the grinding process. Self-evidently, all SCT Tools cutting tools will be grinded according to SCT factory specifications to reobtain their original quality.

To minimize the pressure on the environment all grinding remainder, rest materials and scrap are collected in an environmental friendly way and sent for recycling.

You will expand the economical tool life of your SCT Tools cutting tools up to 300% while saving up to 50% on your total tooling costs by regrinding and recoating these cutting tools according to the SEP system.

D

Maximale Gebrauchsdauer mit SEP, dem SCT Tools Eco Plan

Inspiriert durch die Ecosphere hat SCT Tools SEP entwickelt. SEP ist ein eigener Schleif- und Beschichtungsservice mit dem Ziel, die Gebrauchsdauer Ihrer SCT Tools Werkzeuge zu verlängern und somit die Umwelt zu entlasten.

Der SEP-Zyklus besteht aus sechs Fasen, wobei Qualität und Kosten im Vordergrund stehen. So wird jedes Werkzeug einer eingehenden Eingangskontrolle unterzogen, um somit einen möglichst optimalen Schleifverlauf zu durchlaufen. Danach werden Ihre SCT Tools Werkzeuge auf Basis der Herstellerspezifikationen geschliffen, so dass die originale Qualität gewährleistet wird.

Um die Umwelt zu entlasten, werden Schleifabfälle und Restmaterialien auf umweltfreundliche Art gesammelt und zum Recycling entsorgt.

Dadurch, dass Sie Ihre SCT Tools Werkzeuge mit dem SEP-System nachschleifen und beschichten lassen, verlängern Sie die Lebensdauer Ihrer Werkzeuge bis zu 300% und sparen bis zu 50% an Ihren gesamten Werkzeugkosten.

Saving with SEP / Einsparung mit SEP



An ecosphere is a by NASA developed glass sphere containing a completely sealed ecosystem with little creatures, algae, sand and pebbles. The organisms in an ecosphere function as a cycle in which the waste of one functions as the nutrient for another.

Eine Ecosphere ist eine durch die NASA entwickeltes aus Glas bestehendes, geschlossenes Ökosystem mit kleinen Tieren, Algen, Sand und Kiesel. Die Organismen in Ecospheren bilden zusammen ein System, das einen Kreislauf bildet durch den Gebrauch der jeweils anderen Abfallstoffe als Nährstoffe.

The advantages of SEP

- Regrinding according to SCT factory specifications
- Minimal waste of material with regrinding
- Simple recognition of the number of regrinds
- Detailed regrinding history through a barcode system
- Minimal setup time
- Save up to 50% on tooling costs
- Recycling of grinding remainder
- Extend tool usability up to 300%

Vorteile von SEP

- Aufbereitung nach originalen SCT Herstellerspezifikationen
- Minimaler Materialverlust bei Nachschleifen
- Einfaches Erkennen der Anzahl der Nachschleif-Sessions
- Präzise Nachschleif-Historie mittels Barcode System
- Minimale Einstellzeit
- Bis zu 50% Einsparung an Werkzeugkosten
- Recycling von Schleifabfall
- Verlängerung der Lebensdauer bis zu 300%

Comparison cost of new tool vs. SEP / Kostenverlauf Neu vs. SEP

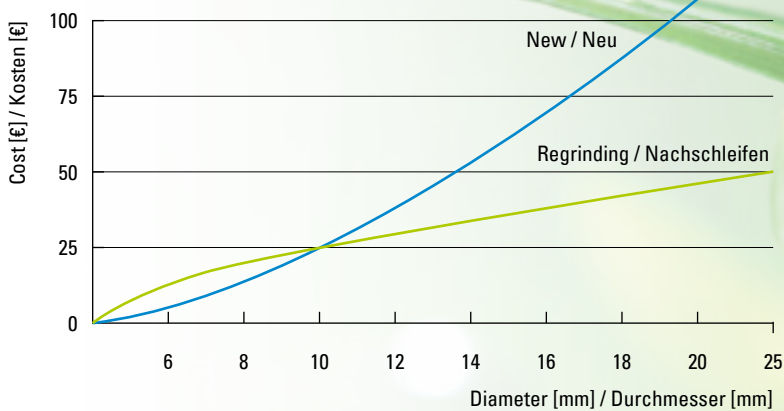

Quick and easy shipment with the SEP box

We offer you our SEP box to participate in the SCT ECO Plan. In these boxes you collect your stump tools. Once the SEP box is full and ready for transport, simply register the shipment at sep@sct-tools.com and we will arrange the pick up. The SEP box is available in two sizes: small and regular.

Schnell und einfach versenden mit der SEP-Box

Um den SCT Eco Plan zu benutzen, bieten wir unsere SEP-Boxen an. In diesen Boxen sammeln Sie die defekten Werkzeuge. Sobald die Box voll und versandfertig ist, melden Sie die Box bei uns an und schicken sie sicher zu uns. Die SEP-Box ist in 2 Abmessungen erhältlich.



Small / Klein
300 × 200 × 120 mm

Regular / Normal
400 × 300 × 230 mm

Original quality

To guarantee the original quality of SCT Tools cutting tools all tools are ground according to the original factory standards and recoated with the original coating.

Originalqualität

Um die Originalqualität von SCT Tools Werkzeugen zu garantieren, werden alle SCT Tools Werkzeuge nach der originalen Herstellergeometrie geschliffen und mit der Originalbeschichtung versehen.

SEP history

All incoming tools per SEP-session will be accurately registered. In this way it is easily traceable how often the tool has been offered for regrinding and recoating.

SEP Geschichte

Alle per SEP-Session eingehenden Werkzeuge werden genauestens registriert. So wird präzise festgehalten wie oft ein Werkzeug bereits nachgeschliffen wurde.





4 Regrinding & Coating / Nachschliff & Beschichtung

All SCT Tools cutting tools are being reshaped according to original SCT geometries. If necessary, tools will be coated to match the original specifications.

Alle Ihre SCT Tools Werkzeuge werden nach der originalen Herstellergeometrie nachgeschliffen und sofern notwendig auch mit der Originalbeschichtung versehen.



3 Inspection upon receipt / Eingangskontrolle

Once the tools have been received at SCT they will be thoroughly inspected and registered to be tracked and traced at all times.

Sobald Ihre Werkzeuge bei uns eintreffen, werden diese durch eine gründliche Eingangskontrolle analysiert. Danach werden diese registriert, so dass Track & Trace jederzeit möglich ist.



2 Registration & Pick up / Anmelden & Versenden

Send an e-mail to sep@sct-tools.com containing the number of SEP boxes and the total weight of the shipment when they are ready for pick up. A courier will pick up the shipment the next day.

Via sep@sct-tools.com melden Sie die Anzahl an SEP-Boxen sowie das Gesamtgewicht der zur Abholung vorliegenden Werkzeuge an. Ein Kurier holt diese dann am Folgetag bei Ihnen ab.



How does SEP work?

1. Order a SEP box
2. Collect stump tools in the SEP box
3. Register the quantity of SEP boxes and the total weight of the shipment via sep@sct-tools.com
4. After receipt of your pick-up registration SCT Tools will take care of the pickup and return of the SEP box with the help of a courier service.

* In addition to your SCT tools we also sharpen all your other stump cutting tools.

5 Quality monitoring & Certification / Kontrolle & Zertifizierung

After regrinding and coating the quality of the tools will be inspected and when desired they will be provided with a measurement report.

Nach dem Scharfschleifen und Beschichten der Werkzeuge wird die Qualität kontrolliert und die nachgeschliffenen Werkzeuge auf Wunsch mit einem Messprotokoll versehen.



6 Tool return / Rücksendung

All tools will be packed in a SEP box and shipped back to you by the same courier service.

Alle Werkzeuge werden in der SEP-Box durch denselben Kurierdienst an Sie zurückgesandt.



1 Collect / Sammeln

Order your SEP-Box with the desired dimensions and collect your stump tools in this box.

Bestellen Sie eine SEP-Box in der gewünschten Abmessung und sammeln Sie die defekten Werkzeuge in der SEP-Box.



Wie funktioniert SEP?

1. SEP-Box bestellen
2. Werkzeuge in der SEP-Box sammeln
3. SEP-Box(en) anmelden und das Gewicht mitteilen über: **sep@sct-tools.com**
4. Nach dem Erhalt der E-Mail kümmert sich SCT Tools um die Abholung und den Versand der SEP-Box(en) durch einen Kurier

* Neben Ihren SCT Werkzeugen schleifen wir auch alle andere Arten defekter Werkzeuge für Sie nach.

Special cutting tools

SCT Tools is a dynamic organization dedicated to the development and production of multiple product lines of solid carbide end mills and drills as well as the manufacturing of custom made cutting tools.

The custom made cutting tools are developed and produced in house and when desired will be technically supported and fitted into your production process.

Our well-trained staff engineers and produces these custom made tools supported following the most enhanced and innovative production methods. SCT Tools offers a wide range of custom made cutting tools with some examples being: HSS and solid carbide step drills and profile end mills, brazed carbide tools and insert tools.

The client portfolio for our custom made tooling comes from a variety of industries such as the automotive, tooling and aerospace as well as the machine building and heavy machining industry.

All SCT Tools custom made tooling will be able to be treated according to the SCT ECO Plan. This makes sure you have the optimal aftercare for your valuable custom made cutting tools as well.

Special Tooling

SCT Tools ist eine dynamische Organisation, welche neben der Entwicklung und Produktion von VHM Fräsern und VHM Bohrern auch Hersteller von Sonderwerkzeugen ist.

Diese Sonderwerkzeuge werden im eigenen Hause entwickelt und produziert und sofern gewünscht, in den Produktionsprozess des Kunden eingefügt.

Unsere gut ausgebildeten Mitarbeiter konstruieren und produzieren die Sonderwerkzeuge durch die verschiedensten, innovativen Produktionsmethoden. Einige Beispiele van Sonderwerkzeugen sind: HSS und VHM Profilbohrer und -fräser, HM-bestückte Werkzeuge und Wendepplatten-Werkzeuge.

Abnehmern unserer Sonderwerkzeuge sind in der Automobil-, Verfahrens-, Werkzeug- und Luftfahrtindustrie zu finden sowie ebenfalls im Maschinenbau und der Schwerzerspanung.

Auch für die durch uns produzierten Sonderwerkzeuge können Sie von dem SCT Eco Plan Gebrauch machen. Hierdurch wird eine stets optimale Aufbereitung Ihrer wertvollen Sonderwerkzeuge gewährleistet.

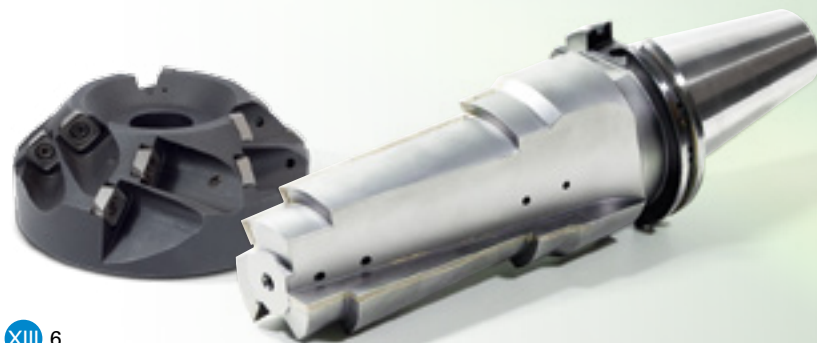

SCT has a global network of professional dealers
SCT verfügt über ein globales Netzwerk von professionellen Händlern

Dealer / Händler



Improving Quality Through Innovation

Product of Holland

SCT TILBURG B.V. | Jellinghausstraat 30 | 5048 AZ Tilburg - The Netherlands
Tel. +31 (0)13 531 00 80 | Fax. +31 (0)13 531 00 89 | sales@sct-tools.com | www.sct-tools.com